

# Biocor Series

AODD STAINLESS-STEEL PUMPS FOR STERILE APPLICATIONS  
PRODUCT BROCHURE



**ALMATEC®**

Where Innovation Flows

Almatec® Biocor Series Air-Operated Double-Diaphragm (AODD) Pumps have been specifically designed for critical sterile applications within the pharmaceutical, biotech and food industries. Biocor Series pumps are EHEDG certified and materials conform to EC1935/2004, FDA, USP Class VI and ATEX requirements. The special design of the fluid path enables the CIP and SIP capability.

CERTIFIED FOR  
HYGIENIC DESIGN  
AND CLEANABILITY



## Pump Models:

**B20:** Max. capacities of 3.5 m<sup>3</sup>/h (15.4 gpm)

**B32:** Max. capacities of 7.5 m<sup>3</sup>/h (33 gpm)

**B40:** Max. capacities of 17 m<sup>3</sup>/h (75 gpm)

## Almatec® Biocor Series AODD Stainless-Steel Pumps for Sterile Applications

- Air-operated double-diaphragm pump for sterile applications within pharmaceutical, biotechnical and food industry
- Built in accordance to the essential specifications (EHEDG, FDA, CLASS VI, etc.)
- Integrated cleaning-system with EHEDG-proven cleaning results
- CIP (clean in place) and SIP (sterilization in place) capabilities
- ATEX conformity
- Wetted materials made of SS316L (Basel Standard II) to ≤ 0.4 µm (15.75 µin)
- Sterile design: no horizontal areas
- Drainage of the pump by magnetical lifting of the valve balls from the outside (B20 and B32 only)
- Diaphragm monitoring sensor included as standard
- Diaphragms, ball valves and O-rings made of PTFE or EPDM (FDA conform)
- Maintenance-free air control system PERSWING P® without dead spot
- Gentle displacement
- No drives, no rotating parts, no shaft seals within the fluid
- Short-term temperature range up to 130 °C (266 °F) for SIP, long-term up to 80 °C (176 °F)
- Easy to start up, step-less control via the air volume and pressure
- Proof against dry running
- Self priming
- Suction and discharge ports suitable for Tri-Clamp® and other sanitary threads

# Biocor Series | Special Features

## Materials

The Biocor series is available in three pump sizes B20, B32 and B40. The material for the wetted housing parts is electropolished 1.4435/SS316L (Basel Standard II, ferrite content < 1%) with a surface roughness of  $\leq 0.4 \mu\text{m}$  (15.75  $\mu\text{in}$ ). The frame is made of 1.4404/SS316L and the center block of polyethylene conductive. The suction and discharge ports are suitable for Tri-Clamp® or different sanitary threads (DIN 11851, DIN 11864).

The diaphragms, ball valves and O-rings are made of PTFE or EPDM (FDA); other materials on request.



## Sterile Design With No Horizontal Areas

Always a demand for sterile applications: all housing parts of the Biocor pumps show no horizontal areas. Each pump of the B20 and B32 sizes comes with four ball lifting magnets, which can be attached to the pump housing from the outside at the location of the four ball valves. The ball valves are risen up magnetically out of their seats and the pump is drained entirely without having to be dismantled. There are no mechanical ball lifters with parts and seals in the wetted area.

Soft redirections without rotating parts and shaft seals in the product chamber together with the principle-related gentle displacement result in a special suitability for the supposed applications.

Due to the EHEDG requirements all Biocor pumps are equipped with a diaphragm monitoring sensor in the muffler as standard. It detects all liquids and in case of a diaphragm rupture it outputs a corresponding signal to a controller, which then triggers an alarm or disconnects the pump via a connected solenoid valve.

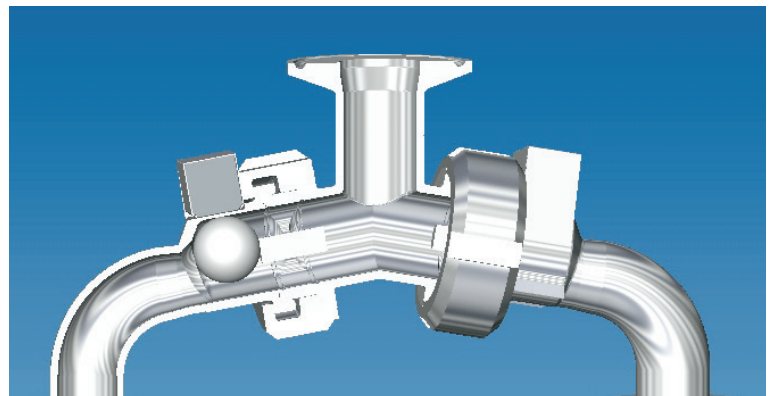

## Code System

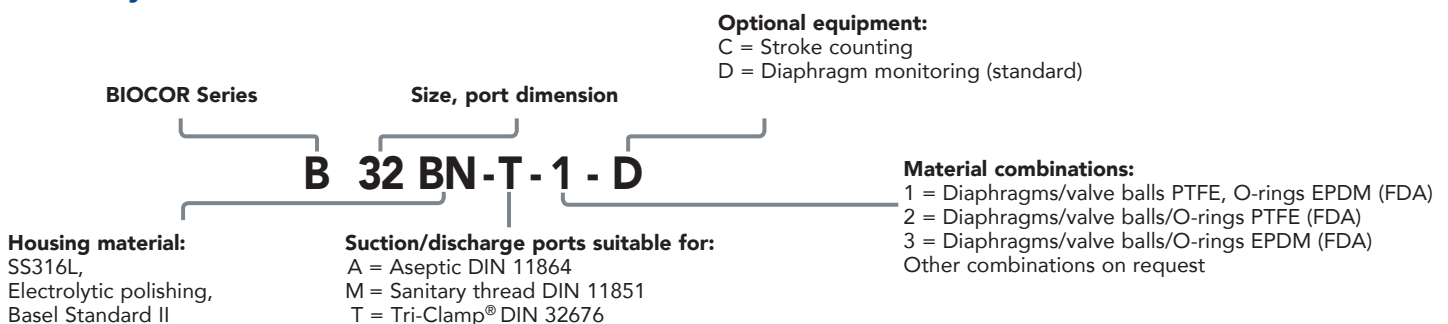



### PUMP HOUSING

- Wetted housing part
- Material: SS316L, (1.4435), electropolished,
- Basel Standard II, ferrite content < 1%
- Surface roughness of  $\leq 0.4 \mu\text{m}$  (15.75  $\mu\text{in}$ )

### CENTER BLOCK

- Solid construction
- Non-wetted housing part
- Material: Conductive Polyethylene

### BALL VALVES

- Robust and insensitive to solids
- Available materials:
  - EPDM (FDA)
  - PTFE (FDA)

### DIAPHRAGMS

- Integrated metal core, no diaphragm disc
- Designed for long service life
- Available materials:
  - EPDM (FDA)
  - PTFE/EPDM compound (FDA)

### SUCTION AND DISCHARGE PORTS

- Same material as pump housing
- Suitable for Tri-Clamp® or different sanitary threads

### PERWING P® AIR CONTROL SYSTEM

- Accurate reversal of the main piston
- Metal-free, low noise level
- No dead center
- Easy replacement of the complete cartridge

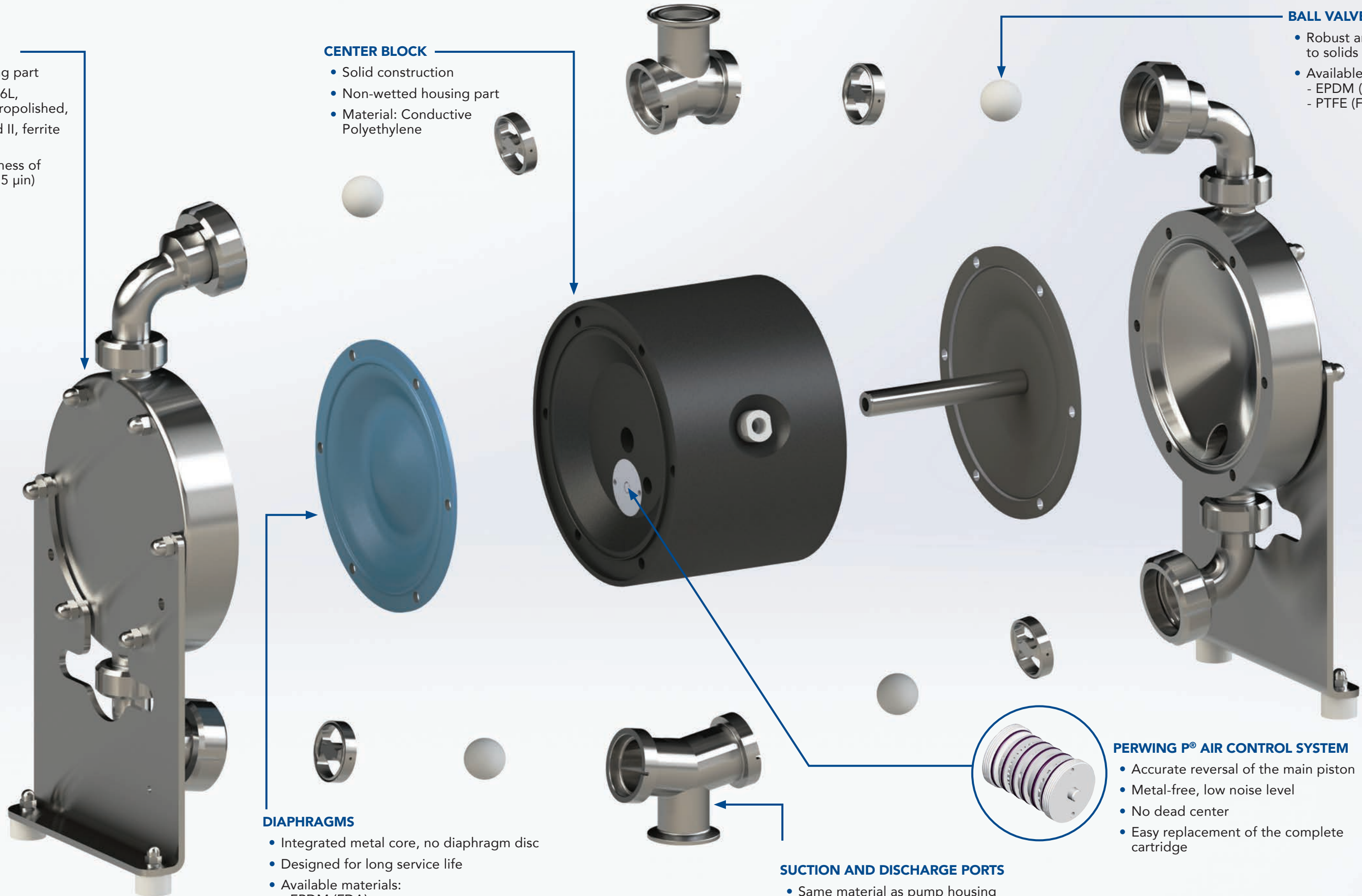

## Technical Data

		B20	B32	B40
Dimension (mm/inch):	length	244 (9.6)	284 (11.2)	462 (18.2)
	width	150 (5.9)	200 (7.9)	270 (10.6)
	height	381 (15)	484 (19)	681 (26.8)
Nominal port size (depends of the choosen suction and discharge connection)		DN 20	DN 32	DN 40
Air connection, BSP		1/4"	1/4"	1/2"
Weight (kg/lbs)		12 (27)	26 (57)	67 (147)
Max. particle size of solids (mm/inch)		3 (0.12)	5 (0.20)	9 (0.35)
Suction lift, dry (mWC/ftWC)		2 (6.6)	2.5 (8.2)	3 (9.8)
Suction lift, wet (mWC/ftWC)		9 (29.5)	9 (29.5)	9 (29.5)
Max. driving and operating pressure (bar/psig)		7 (100)	7 (100)	7 (100)
Max. operating temperature (°C/°F)		80 (176)	80 (176)	80 (176)
Max. capacities	m <sup>3</sup> /h	3.5	7.5	17
	l/min	58	125	283
	gpm	15	33	75



## Optional Equipment

### Stroke counting (code C)

A sensor is installed in the center block of the pump to count the strokes. The diaphragm movement is scanned without contact. The issued sensor pulses can be output to existing detectors or to a stroke counter (can also be supplied). When the preset value is reached, the stroke counter outputs a signal which can then be processed further, for instance in order to shut down the pump via a solenoid valve.

### Active Pulsation Dampers

Due to their design, pumps with oscillating action produce a pulsating flow. Although the double-acting design of the Biocor pumps and the direct pneumatic drive have already greatly reduced the pulsation, a pulsation damper must still be installed on the discharge side in order to obtain a virtually uniform flow. The available Almatec dampers are self-regulating.

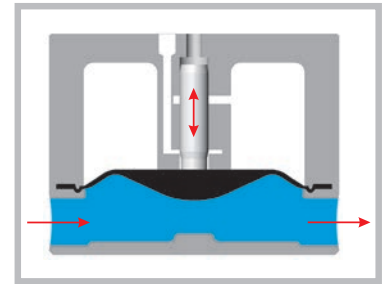

### Spare Part Kits

Spare parts kits ensure that the correct replacement parts are always available in the required quantities. This helps to avoid production stoppages and ensures that the Almatec air-operated double diaphragm pumps are always ready for action. We strongly recommend not to install non-genuine spare parts into your Almatec pumps and pulsation dampers. Any certificates on material conformity according to FDA, EC1935/2004 or USP VI and all EHEDG, CE- and ATEX-certificates for our products are invalid when using spare parts of non-genuine origin.



# Biocor Series Pump | Performance Charts

The following data refer to water at 20°C / 68°F (referring to DIN EN ISO 9906). The green lines state the air consumption (in Nm<sup>3</sup>/min, independent from the pressure).

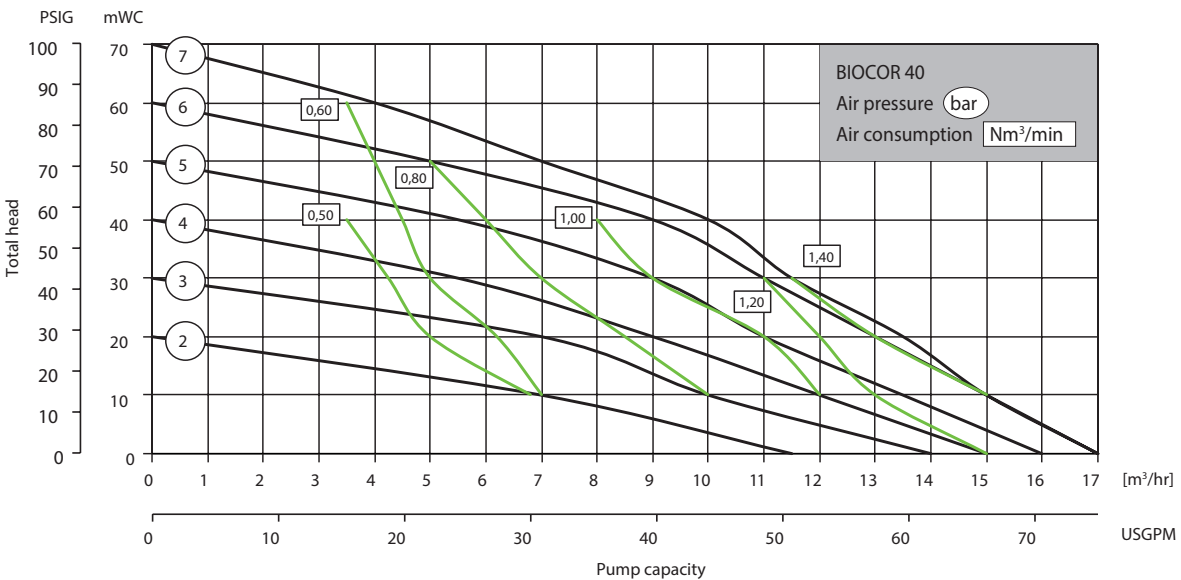
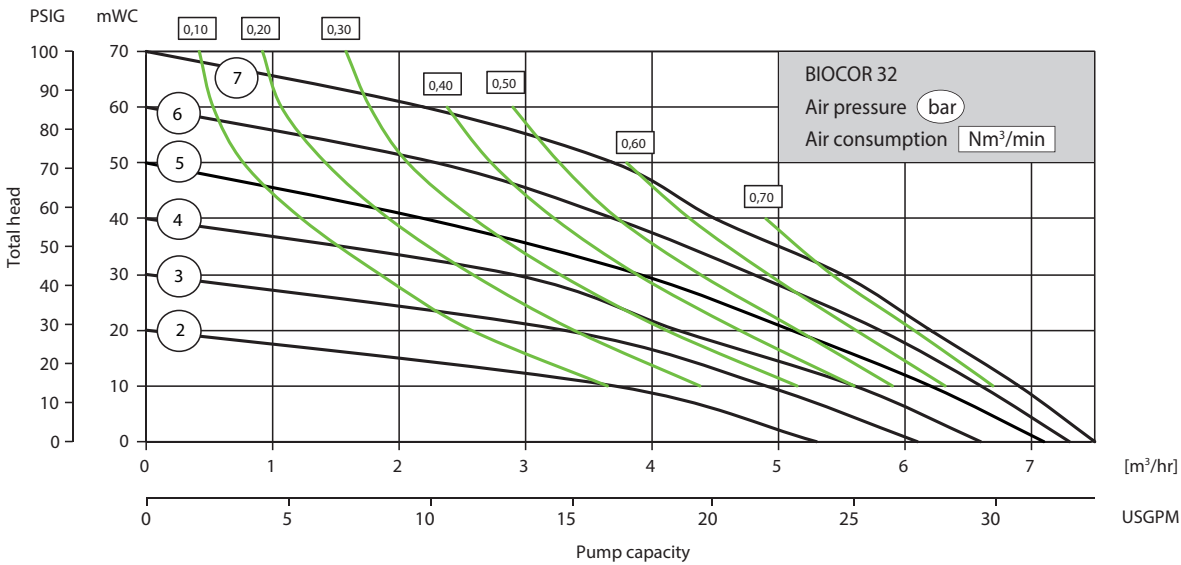
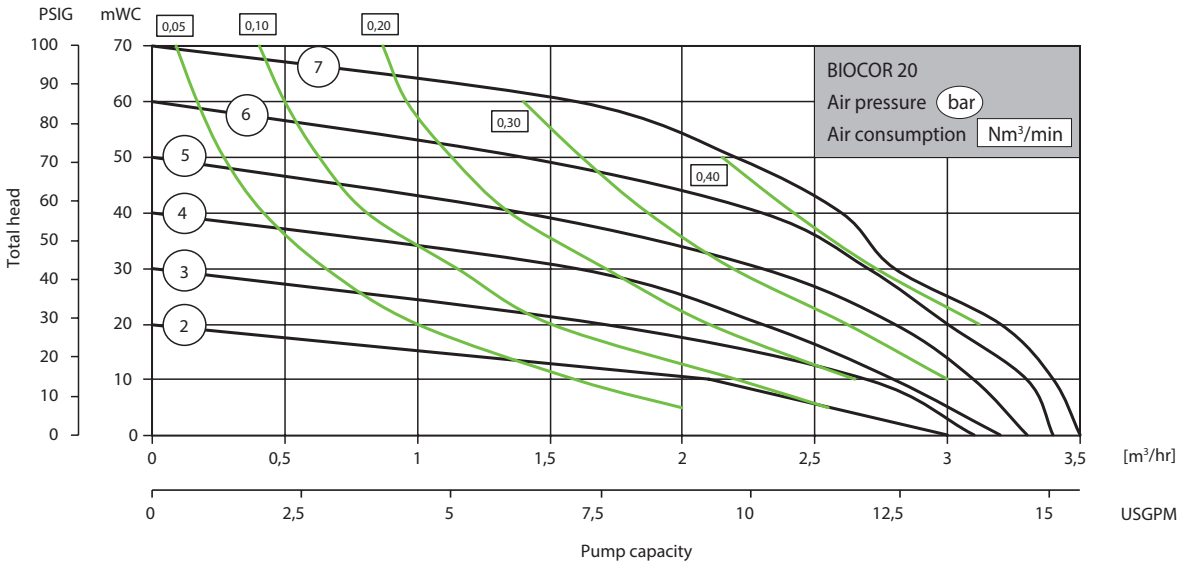

**ALMATEC®**

PSG Germany GmbH  
Hochstraße 150-152  
47228 Duisburg, Germany  
P: +49 (2065) 89205-0  
info@almatec.de  
almatec.de



Where Innovation Flows

ALM-40000-C-04

Authorized PSG® Partner:

Copyright 2021 PSG®, a Dover company