

Futur Series

SPECIAL AODD PUMPS FOR THE SEMICONDUCTOR INDUSTRY
PRODUCT BROCHURE



ALMATEC®

Where Innovation Flows

Since 1991 Almatec® manufactures pumps of the Futur family, which are designed specifically for chemical supply and circulation in the semiconductor industry. The liquids handled in the semiconductor industry have different demands, requiring a unique pump to meet those demands. Today the 4th generation of Futur pumps is manufactured. All generations are drop-in interchangeable in connections.

EXPERT SOLUTIONS FOR THE SEMICONDUCTOR INDUSTRY

Almatec® Futur Series

Dedicated AODD Pumps for the Semiconductor Industry

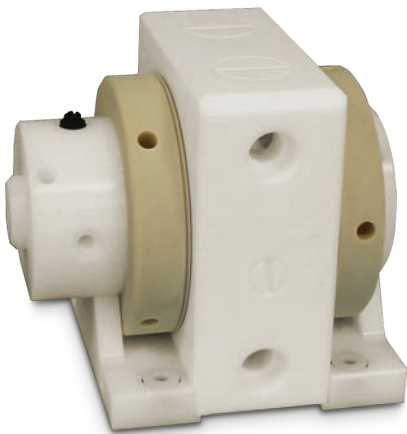

- Four material versions (T, H, E, S/SH) for different applications
- All plastic models contain no metal (T, H, E)
- Temperature range up to 200°C/392°F (H)
- Contactless cascade sealing between the product chambers
- No O-ring sealing in wetted areas
- Straight-through flow pattern, only one wetted housing part
- PERSWING P® air control system requires no lubrication or maintenance
- Internal air flow
- One-piece full PTFE diaphragms with optimized geometry
- Cylinder valves with surface sealing
- Compact, simple design with few parts, very low space required
- Housing and diaphragms machined from solid blocks
- Easy to dismantle and assemble
- No elements to fix, such as tie rods or clamps
- Separate pulsation damper available for all materials and sizes, can be retrofitted without dismantling of pump and piping
- Optional diaphragm and/or stroke sensors
- Self-priming
- Low noise level
- Assembled in a clean-room line

Futur Series | Special Features

Highlights of Design

Futur Series pumps are self-priming air-operated diaphragm pumps and can be easily controlled via the air volume. The liquid flows straight through the product chambers of the center housing, while the air control system and the air chambers are located in the side housing. This design ensures that only one part of the housing comes in contact with the liquid, reduces the number of flow bends to only two, minimizes the surface area, eliminates sliding parts in the product chambers, and makes it possible to dispense with gaskets. In the wetted area of the Futur pumps is no O-ring sealing.

There are no fastening elements, such as tie rods or clamps. The contactless cascade sealing between the product chambers is a major structural element. All the design features mentioned serve to minimize the generation of particles.

Futur pumps have a compact, simple design with few parts. The housing parts are machined from solid blocks, resulting in long-life operation. One-piece diaphragms are as well machined from massive PTFE slices. Suction and discharge ports are located at the front, thus simplifying installation in confined spaces.



Clean Room Assembly

All Futur parts are cleaned several times, prior to assembly and testing in a clean-room line.

Technical Data

Pump Size		10	20	50	100
Dimensions for plastic pumps in mm (inch)	length	185 (7.3)	201 (7.9)	246 (9.7)	303 (11.9)
	width	114 (4.5)	150 (5.9)	200 (7.9)	260 (10.2)
	height	131 (5.2)	168 (6.6)	216 (8.5)	266 (10.5)
Dimensions for stainless-steel pumps in mm (inch)	length	–	199 (7.8)	245 (9.6)	–
	width	–	124 (4.9)	174 (6.9)	–
	height	–	154 (6.1)	196 (7.7)	–
Nominal port size (NPT)		3/8"	1/2"	1"	1 1/4"
Air connection (NPT)*		1/4"	1/4"	1/4"	1/4"
Suction head, dry in mWC (ft.)		1 (3.3)	2.5 (8.2)	3.5 (11.5)	4 (13.1)
Suction head, wet in mWC (ft.)		8 (26.2)	9 (29.5)	9 (29.5)	9 (29.5)
Max. permissible driving pressure bar (psig)		6 (87)	6 (87)	6 (87)	6 (87)

* Futur S/SH: BSP

Max. permitted operating temperature

Pump Model	H	T	E	S	SH
at max. 6 bar (87 psig)	100°C 212°F	100°C 212°F	70°C 158°F	80°C 176°F	130°C 266°F
at max. 5 bar (73 psig)	130°C 266°F	110°C 230°F	70°C 158°F	80°C 176°F	130°C 266°F
at max. 4 bar (58 psig)	150°C 302°F	120°C 248°F	70°C 158°F	80°C 176°F	130°C 266°F
at max. 3 bar (44 psig)	180°C 356°F	130°C 266°F	70°C 158°F	80°C 176°F	130°C 266°F
at max. 2 bar (29 psig)	200°C 392°F	130°C 266°F	70°C 158°F	80°C 176°F	130°C 266°F

Model Futur T

When delivering acids and caustics, corrosion resistance is of the highest importance, so the center housing is constructed of special PTFE-TFM. Compared to normal PTFE, it has a higher tensile strength and surface density. Parts made of this material are smooth and free of pores, which results in reduced particle generation. The pumps are absolutely metal-free and can be used in temperature ranging up to 130°C (266°F).

Applications

- Acids, caustics, high purity chemicals
- Wet Benches, loops
- Supply, disposal, filtration, circulation

Materials

- Center housing: PTFE-TFM
- Side housings: Polyethylene

Pump Sizes & Performance

- 10T (10 l/min / 2.6 gpm)
- 20T (20 l/min / 5.3 gpm)
- 50T (50 l/min / 13 gpm)
- 100T (100 l/min / 26 gpm)



Model Futur E

The Futur E model has been designed to be abrasion-resistant, which is a requirement for pumping semiconductor polishing-slurries. To meet these operational demands, they are constructed of PE (polyethylene). It has a very high abrasion resistance (higher than steel), good impact value and withstands the introduction of slurry particles. Its good chemical properties allow handling both basic and acidic slurries. The Futur E is metal-free, with a maximum permitted liquid temperature of 70°C (158°F).

Applications

- Basic and acidic slurries
- Wafer polish (CMP)

Materials

- Center housing: Polyethylene
- Side housings: Polyethylene

Pump Sizes & Performance

- 20E (20 l/min / 5.3 gpm)
- 50E (50 l/min / 13 gpm)



SIDE HOUSING LEFT HAND

- Solid construction
- Non-wetted housing part
- Materials:
 - PTFE conductive (H)
 - Polyethylene (T, E)
 - Polyethylene conductive (S)
 - SS316 (SH)

DIAPHRAGMS

- Especially designed for the Futur pumps
- Machined one-piece design
- Small wetted surface
- Long service life
- Material: PTFE

CENTER HOUSING

- Solid construction
- Wetted housing part
- Materials:
 - PTFE-TFM (T, H)
 - Polyethylene (E)
 - SS316L (S/SH)

UNION NUTS

- Fixing element for the pump housings
- Same part on both side of the pump

SIDE HOUSING RIGHT HAND

- Solid construction
- Non-wetted housing part
- Materials:
 - PTFE conductive (H)
 - Polyethylene (T, E)
 - Polyethylene conductive (S)
 - SS316 (SH)

CASCADE SLEEVE

- Contactless cascade sealing between the product chambers
- No sliding surface in the liquid
- Material: PTFE-TFM

PERSWING P® AIR CONTROL SYSTEM

- Accurate reversal of the main piston without dead spot
- Pilot piston decoupled from the diaphragm stroke
- Low noise level
- No maintenance required
- Replacement as a complete cartridge, accessible from the outside



Model Futur H

Metal-free Futur H pumps have been designed to operate ideally in hot applications involving acids and caustics. The temperature limit is 200°C (390°F) at max. 2 bar (29 psig).

Applications

- Acids, caustics, high purity chemicals
- Wet Benches, loops
- Supply, disposal, filtration, circulation

Materials

- Center housing: PTFE-TFM
- Side housings: PTFE conductive

Pump Sizes & Performance

- 10H (10 l/min / 2.6 gpm)
- 20H (20 l/min / 5.3 gpm)

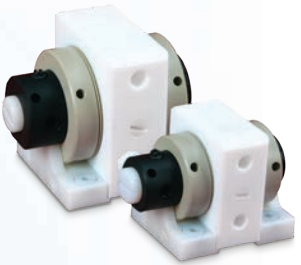

Model Futur S/SH

Futur S/SH pumps are constructed of stainless steel (316L) with extremely low carbon content. The housing parts are machined from a solid block of stainless steel and polished afterwards, the only way in which a pore-free surface can be secured.

The Futur S and Futur SH series differ in the material of the non-wetted side housings (PE conductive or SS316) and in the resulting maximum temperature of 80°C (176°F) or 130°C (266°F).

Applications

- Solvents
- Solvents mixtures
- Strippers

Materials

- Center housing: SS316L
- Side housings: PE conductive (Futur S)
SS316 (Futur SH)

Pump Sizes & Performance

- 20 S/SH (20 l/min / 5.3 gpm)
- 50 S/SH (50 l/min / 13 gpm)



Pulsation Dampers and Special Equipment

Due to their design, oscillating displacement pumps deliver a pulsating flow. This pulsation is considerably reduced by utilizing the appropriately designed air distribution channels and chambers of the Futur series, as well as by the cascade seal. Pulsation dampers (type D) of the same design without tie rods are available for all pump materials and sizes, if the remaining pulsation on the discharge side is unacceptable for a specific application. The installation of a pulsation damper is quick and easy, as it is simply screwed on top of the pump. Therefore, a separate pulsation damper can be retrofitted at any time, even on installed pumps, without changing the product connections.

Futur pumps can be fitted with a sensor installed in the muffler to **monitor the diaphragms**. A pneumatical **stroke counter** with a pressure transmitter registers the changes in pressure within the air chamber behind the diaphragm on the left-hand side.

Suction and discharge ports on the plastic Futur pumps can optionally be equipped with **Flaretek® connectors** for the piping system. For Futur S/SH models **VCR connectors** of stainless steel are available.

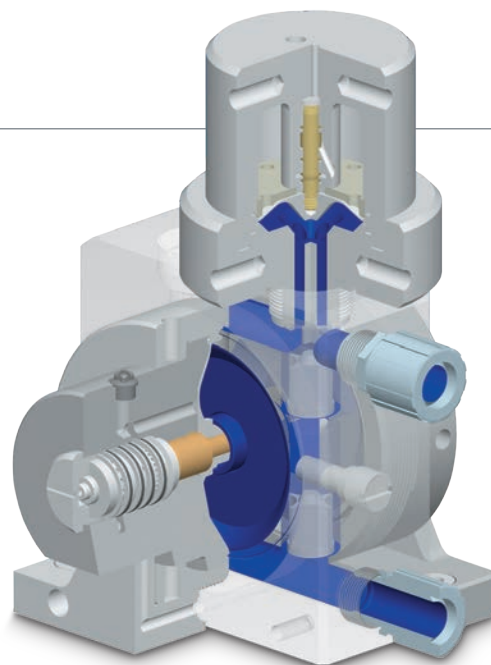

- **Diaphragm monitoring (Code D)**
- **Stroke counting (Code C)**
- **Flaretek® connectors (Code G)**
- **VCR connectors (Code V)**

Diaphragms and Cylinder Valves

Neither piston plates nor gaskets are required for the one-piece diaphragm machined from solid PTFE slices. The well-balanced geometry leads to an extremely long lifetime. The wetted surface is small, and does not contain any pockets in which particles may accumulate. In this respect, the Futur diaphragms differ considerably from sensitive bellows with their large surface and bends.

The pumps are equipped with the tried-and-tested cylinder valves. These valves seal a large area and ensure very good dry priming. They close gently and evenly and permit accurate delivery.



The PERSWING P® Air Control System

The main piston is accurately switched by the built-in air control system PERSWING P®. The pilot piston is decoupled from the diaphragm stroke and is operated only then at the end of the stroke like an indirect air control. There are no external controllers, limit switches and wiring. The patented PERSWING P® air control system does not require maintenance, operates without lubrication, and is characterized by a low noise level during operation.

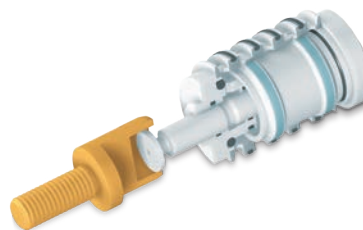

Spare Part Kits

Spare parts kits ensure that the correct replacement parts are always available in the required quantities. This helps to avoid production stoppages and ensures that the Almatec air-operated double diaphragm pumps are always ready for action. We strongly recommend not to install non-genuine spare parts into your Almatec pumps and pulsation dampers. Any certificates on material conformity and all CE- and ATEX-certificates for our products are invalid when using spare parts of non-genuine origin.



Futur Series | Performance Charts

The specified performance data are warranted by Almatec in accordance with DIN EN ISO 9906 as far as applicable. The data refers to water. The blue lines state the air consumption (in Nm³/h, independent from the pressure).

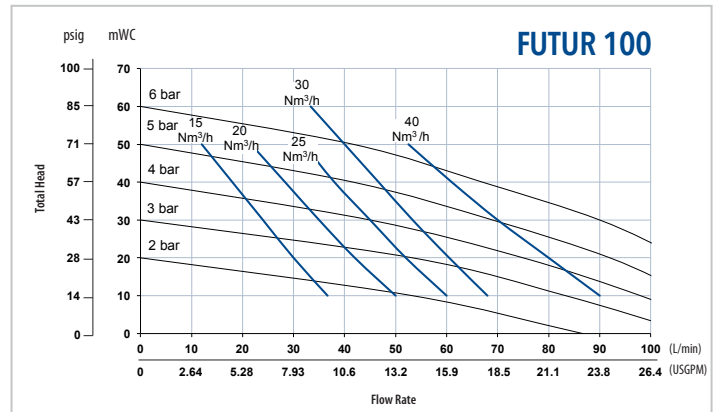
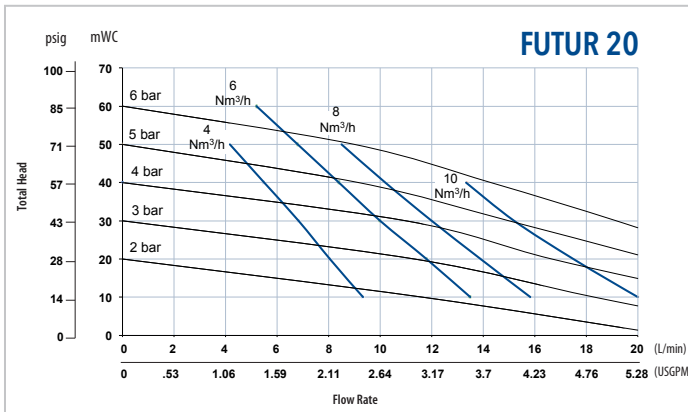
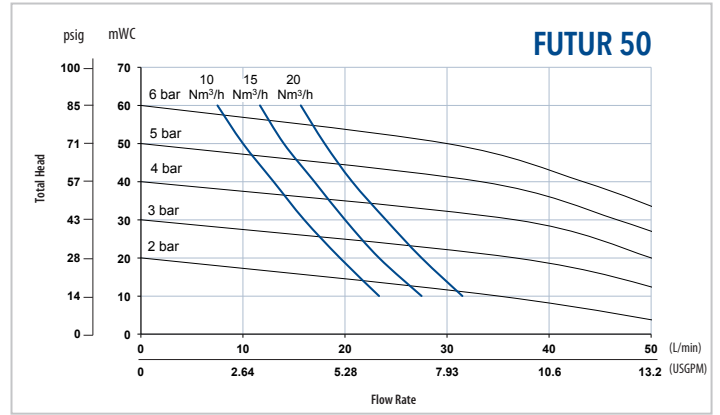
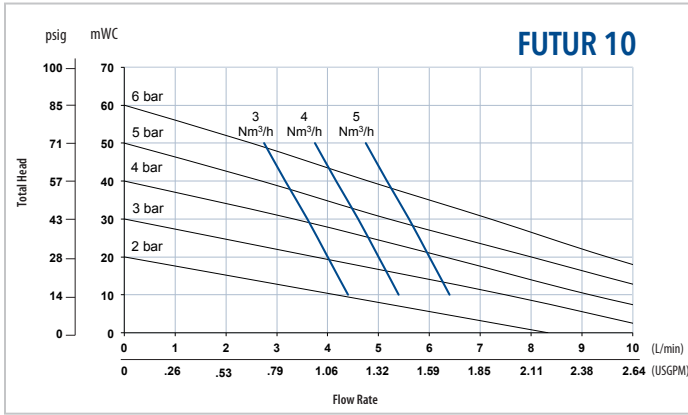

ALMATEC®

PSG Germany GmbH
Hochstraße 150-152
47228 Duisburg, Germany
P: +49 (2065) 89205-0
info@almatec.de
almatec.de



Where Innovation Flows

ALM-10100-C-05

Authorized PSG® Partner:

Copyright 2021 PSG®, a Dover company