



WE'RE ALL ABOUT EXPERIENCE

allpumps.com.au



PISTON PUMPS

2-BALL PUMP MODELS

2-Ball piston pumps are designed for uniform, consistent fluid delivery

For over 85 years, the ARO® Fluid Products business of Ingersoll Rand® has developed partnerships with more than 200 original equipment manufacturers and distributors, enabling us to better focus on the unique pumping needs of many industries. It is a strategic merger of our partners' application expertise, along with our decades-long legacy of designing and building outstanding piston pumps.

Piston pumps are the heartbeat that keeps material flowing through your most vital systems. When a steady stream is essential to your operation, it's important to trust products that can handle the pressure—that's where ARO® comes in.

ARO® offers a versatile range of piston pump packages capable of meeting the specific needs of your specific application. Available in multiple configurations with a broad selection of pressure ratios and displacement rates, our pumps can help unlock superior performance and increase production across a number a unique applications.

Unmatched application expertise in:

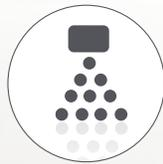

Finishing



Coatings



Sealants and Adhesives



Bulk material transfer and circulation



High-pressure cleaning



Lubrication



Simply better pumps

ARO® LOWER PUMP END TECHNOLOGY

Whether your application requires a 2-ball, 4-ball, or chop-check piston pump, with ARO® you get a pump that's better engineered, from the inside out. We offer design features and performance enhancements that ensure your pump is as durable and dependable as possible — maximizing output and minimizing downtime for a long time to come.

Pump selection made simple

With an ARO® piston pump, you can be assured of getting reliable equipment with the least amount of effort, calculation, or hassle on your part. There are basically four factors to take into consideration when selecting the right configuration for your application:

► Type of fluid ► Viscosity or thickness ► Required flow rate ► Required output pressure

Pump selection at a glance

Knowing fluid viscosity and flow rates makes it easier to choose the right pump for your application. Not sure what size air motor or piston pump you need? No problem. You can find out by calling ARO® Technical Support and working directly with our expert pump consultants, or by visiting our website to access specific pump performance data. Either way, you'll be sure to get a motor and pump package that operates efficiently, reliably, and safely.

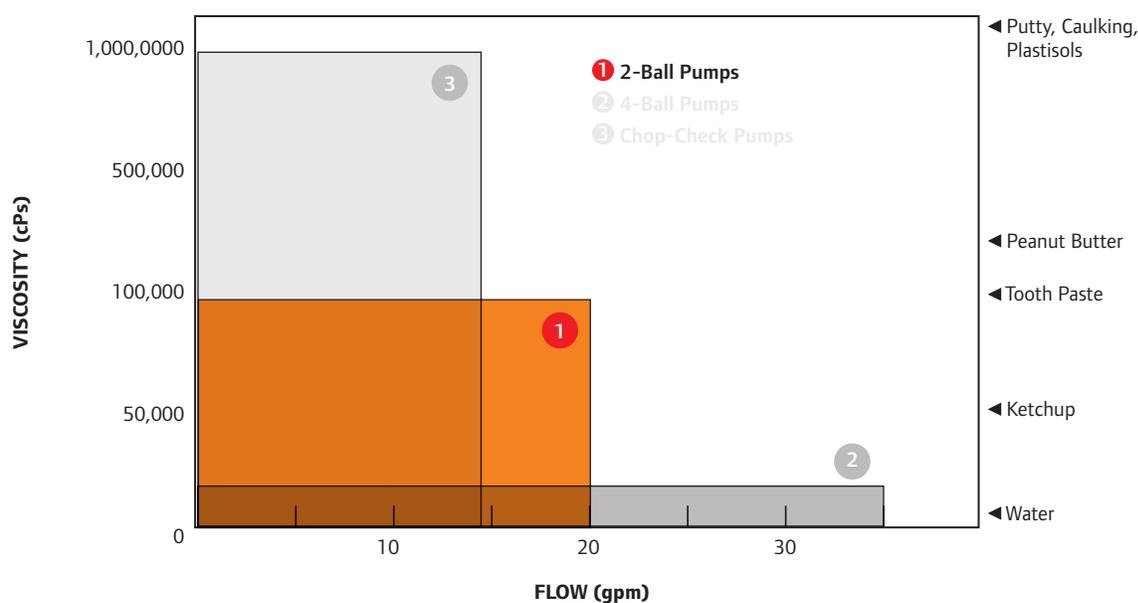

Best-in-class output

- Our 6" stroke delivers best-in-class displacement per cycle, delivering better flow rate, better output, and less fatigue on parts.

Easy serviceability

- Plungers and packings are easily accessible, minimizing downtime.
- Pump packings on the lower pumps are adjustable, featuring a wave spring and guide arrangement.
- Parts are available in convenient service kits so you have the right parts at the right time.

Superior performance with abrasive fluids

- Plunger rods and cylinder tubes feature a ceramic coating, extending service life up to twice as long. Available on 2-ball. Standard on 4-ball.
- Available in affordable **high-grade stainless-steel** construction.
- Electro-polished and passivated for material compatibility and corrosion-free operation.
- **Eight packing options** are available, including ultra-high molecular weight polyethylene (UHMW-PE), for even better material compatibility and excellent abrasion resistance.
- **Chrome-plated stainless steel plungers** for superior resistance to rust and corrosion.

Simply Versatile

2-ball pumps are among the most versatile in the ARO® line. They are capable of handling applications from simple transfer to the extrusion of low- to medium- viscosity materials up to 100,000 centipoise (cPs) with fluid delivery up to 18.1 gpm (68.6 L/min).

Applications advantages of 2-balls:



Spray: 2-ball pumps deliver the constant flow rate and pressure needed for consistent and efficient coatings applications



Transfer & Supply: Depending on the model, some 2-ball pumps can achieve flow rates up to 18.1 gpm, providing dependable results



Extrusion: 2-ball pumps generate pressure to handle extrusion of low-to medium-viscosity



Lubrication: ARO® 2-balls pumps provide the flow and pressure required for moving light oils and grease lubricants



High Pressure Cleaning: ARO® Wash Pump Packages are portable and offer the the right option for industrial cleaning applications

Materials advantages of 2-balls:

- **Shear sensitive materials:** ARO® 2-ball pumps minimize friction points to prevent fluid shear, when compared to other similar pumping technologies
- **Abrasive and high solid materials:** ARO® 2-ball pump minimize friction points and allow smooth passages to maintain fluid consistency
- Optional ceramic coating provides an even stronger defense against highly abrasive fluids like paint and glass-filled sealer

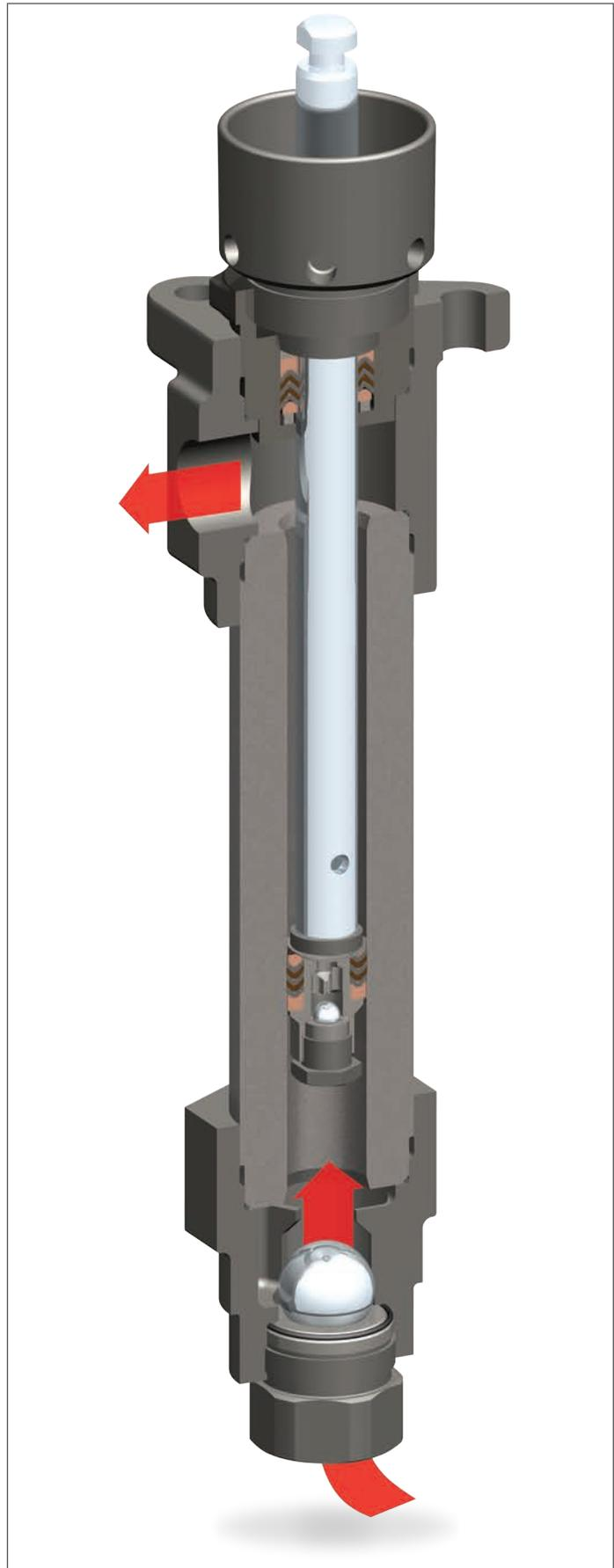

Selection Chart



See Page

1:1		6.0 gal/min 22.7 l/min	Carbon Steel	8
2:1		2.0 gal/min 7.5 l/min	Carbon Steel	9
2:1		4.26 gal/min 16.1 l/min	Stainless Steel	10
2:1		2.15 gal/min 8.14 l/min	Carbon Steel or Stainless Steel	11
4:1		2.11 gal/min 8 l/min	Carbon Steel or Stainless Steel	12, 13
4:1		4.26 gal/min 16.1 l/min	Stainless Steel	14
9:1		2.8 gal/min 10.5 l/min	Carbon Steel	15
9:1		2.9 gal/min 10.8 l/min	Stainless Steel	17
10:1		15.6 gal/min 58.9 l/min	Stainless Steel	19
11:1		3.7 gal/min 14 l/min	Stainless Steel	20
15:1		15.5 gal/min 58.7 l/min	Stainless Steel	22
18:1		0.60 gal/min 2.3 l/min	Stainless Steel	23
22:1		1.9 gal/min 7.3 l/min	Stainless Steel	24
23:1		3.8 gal/min 14.3 l/min	Stainless Steel	25
23:1		15.5 gal/min 58.7 l/min	Stainless Steel	27
23:1		15.5 gal/min 58.7 l/min	Stainless Steel-UV/EB	29
28:1		0.38 gal/min 1.4 l/min	Stainless Steel	30
28:1		5.38 gal/min 20.4 l/min	Stainless Steel	31
30:1		1.3 gal/min 4.9 l/min	Stainless Steel	32
40:1		3.7 gal/min 14 l/min	Stainless Steel	34
45:1		1.9 gal/min 7.3 l/min	Stainless Steel	35
45:1		5.38 gal/min 20.4 l/min	Stainless Steel	37
60:1		1.4 gal/min 5.4 l/min	Stainless Steel	38
65:1		5.38 gal/min 20.4 l/min	Stainless Steel	40

Viscosity Guide

Flow (gpm)	Maximum Delivery Rate gpm (L/min)	Ratio	Fluid Pressure Range psi (bar)	Pump Model Number	Material of Construction	Lower End Type	500 cPs	1,000 cPs
0-2	0.76 (2.8)	28:1	0 - 4200 (0 - 289.7)	NM2328A-11-X11	Stainless Steel	2-Ball	Siphon	
	1.2 (4.5)	18:1	540 - 2700 (37.2 - 186.2)	NM2318B-13-C43	Stainless Steel	2-Ball	Siphon	
	1.3 (4.9)	30:1	900 - 4629 (62.1 - 319.2)	AF0430G11XXXX	Stainless Steel	2-Ball	Siphon	
	1.4 (5.4)	60:1	1800 - 6172 (124.1 - 425.5)	AF0660G11XXXX	Stainless Steel	2-Ball	Siphon	
	1.6 (6.1)	3.3:1 Hyd	165 - 3960 (11.4 - 273.1)	650944-C43-B	Stainless Steel	2-Ball	Siphon	
	1.9 (7.2)	22:1	660 - 3412 (45.5 - 235.3)	AF0422G11XXXX	Stainless Steel	2-Ball	Siphon	
	1.9 (7.2)	45:1	1350 - 5459 (93.1 - 376.4)	AF0645G11XXXX	Stainless Steel	2-Ball	Siphon	
2-4	2.9 (11)	9:1	0 - 1350 (0 - 93.1)	AF0409C51XXXX	Stainless Steel	2-Ball		
	2.8 (10.6)	9:1	0 - 1350 (0 - 93.1)	AF0409AX1XX24-02	Carbon Steel	2-Ball		
	2.9 (11)	9:1	0 - 1350 (0 - 93.1)	AF0409C11XXXX	Stainless Steel	2-Ball	Siphon	
	3.1 (11.9)	1.7:1 Hyd	85 - 2054 (5.9 - 140.7)	650943-XXX-B	Stainless Steel	2-Ball	Siphon	
	3.7 (14)	11:1	330 - 1747 (22.8 - 120.5)	AF0411G11XXXX	Stainless Steel	2-Ball	Siphon	
	3.7 (14)	23:1	690 - 3495 (47.6 - 241)	AF0623G11XXXX	Stainless Steel	2-Ball	Siphon	
4-10	3.7 (14)	40:1	1200 - 4697 (82.7 - 323.9)	AF0840G11XXXX	Stainless Steel	2-Ball	Siphon	
	4.1 (15.5)	2:1	0 - 300 (0 - 20.7)	650110-C	Carbon Steel	2-Ball	Siphon	
	4.2 (15.9)	4:1	60 - 795 (4.1 - 54.8)	NM2304B-11-XXX	Stainless Steel	2-Ball	Siphon	
	4.2 (15.9)	4:1	60 - 795 (4.1 - 54.8)	NM2304B-41-XXX	Stainless Steel	2-Ball	Siphon	
	4.2 (15.9)	4:1	0 - 600 (0 - 41.4)	650313-X, 650314-X	Stainless Steel	2-Ball	Siphon	
	4.2 (15.9)	2:1	60 - 343 (4.1 - 23.6)	650311-X, 650312-X	Stainless Steel	2-Ball	Siphon	
	4.3 (16.3)	2:1	0 - 351 (0 - 24.2)	NM2202A-11-XXX	Carbon Steel	2-Ball	Siphon	
	4.3 (16.3)	2:1	0 - 351 (0 - 24.2)	NM2202A-41-XXX	Carbon Steel	2-Ball	Siphon	
	4.3 (16.3)	2:1	0 - 351 (0 - 24.2)	NM2202B-11-XXX	Stainless Steel	2-Ball	Siphon	
	4.3 (16.3)	2:1	0 - 351 (0 - 24.2)	NM2202B-41-XXX	Stainless Steel	2-Ball	Siphon	
	4.2 (15.9)	4:1	60 - 795 (4.1 - 54.8)	NM2304A-11-XXX	Carbon Steel	2-Ball	Siphon	
	4.2 (15.9)	4:1	60 - 795 (4.1 - 54.8)	NM2304A-41-XXX	Carbon Steel	2-Ball	Siphon	
	5.4 (20.4)	28:1	840 - 3360 (57.9 - 231.7)	AF0828G11XXXX	Stainless Steel	2-Ball	Siphon	
	5.4 (20.4)	45:1	1350 - 4050 (93.1 - 279.2)	AF1045G11XXXX	Stainless Steel	2-Ball	Siphon	
5.4 (20.4)	65:1	1950 - 5850 (134.5 - 403.3)	AF1265G11XXXX	Stainless Steel	2-Ball	Siphon		
10-20	6 (22.7)	1:1	0 - 150 (0 - 10.3)	612041-X	Carbon Steel	2-Ball	Siphon	
	12.9 (48.8)	0.8:1 Hyd	40 - 1600 (2.8 - 110.3)	650940-XXX-B	Stainless Steel	2-Ball	Siphon	
	15.5 (58.7)	10:1	300 - 1200 (20.7 - 82.7)	AF0810C11XXXX	Stainless Steel	2-Ball	Siphon	
	15.5 (58.7)	10:1	300 - 1200 (20.7 - 82.7)	AF0810F11XXXX	Stainless Steel	2-Ball	Siphon	
	15.5 (58.7)	15:1	450 - 1350 (31 - 93.1)	AF1015C11XXXX	Stainless Steel	2-Ball	Siphon	
	15.5 (58.7)	15:1	450 - 1350 (31 - 93.1)	AF1015FX, AF1015JX	Stainless Steel	2-Ball	Siphon	
	15.5 (58.7)	23:1	690 - 2070 (47.6 - 142.7)	AF1223C11XXXX	Stainless Steel	2-Ball	Siphon	
	15.5 (58.7)	23:1	690 - 2070 (47.6 - 142.7)	AF1223F11XXXX	Stainless Steel	2-Ball	Siphon	
15.5 (58.7)	23:1	690 - 2070 (47.6 - 142.7)	AF1223C51XXXX	Stainless Steel	2-Ball	Siphon		

Note:

Maximum pump outlet pressure in specification tables are the theoretical maximum pressures that can be obtained by the pumps. Pressure and flow in the pump performance curves (following pages) are actual test data based on the conditions described.

1:1
2"

61204X-X Series Pumps

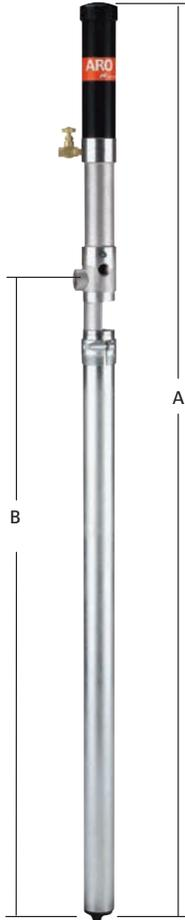

Materials: Oils, Light fluids

Pump Specifications

Ratio	1:1
Stroke in (mm)	6 (15.2)
Material Inlet	Immersed
Material Outlet	3/4" NPT(F)
Air Inlet (female)	1/4" NPT(F)
Air Inlet Pressure Range psi (bar)	0-150 (0-10.3)
Fluid Pressure Range psi (bar)	0-150 (0-10.3)
Max Cycles/Minute	75
Displacement/Cycle cu in (cm3)	18.8 (308)
Volume/Cycle oz (ml)	10.4 (307.7)
Cycles/gal (L)	12.3 (3.3)
Flow @ 75 Cycles gpm (L/min)	6.0 (22.7)
Noise Level @ 60 psi dBA	77.8
Weight* lb (kg)	612041-1, 612401-3 13 (5.9) 612402-1 14 (6.4)

*Estimated weight. Contact Technical Support for exact weight.

DIMENSIONS	A in (mm)	B in (mm)
612041-X	54 (1371.6)	34.625 (879.5)
612042-X	64.25 (1631.9)	44.875 (1139.8)

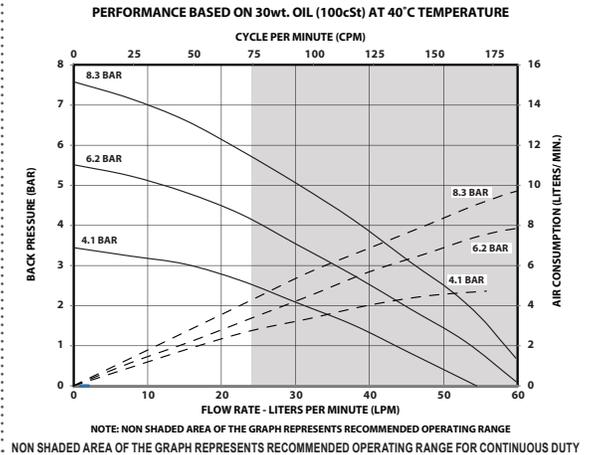
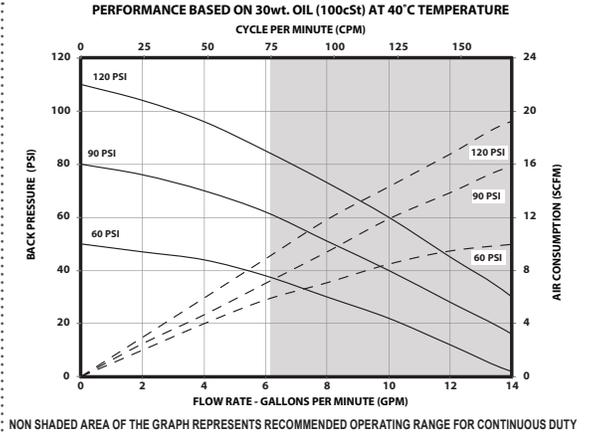

Pump Model	Container Suitability	Type	Plunger Material	Upper Packings	Lower Packings	Pump Service Kit
Lower Pump Material - Carbon Steel						
612041-1	55 Gallon (208.2 L)	Wall mount or drum	Carbon Steel	Nitrile	Nitrile	637081
612041-3	55 Gallon (208.2 L)	Wall mount or drum	Carbon Steel	PTFE	PTFE	637083
612042-1	275 Gallon (1041 L)	Wall mount or drum	Carbon Steel	Nitrile	Nitrile	637081

*Lower pump repair kit

Recommended Accessories

				
61879 Muffler	635040 ARO-Stop Valve	61113 Wall Mount Bracket	C38121-600 Air FRL	637084 Air Motor Service Kit

2:1
2"

650110-X Series Pumps

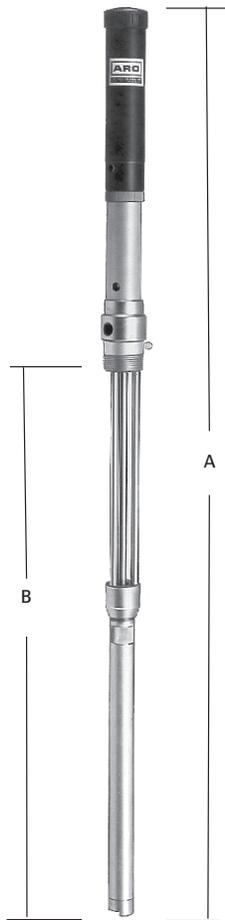

Materials: Oils, Light fluids

Pump Specifications

Ratio	2:1
Stroke in (mm)	6 (152)
Material Inlet	Immersed
Material Outlet	650110-C 1/2"
	650110-1C 3/4" NPT(F)
Air Inlet (female)	1/4" NPT(F)
Air Inlet Pressure Range psi (bar)	0-150 (0-10.3)
Fluid Pressure Range psi (bar)	0-300 (0-20.7)
Max Cycles/Minute	120
Displacement/Cycle cu in (cm ³)	8.0 (131)
Volume/Cycle oz (ml)	4.4 (131)
Cycles/gal (L)	28.9 (7.6)
Flow @ 60 Cycles gpm (L/min)	2.0 (7.5)
Noise Level @ 60 psi dBA	81
Weight* lb (kg)	12 (5.4)

*Estimated weight. Contact Technical Support for exact weight.

DIMENSIONS	A	B
	in (mm)	in (mm)
650110-X	53.09(1349)	33.81(859)

PERFORMANCE BASED ON 30wt. OIL (100 cSt) AT 40° C TEMPERATURE

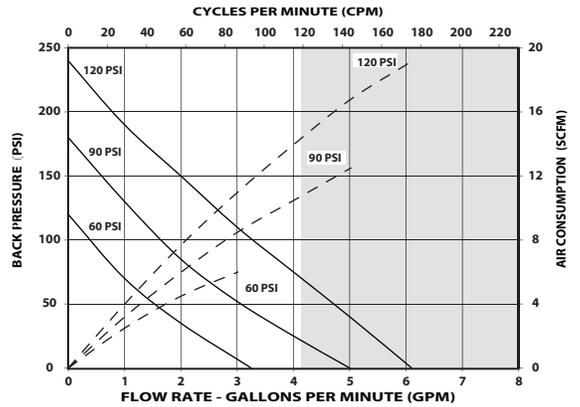

NON SHADED AREA OF THE GRAPH REPRESENTS RECOMMENDED OPERATING RANGE FOR CONTINUOUS DUTY

PERFORMANCE BASED ON 30wt. OIL (100 cSt) AT 40° C TEMPERATURE

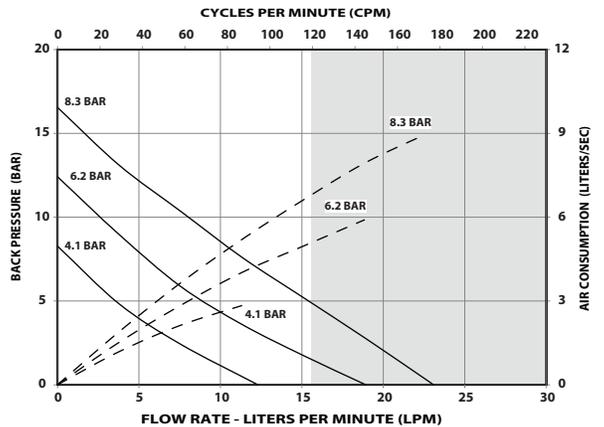

NON SHADED AREA OF THE GRAPH REPRESENTS RECOMMENDED OPERATING RANGE FOR CONTINUOUS DUTY

Pump Model	Container Suitable	Lower Pump Material	Plunger Material	Upper Packings	Lower Packings	Pump Service Kit*
Lower Pump Material - Carbon Steel						
650110-C	55 Gallon (208.2 L)	Carbon Steel	Carbon Steel	UHMW-PE	UHMW-PE	637028
650110-1C	55 Gallon (208.2 L)	Carbon Steel	Carbon Steel	PTFE	PTFE	637029

*Lower pump repair kit

Recommended Accessories



61879 Muffler



635040 ARO-Stop Valve



61113 Wall Mount Bracket



C28121-600 Air FRL



66098 Air Motor Service Kit

2:1
2"

N Series

65031X-X Series Pumps

WITH CYCLE COUNTER



Materials: Oils, Light fluids

Pump Specifications

Ratio	2:1
Stroke in (cm)	3 (76)
Material Inlet	1 -1/4" NPS
Material Outlet	3/4" NPT(F)
Air Inlet (female)	1/4" NPT(F)
Air Inlet Pressure Range psi (bar)	30-150 (2.1-10.3)
Fluid Pressure Range psi (bar)	60-343 (4.1-23.6)
Max Cycles/Minute	120
Max Working Flow Rate gpm (lpm)	4.26 (16.12)
Displacement/Cycle cu in (cm3)	8.2 (134.3)
Volume / Cycle oz (ml)	4.5 (133)
Cycles/gal (L)	28 (7.4)
Noise Level dBA	80
Weight lb (kg)	650311-X 23 (10.4) 650312-X 41 (18.6)

DIMENSIONS	A in (mm)	B in (mm)
650311-X	28.093 (714)	9.875(251)
650312-X	51.437 (1306)	33.219 (846)

PERFORMANCE BASED ON 30wt. OIL (100 cSt) AT 40° C TEMPERATURE
CYCLES PER MINUTE (CPM)

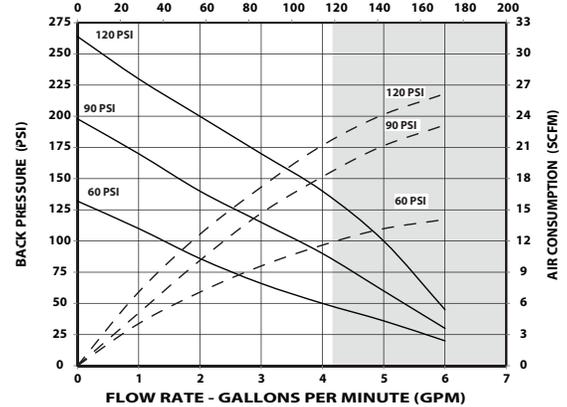

NON SHADED AREA OF THE GRAPH REPRESENTS RECOMMENDED OPERATING RANGE FOR CONTINUOUS DUTY

PERFORMANCE BASED ON 30wt. OIL (100 cSt) AT 40° C TEMPERATURE
CYCLES PER MINUTE (CPM)

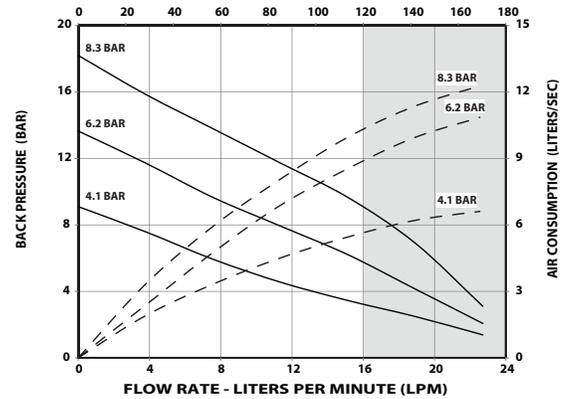

NON SHADED AREA OF THE GRAPH REPRESENTS RECOMMENDED OPERATING RANGE FOR CONTINUOUS DUTY

Pump Model	Lower Pump Material	Container Suitability	Plunger Material	Upper Packings	Lower Packings	Lower Pump Model	Lower Pump Mounting Footprint	Pump Service Kit
650311	Stainless Steel	Stub	Stainless Steel	PTFE	PTFE	1875C11SS22	C	K1875C11SS00
650311-4	Stainless Steel	Stub	Stainless Steel	UHMW-PE	UHMW-PE	1875C11FF22	C	K1875C11FF00
650311-5	Stainless Steel	Stub	Ceramic Coated Stainless Steel	PTFE	PTFE	1875C11SS29	C	K1875C11FF00
650311-6	Stainless Steel	Stub	Ceramic Coated Stainless Steel	UHMW-PE	UHMW-PE	1875C11FF29	C	K1875C11FF00
650311-7	Stainless Steel	Stub	Ceramic Coated Stainless Steel	Viton	UHMW-PE	1875C11VF29	C	K1875C11VF00
650311-8	Stainless Steel	Stub	Stainless Steel	Viton	PTFE	1875C11VS22	C	K1875C11VS00
650311-9	Stainless Steel	Stub	Stainless Steel	Viton	UHMW-PE	1875C11VF2E	C	K1875C11VF00
650312	Stainless Steel	55 Gallon	Stainless Steel	PTFE	PTFE	1875C51SS22	C	K1875C11SS00
650312-4	Stainless Steel	55 Gallon	Stainless Steel	UHMW-PE	UHMW-PE	1875C51FF22	C	K1875C11FF00

Recommended Accessories



66073-1
Air Line Connection Kit



635040
ARO-Stop Valve



61113
Wall Mount Bracket

2:1
2"

N
Series

NM2202X-X1-X31 Series Pumps

NITROGEN BLANKET PORT



Optional Nitrogen Blanket Port
Capable of introducing a nitrogen blanket for isocyanate foam applications, to prevent material from curing in the pump and container.

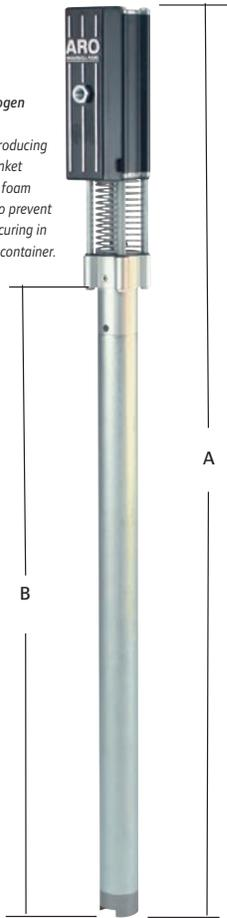

Materials: Oils, Light fluids

Pump Specifications

Ratio	2:1
Stroke in (cm)	3 (7.6)
Material Inlet	1-1/2" NPT(F)
Material Outlet	3/4" NPT(F)
Air Inlet (female)	1/4" NPT(F)
Air Inlet Pressure Range psi (bar)	0-150 (0-10.3)
Fluid Pressure Range psi (bar)	0-351 (0-24.2)
Max Cycles/Minute	120
Displacement/Cycle cu in (cm ³)	8.28 (136)
Cycles/gal (L)	27.9 (7.3)
Flow @ 60 Cycles gpm (L/min)	2.15 (8.14)
Noise Level @ 100 psi dBA	80
Weight* lb (kg)	NM2202A-11-X31 17.5 (7.9) NM2202A-41-X31 19.6 (8.9) NM2202B-11-X31 17.2 (7.8) NM2202B-41-X31 22.5 (10.2)

*Estimated weight. Contact Technical Support for exact weight.

DIMENSIONS	A in (mm)	B in (mm)
NM2202A-11-X31	34.17(868)	20.03(509)
NM2202A-41-X31	47.83 (1215)	33.70(856)
NM2202B-11-X31	33.85 (860)	19.84(504)
NM2202B-41-X31	47.71(1212)	33.70(856)

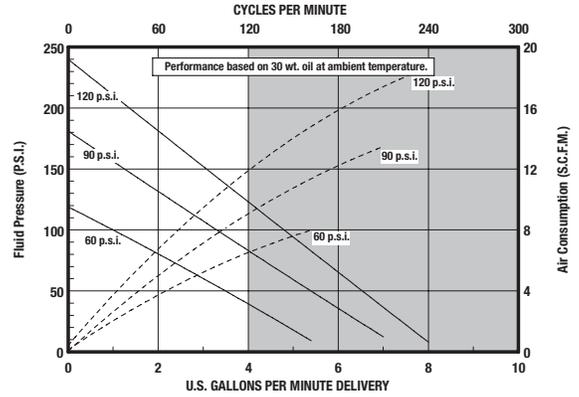

NON SHADED AREA OF THE GRAPH REPRESENTS RECOMMENDED OPERATING RANGE FOR CONTINUOUS DUTY

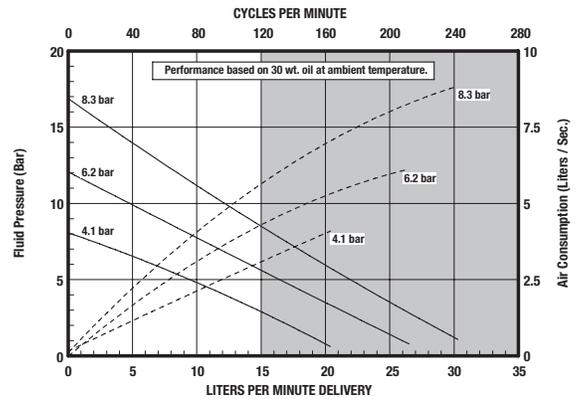

NON SHADED AREA OF THE GRAPH REPRESENTS RECOMMENDED OPERATING RANGE FOR CONTINUOUS DUTY

Pump Model	Container Suitability	Lower Pump Material	Plunger Material	Upper Packings	Lower Packings	Pump Service Kit
Lower Pump Material - Carbon Steel						
NM2202A-11-731	Stub	Carbon Steel	Carbon Steel	PTFE	PTFE	637378-731
NM2202A-11-C31	Stub	Carbon Steel	Carbon Steel	UHMW-PE	UHMW-PE	637378-C31
NM2202A-11-J31	Stub	Carbon Steel	Carbon Steel	Polyurethane	UHMW-PE	637378-J31
NM2202A-41-731	55 Gallon	Carbon Steel	Carbon Steel	PTFE	PTFE	637378-731
NM2202A-41-C31	55 Gallon	Carbon Steel	Carbon Steel	UHMW-PE	UHMW-PE	637378-C31
NM2202A-41-J31	55 Gallon	Carbon Steel	Carbon Steel	Polyurethane	UHMW-PE	637378-J31
Lower Pump Material - Stainless Steel						
NM2202B-11-731	Stub	Stainless Steel	Stainless Steel	PTFE	PTFE	637379-731
NM2202B-11-C31	Stub	Stainless Steel	Stainless Steel	UHMW-PE	UHMW-PE	637379-C31
NM2202B-11-J31	Stub	Stainless Steel	Stainless Steel	Polyurethane	UHMW-PE	637379-J31
NM2202B-41-731	55 Gallon	Stainless Steel	Stainless Steel	PTFE	PTFE	637379-731
NM2202B-41-C31	55 Gallon	Stainless Steel	Stainless Steel	UHMW-PE	UHMW-PE	637379-C31
NM2202B-41-J31	55 Gallon	Stainless Steel	Stainless Steel	Polyurethane	UHMW-PE	637379-J31

*Lower pump repair kit

Recommended Accessories



66073-1
Air Line Connection Kit



635040
ARO-Stop Valve



61113
Wall Mount Bracket



637377
Air Motor Service Kit

67088-4
Sealed Bung Assembly

4:1
3"

N Series

NM2304X-X1-X11 Series Pumps

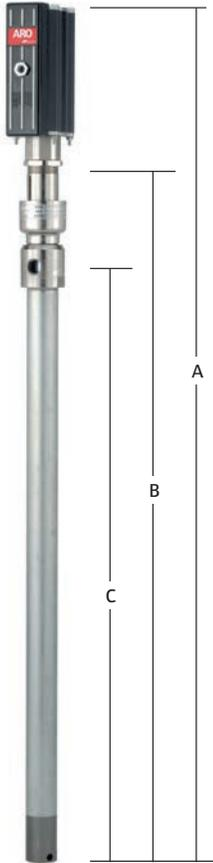

Materials: Oils, Light fluids

Pump Specifications

Ratio	4:1
Stroke in (cm)	3 (76)
Material Outlet	3/4" NPT(F)
Air Inlet (female)	1/4" NPT(F)
Air Inlet Pressure Range psi (bar)	30-150 (2.1-10.3)
Fluid Pressure Range psi (bar)	60-795 (4.1-54.8)
Max Cycles/Minute	120
Displacement/Cycle cu in (cm3)	8.2 (134.3)
Cycles/gal (L)	28 (7.4)
Flow @ 1200 Cycles gpm (L/min)	4.26 (16.121)
Noise Level @ 100 psi dBA	85

See stainless steel models on following page.

PERFORMANCE BASED ON 30wt. OIL (100 cSt) AT 40° C TEMPERATURE
CYCLES PER MINUTE (CPM)

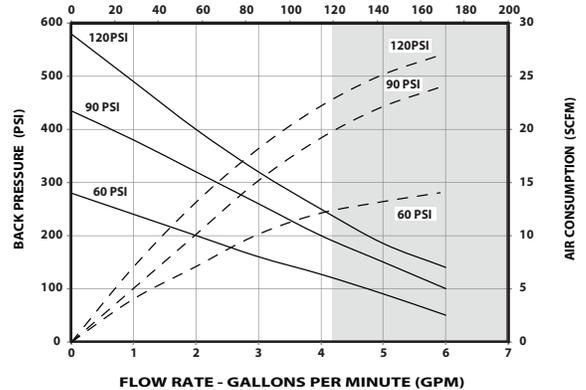

NON SHADED AREA OF THE GRAPH REPRESENTS RECOMMENDED OPERATING RANGE FOR CONTINUOUS DUTY

PERFORMANCE BASED ON 30wt. OIL (100 cSt) AT 40° C TEMPERATURE
CYCLES PER MINUTE (CPM)

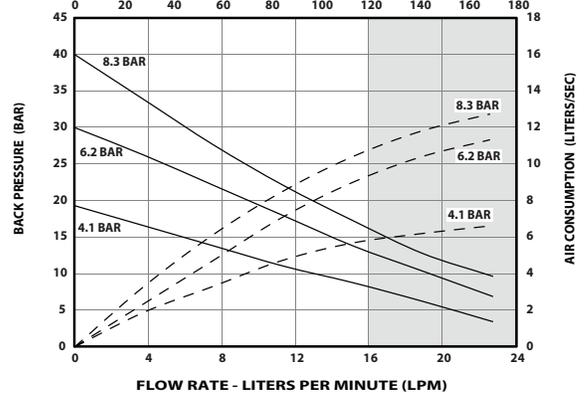

NON SHADED AREA OF THE GRAPH REPRESENTS RECOMMENDED OPERATING RANGE FOR CONTINUOUS DUTY

Pump Model	Container Suitability	Lower Pump Material	Plunger Material	Upper Packings	Lower Packings	Material Inlet	Weight lb (kg)	Pump Service Kit
Lower Pump Material - Carbon Steel								
NM2304A-11-311	Stub	Carbon Steel	Carbon Steel	PTFE	PTFE	1.25" NPT(F)	32 (14.5)	637176
NM2304A-11-511	Stub	Carbon Steel	Carbon Steel	PTFE/Leather staggered	PTFE	1.25" NPT(F)	32 (14.5)	637176
NM2304A-11-C11	Stub	Carbon Steel	Carbon Steel	UHMW-PE	UHMW-PE	1.25" NPT(F)	32 (14.5)	637228
NM2304A-41-311	55 Gallon	Carbon Steel	Carbon Steel	PTFE	PTFE	Immersed	46 (20.9)	637176
NM2304A-41-511	55 Gallon	Carbon Steel	Carbon Steel	PTFE/Leather staggered	PTFE	Immersed	46 (20.9)	637176
NM2304A-41-C11	55 Gallon	Carbon Steel	Carbon Steel	UHMW-PE	UHMW-PE	Immersed	46 (20.9)	637228
NM2304A-81-311	Stub	Carbon Steel	Carbon Steel	PTFE	PTFE	1.25" NPT(F)	31.4 (14.3)	637176
NM2304A-91-311	55 Gallon	Carbon Steel	Carbon Steel	PTFE	PTFE	Immersed	45.4 (20.6)	637176
NM2304A-A1-311	Stub	Carbon Steel	Carbon Steel	PTFE	PTFE	Immersed	31 (14.1)	637176
NM2304A-B1-311	Stub	Carbon Steel	Carbon Steel	PTFE	PTFE	1.25" NPT(F)	32 (14.5)	637176

*Lower pump repair kit

Model	A in (mm)	B in (mm)	C in (mm)
NM2304A-11-X11	30.25 (768.5)	11.75 (297.7)	13.187 (334.2)
NM2304A-41-X11	55.625 (1413.0)	37.125 (942.2)	38.562 (978.7)
NM2304B-11-X11	28.125 (714.4)	9.718 (246.8)	11.096 (281.8)
NM2304B-41-X11	51.656 (1312.1)	33.25 (844.6)	34-5/8 (879.6)

Recommended Accessories



P29122-600
Piggyback F/R



635040
ARO-Stop Valve



61113
Wall Mount Bracket



66333-B
Wet Sol



637316
Air Motor Service Kit

4:1
3"

N Series

NM2304X-X1-X11 Series Pumps

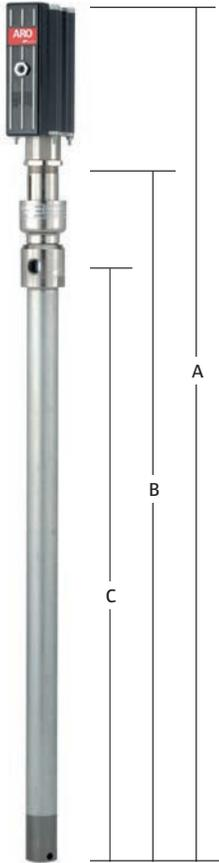

Materials: Oils, Chemicals

Pump Specifications

Ratio	4:1
Stroke in (cm)	3 (76)
Material Outlet	3/4" NPT(F)
Air Inlet (female)	1/4" NPT(F)
Air Inlet Pressure Range psi (bar)	30-150 (2.1-10.3)
Fluid Pressure Range psi (bar)	60-795 (4.1-54.8)
Max Cycles/Minute	120
Displacement/Cycle cu in (cm3)	8.2 (134.3)
Cycles/gal (L)	28 (7.4)
Flow @ 60 Cycles gpm (L/min)	2.1 (8.0)
Noise Level @ 100 psi dBA	85

PERFORMANCE BASED ON 30wt. OIL (100 cSt) AT 40° C TEMPERATURE
CYCLES PER MINUTE (CPM)

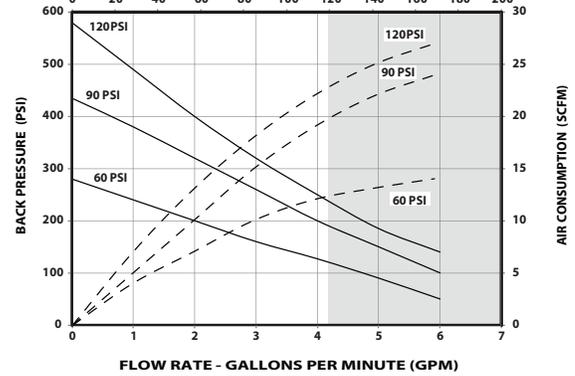

PERFORMANCE BASED ON 30wt. OIL (100 cSt) AT 40° C TEMPERATURE
CYCLES PER MINUTE (CPM)

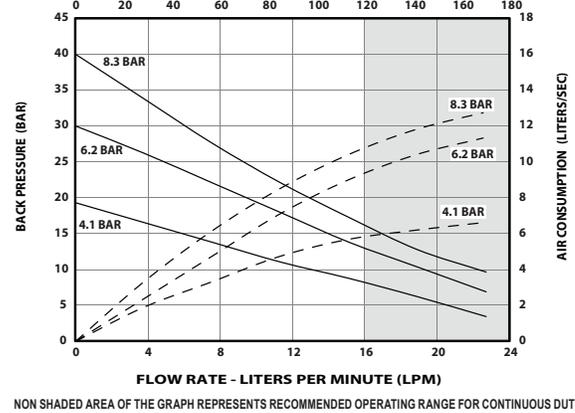

Pump Model	Container Suitability	Lower Pump Material	Plunger Material	Upper Packings	Lower Packings	Material Inlet	Weight lb (kg)	Pump Service Kit*
Lower Pump Material - Stainless Steel								
NM2304B-11-311	Stub	316 Stainless Steel	316 Stainless Steel	PTFE	PTFE	1.25" NPT(F)	32 (14.5)	637010
NM2304B-11-31B	Stub	316 Stainless Steel	Ceramic Coated Stainless Steel	PTFE	PTFE	1.25" NPT(F)	32 (14.5)	637010
NM2304B-11-C11	Stub	316 Stainless Steel	316 Stainless Steel	UHMW-PE	UHMW-PE	1.25" NPT(F)	32 (14.5)	637010-4
NM2304B-11-C1B	Stub	316 Stainless Steel	Ceramic Coated Stainless Steel	UHMW-PE	UHMW-PE	1.25" NPT(F)	32 (14.5)	637010-4
NM2304B-11-W11	Stub	316 Stainless Steel	316 Stainless Steel	Viton	PTFE	1.25" NPT(F)	32 (14.5)	637010-6
NM2304B-41-311	55 Gallon	316 Stainless Steel	316 Stainless Steel	PTFE	PTFE	1.25" NPT(F)	46 (20.9)	637010
NM2304B-41-C11	55 Gallon	316 Stainless Steel	316 Stainless Steel	UHMW-PE	UHMW-PE	1.25" NPT(F)	46 (20.9)	637010-4

*Lower pump repair kit

Model	A in (mm)	B in (mm)	C in (mm)
NM2304A-11-X11	30.25 (768.5)	11.75 (297.7)	13.187 (334.2)
NM2304A-41-X11	55.625 (1413.0)	37.125 (942.2)	38.562 (978.7)
NM2304B-11-X11	28.125 (714.4)	9.718 (246.8)	11.096 (281.8)
NM2304B-41-X11	51.656 (1312.1)	33.25 (844.6)	34-5/8 (879.6)

Recommended Accessories



P29122-600 Piggyback F/R



635040 ARO-Stop Valve



61113 Wall Mount Bracket



66333-B Wet Sol



637316 Air Motor Service Kit

4:1

3"

65031X-X Series Pumps

WITH CYCLE COUNTER



Materials: Oils, Light fluids

Pump Specifications

Ratio	4:1
Stroke in (cm)	3 (76)
Material Inlet	1-1/4" NPS
Material Outlet	3/4" NPT(F)
Air Inlet (female)	1/4" NPT(F)
Air Inlet Pressure Range psi (bar)	30-150 (2.1-10.3)
Fluid Pressure Range psi (bar)	60-795 (4.1-54.8)
Max Cycles/Minute	120
Max Working Flow Rate gpm (lpm)	4.26 (16.12)
Displacement/Cycle cu in (cm3)	8.2 (134.3)
Volume / Cycle oz (ml)	4.5 (133)
Cycles/gal (L)	28 (7.4)
Noise Level @ 100 psi dBA	80
Weight lb (kg)	650313-X 23 (10.4) 650314-X 41 (18.6)

DIMENSIONS	A in (mm)	B in (mm)
650313-X	28.093 (714)	9.875(251)
650314-X	51.437 (1306)	33.219 (846)

PERFORMANCE BASED ON 30wt. OIL (100 cSt) AT 40° C TEMPERATURE
CYCLES PER MINUTE (CPM)

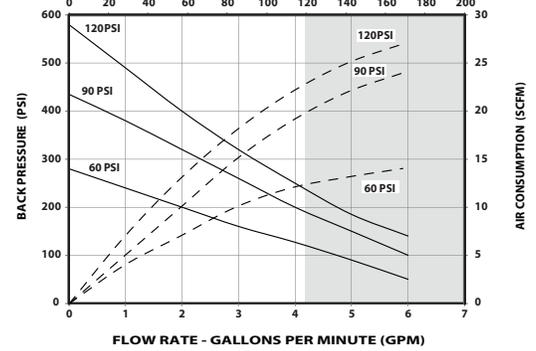

PERFORMANCE BASED ON 30wt. OIL (100 cSt) AT 40° C TEMPERATURE
CYCLES PER MINUTE (CPM)

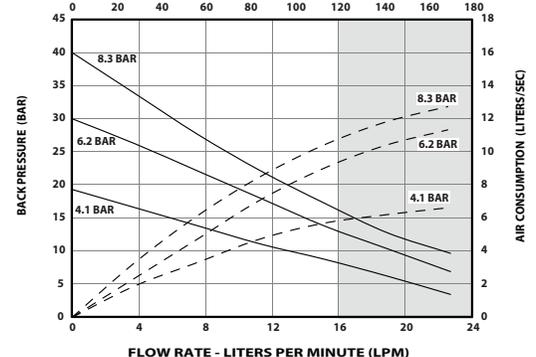

Pump Model	Lower Pump Material	Container Suitability	Plunger Material	Upper Packings	Lower Packings	Lower Pump Model	Lower Pump Mounting Footprint	Pump Service Kit
650313	Stainless Steel	Stub	Stainless Steel	PTFE	PTFE	1875C11SS22	C	K1875C11SS00
650313-4	Stainless Steel	Stub	Stainless Steel	UHMW-PE	UHMW-PE	1875C11FF22	C	K1875C11FF00
650313-5	Stainless Steel	Stub	Ceramic Coated Stainless Steel	PTFE	PTFE	1875C11SS29	C	K1875C11FF00
650313-6	Stainless Steel	Stub	Ceramic Coated Stainless Steel	UHMW-PE	UHMW-PE	1875C11FF29	C	K1875C11FF00
650313-7	Stainless Steel	Stub	Ceramic Coated Stainless Steel	Viton	UHMW-PE	1875C11VF29	C	K1875C11VF00
650313-8	Stainless Steel	Stub	Stainless Steel	Viton	PTFE	1875C11VF22	C	K1875C11VF00
650313-9	Stainless Steel	Stub	Stainless Steel	Viton	UHMW-PE	1875C11VF2E	C	K1875C11VF00
650314	Stainless Steel	55 Gallon	Stainless Steel	PTFE	PTFE	1875C51SS22	C	K1875C11SS00
650314-4	Stainless Steel	55 Gallon	Stainless Steel	UHMW-PE	UHMW-PE	1875C51FF22	C	K1875C11FF00

Recommended Accessories



66073-1
Air Line Connection Kit



635040
ARO-Stop Valve



61113
Wall Mount Bracket

9:1
4-1/4"

**AFX
Series**

AF0409 Series Pumps

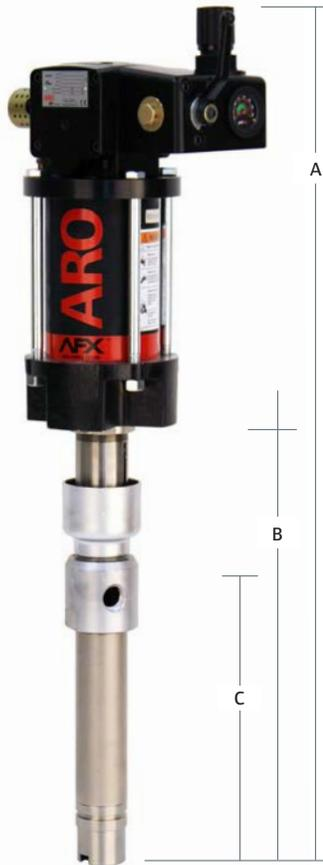

(Model shown w/ball valve regulator)

Materials: Oils, Paint, Coatings, Chemicals

Pump Specifications

Ratio	9:1
Stroke (double acting)	4" (10.2 cm)
Material Inlet	See Dimensions
Material Outlet	3/4" NPT(F)
Air Inlet (female)	1/2" NPT(F)
Air Inlet Pressure Range psi (bar)	30 - 150 (2 - 10.3)
Fluid Pressure Range psi (bar)	270 - 1350 (18.6 - 93.1)
Max Cycles/Minute	60
Displacement/Cycle cu in (cm3)	11.0 (180.2)
Cycles/gal (L)	21 (5.5)
Flow @ 60 Cycles gpm (L/min)	2.9 (10.8)
Noise Level @ 60 psi dBA	89.2
Weight* lb (kg)	55 Gallon Unit 49 (22.2) Remote Mount Unit 35 (15.8)

*Estimated weight. Contact Technical Support for exact weight.

DIMENSIONS	
55 Gallon Unit	
A ¹ in (mm)	61.74 (1568.25)
B in (mm)	38.53 (978.71)
Material Inlet	Immersed -
Remote Mount Unit	
A ¹ in (mm)	35.21 (894.33)
B in (mm)	12.00 (304.80)
Material Inlet	1-1/2" NPT -

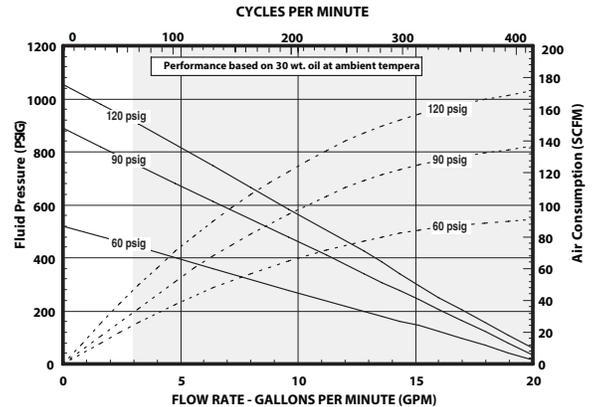

NON SHADED AREA OF THE GRAPH REPRESENTS RECOMMENDED OPERATING RANGE FOR CONTINUOUS DUTY

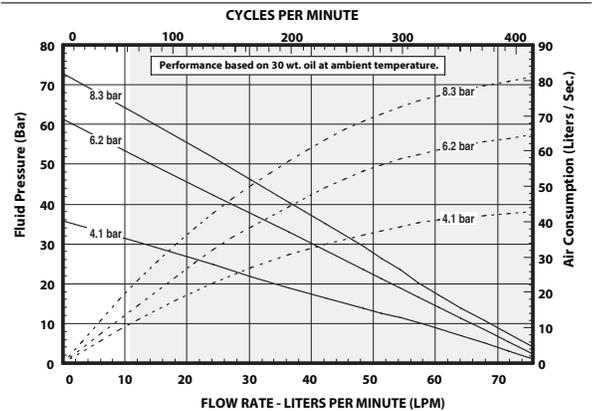

NON SHADED AREA OF THE GRAPH REPRESENTS RECOMMENDED OPERATING RANGE FOR CONTINUOUS DUTY

Pump Model**	Container Suitability	Plunger Material	Upper Packings	Lower Packings	Lower Pump Model	Lower Pump Mounting Footprint	Pump Service Kit
Lower Pump Material - Carbon Steel							
AF0409A81KS24-02	Remote Mounting	Carbon Steel w/ Hard Chrome	Glass Filled PTFE	Virgin PTFE	1875A81KS24	N/A	K1875A11KS24
AF0409A51KS24-02	55 Gallon (400 lbs)	Carbon Steel w/ Hard Chrome	Glass Filled PTFE	Virgin PTFE	1875A51KS24	N/A	K1875A11KS24
AF0409A51FF24-02	55 Gallon (400 lbs)	Carbon Steel w/ Hard Chrome	UHMW-PE	UHMW-PE	1875A51FF24	N/A	K1875A11FF24
AF0409A81US24-02	Remote Mounting	Carbon Steel w/ Hard Chrome	Glass Filled PTFE/Leather (Staggered)	Virgin PTFE	1875A81US24	N/A	K1875A11US24
AF0409A81HF24-02	Remote Mounting	Carbon Steel w/ Hard Chrome	UHMW-PE	UHMW-PE	1875A81HF24	N/A	K1875A11HF24
AF0409A81FF24-02	Remote Mounting	Carbon Steel w/ Hard Chrome	UHMW-PE	UHMW-PE	1875A81FF24	N/A	K1875A11FF24
AF0409A91LL2D	5 Gallon	Carbon Steel	Leather	Leather	1875A91LL2D	C	K1875A19LL2D

**Add "-1" to Model No. or for Models Ending in "-02" change to "-12" for Ball Valve Regulator

Recommended Accessories



67445-1
Muffler Kit



66334-B
Wet-Sol Packing
Lubricant



23644-400
ARO-Stop
Valve



67136
Floor/Follower
Plate Adapter



67442
Ball Valve Regulator



637489
Universal Air Motor
Service Kit

**AFX
Series**

9:1 Ratio Pump Packages



**CLX Series
Cart-Mounted Lift**



Packages						
Model No.	Package Type	Pump Model	Cart/Lift Model	Follower	Follower Description	Material
CL0409A91LL2DE31	Cart Mount w/Lift	AF0409A91LL2D-1	67075-1-B	67486-1	Single Lip, Polyethylene/Urethane	Carbon Steel, Electroless Nickel Coating
CL0409A91LL2DE3B*	Cart Mount w/Lift	AF0409A91LL2D-1	67075-1-B	67486-1	Single Lip, Polyethylene/Urethane	Carbon Steel, Electroless Nickel Coating

*Includes Application Kit with Control Handle and Material Hose

Recommended Accessories



Airless Spray Guns

651533 Wetted parts of 316 stainless, 5,000 psi 1/4" NPS(M). Used for light fluids. Order TC-XXXX airless spray tip separately.
651500-1 Wetted Parts Stainless; 7500 psi, 3/8" NPTF Inlet. For materials over 200,000 cPs. Order TC-XXXX for spray tips separately.



Airless Spray Tips

Typical spray orifices sizes (see accessory catalog for more options):
TC-1850: 0.018" (.46mm), **TC-2140:** 0.021" (.53mm), **TC-2640:** 0.026" (.66mm)



Swivel

636085 Straight, 3/8" (M) x 3/8" (F) / fabric with neoprene / 8,000 psi (552 bar) max. working pressure
636088 Z-360°, 3/8" (M) x 3/8" (F) / fabric with neoprene / 8,000 psi (552 bar) max. working pressure
75364 Straight, for use with 651533 gun / 1/4"-18 NPTF to 1/4"-18 NPSM / 10,000 psi (690 bar) max working pressure



Material Filters

1/2" F (2) inlet 1/2" F (1) outlet / 6,000 psi (414 bar) max. / 200 micron
651420-70 for Carbon Steel
651422-70 for Stainless Steel



3/8" Fluid Pressure Regulators

651780-A3A-B Regulated 400 – 1,250 psi (28 – 86 bar) / 3,000 psi (207 bar) max. inlet / stainless steel
651780-B1A-B Regulated 400 – 1,250 psi (28 – 86 bar) / 3,000 psi (207 bar) max. inlet / carbon steel
651780-B1B-B Regulated 1,000 – 3,000 psi (69 – 345 bar) / 6,000 psi (414 bar) max. inlet / carbon steel
651780-B3R-B Regulated 400 – 5,000 psi (28 – 345 bar) / 6,000 psi (414 bar) max. inlet / stainless steel

Other Accessories & Repair Kits

62274	Air Line Oil
96916	Standard Air Motor Muffler
66333-B	Wet-Sol (1 Quart)
F35341-400	Filter
104317	Filter Element
637489	Universal Air Motor Service Kit

9:1
4-1/4"

**AFX
Series**

AF0409 Series Pumps



(Model shown w/ ball valve regulator)

Materials: Oils, Paint, Coatings, Chemicals

Pump Specifications

Ratio	9:1
Stroke (double acting)	4" (10.2 cm)
Material Inlet	1-1/4" NPT(F)
Material Outlet	3/4" NPT(F)
Air Inlet (female)	1/2" NPT(F)
Air Inlet Pressure Range psi (bar)	30 - 150 (2 - 10.3)
Fluid Pressure Range psi (bar)	270 - 1350 (18.6 - 93.1)
Max Cycles/Minute	60
Displacement/Cycle cu in (cm3)	11.0 (180.2)
Cycles/gal (L)	21 (5.5)
Flow @ 60 Cycles gpm (L/min)	2.9 (10.8)
Noise Level @ 60 psi dBA	89.2
Weight* lb (kg)	5 Gallon 35 (15.9) 55 Gallon 45 (20.4)

*Estimated weight. Contact Technical Support for exact weight.

DIMENSIONS 5-GALLON UNIT

A ¹ in (mm)	34.12 (866.55)
B in (mm)	17.78 (451.7)
C in (mm)	11 (279.4)

DIMENSIONS 55-GALLON UNIT

A ¹ in (mm)	57.46 (1459.48)
B in (mm)	41.12 (1044.55)
C in (mm)	34.34 (872.34)

¹For models without ball valve regulator subtract 2.08 in (52.83 mm)

PERFORMANCE BASED ON 30wt. OIL (100 cSt) AT 40° C TEMPERATURE

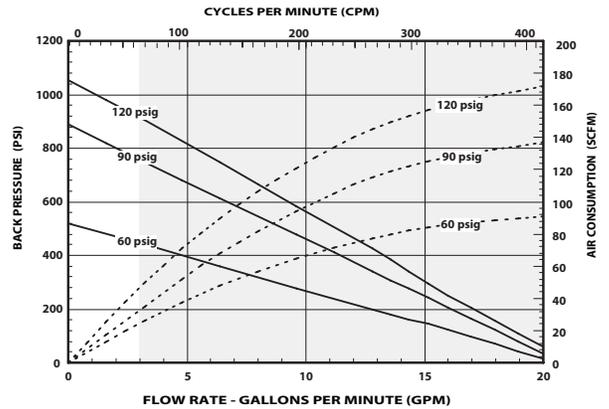

PERFORMANCE BASED ON 30wt. OIL (100 cSt) AT 40° C TEMPERATURE

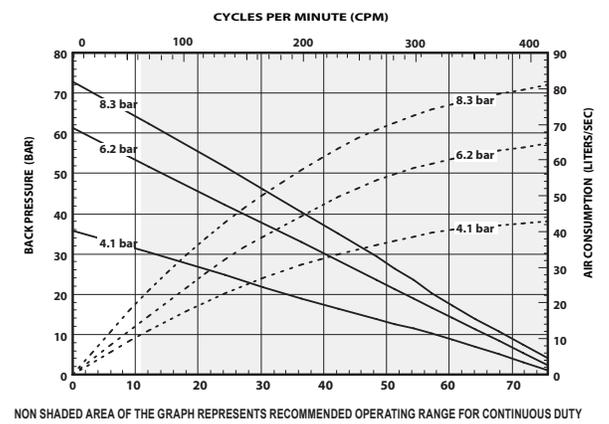

Pump Model**	Container Suitability	Plunger Material	Upper Packings	Lower Packings	Lower Pump Model	Lower Pump Mounting Footprint	Pump Service Kit
Lower Pump Material - 316 Stainless Steel							
AF0409C11FF22	5 Gallon	316 Stainless Steel	UHMW-PE	UHMW-PE	1875C11FF22	C	K1875C11FF00
AF0409C11FF29	5 Gallon	304 Stainless Steel, Ceramic Coated	UHMW-PE	UHMW-PE	1875C11FF29	C	K1875C11FF00
AF0409C11SS22	5 Gallon	316 Stainless Steel	Virgin PTFE	Virgin PTFE	1875C11SS22	C	K1875C11SS00
AF0409C11VF2E	5 Gallon	316 Stainless Steel, Ceramic Coated Tube	Viton	UHMW-PE	1875C11VF2E	C	K1875C11VF00
AF0409C11VF29	5 Gallon	304 Stainless Steel, Ceramic Coated	Viton	UHMW-PE	1875C11VF29	C	K1875C11VF00
AF0409C51SS22	55 Gallon	316 Stainless Steel	Virgin PTFE	Virgin PTFE	1875C51SS22	C	K1875C11SS00
AF0409C51FF22	55 Gallon	316 Stainless Steel	UHMW-PE	UHMW-PE	1875C51FF22	C	K1875C11FF00

**Add "-1" to Model No. for Ball Valve Regulator

Recommended Accessories



67445-1
Muffler Kit



66334-B
Wet-Sol Packing Lubricant



23644-400
ARO-Stop Valve



67136
Floor/Follower Plate Adapter



67442
Ball Valve Regulator



637489
Universal Air Motor Service Kit

9:1 Ratio Pump Packages



**ALX Series
Drum Cover Agitator w/Lift**

55
GALLON

Packages					
Model No.	Package Type	Pump Model	Lift Model	Drum Cover	Material Hose
AL0409C51FF22002	Drum Cover w/Agitator Lift	AF0409C51FF22	640067	66197	623600-10

Recommended Accessories



Airless Spray Guns

651533 Wetted parts of 316 stainless, 5,000 psi 1/4" NPS(M).
Used for light fluids. Order TC-XXXX airless spray tip separately.
651500-1 Wetted Parts Stainless Steel; 7500 psi, 3/8" NPTF Inlet.
For materials over 200,000 cPs. Order TC-XXXX for spray tips separately.



Airless Spray Tips

Typical spray orifices sizes (see accessory catalog for more options):
TC-1850: 0.018" (.46mm), **TC-2140:** 0.021" (.53mm), **TC-2640:** 0.026" (.66mm)



Swivel

636085 Straight, 3/8" (M) x 3/8" (F) / fabric with neoprene /
8,000 psi (552 bar) max. working pressure
636088 Z-360°, 3/8" (M) x 3/8" (F) / fabric with neoprene /
8,000 psi (552 bar) max. working pressure
75364 Straight, for use with 651533 gun / 1/4"-18 NPTF to 1/4"-18 NPSM /
10,000 psi (690 bar) max working pressure



Material Filters

1/2" F inlet 1/2" F (1) outlet / 6,000 psi (414 bar) max. / 200 micron
651420-70 for Carbon Steel
651422-70 for Stainless Steel



3/8" Fluid Pressure Regulators

651780-A3A-B Regulated 400 – 1,250 psi (28 – 86 bar) /
3,000 psi (207 bar) max. inlet / stainless steel
651780-B1A-B Regulated 400 – 1,250 psi (28 – 86 bar) /
3,000 psi (207 bar) max. inlet / carbon steel
651780-B1B-B Regulated 1,000 – 3,000 psi (69 – 345 bar) /
6,000 psi (414 bar) max. inlet / carbon steel
651780-B3R-B Regulated 400 – 5,000 psi (28 – 345 bar) /
6,000 psi (414 bar) max. inlet / stainless steel

Other Accessories & Repair Kits

62274	Air Line Oil
96916	Standard Air Motor Muffler
66333-B	Wet-Sol (1 Quart)
P39344-100	Filter/Regulator
104327	Filter/Regulator Repair Kit
637489	Universal Air Motor Service Kit

10:1

8"

AFX
Series

AF0810 Series Pumps

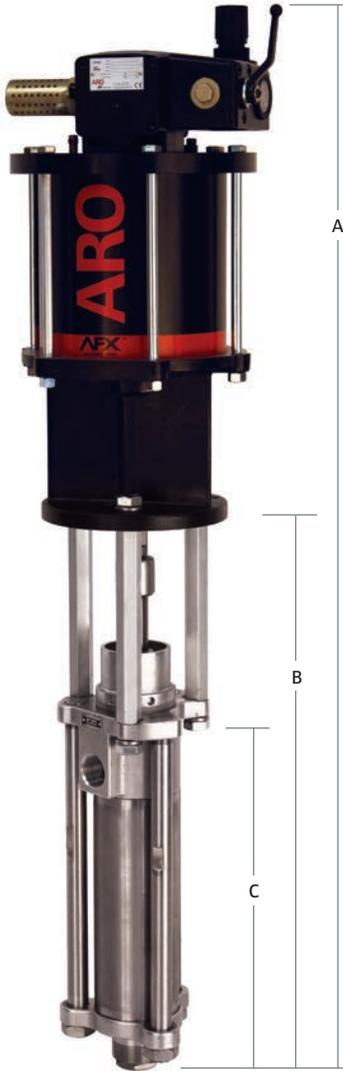

(Model shown w/ball valve regulator)

Materials: Oils, Paint, Coatings, Chemicals**Pump Specifications**

Ratio	10:1
Stroke (double acting)	6" (15.24 cm)
Material Inlet	2" NPT(F)
Material Outlet	1-1/4" NPT(F)
Air Inlet (female)	3/4" NPT(F)
Air Inlet Pressure Range psi (bar)	30 - 120 (2.1 - 8.3)
Fluid Pressure Range psi (bar)	300 - 1200 (20.7 - 82.7)
Max Cycles/Minute	60
Displacement/Cycle cu in (cm ³)	59.9 (979.9)
Cycles/gal (L)	3.9 (1.0)
Flow @ 60 Cycles gpm (L/min)	15.6 (58.9)
Noise Level @ 60 psi dBA	86.8
Weight* lb (kg)	102 (46.3)
Container Suitability	Remote Mounting

*Estimated weight. Contact Technical Support for exact weight.

DIMENSIONS

A' in (mm)	49.43 (1255.5)
B in (mm)	26.37 (669.90)
C in (mm)	14.81 (376.22)

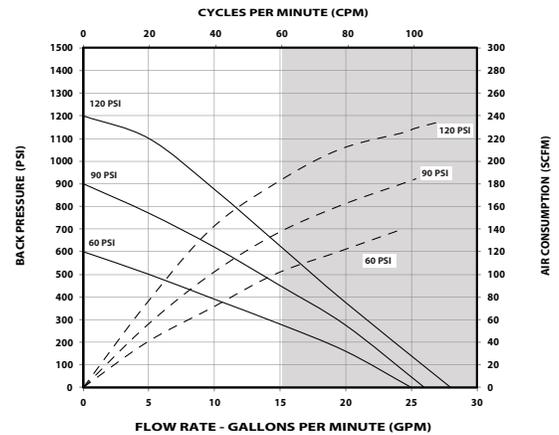
¹For models without ball valve regulator subtract 2.08 in (52.83 mm)**PERFORMANCE BASED ON 30wt. OIL (100 cSt) AT 40° C TEMPERATURE**

NON SHADED AREA OF THE GRAPH REPRESENTS RECOMMENDED OPERATING RANGE FOR CONTINUOUS DUTY

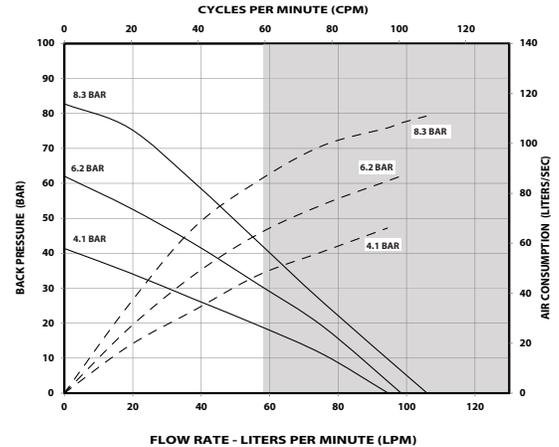
PERFORMANCE BASED ON 30wt. OIL (100 cSt) AT 40° C TEMPERATURE

NON SHADED AREA OF THE GRAPH REPRESENTS RECOMMENDED OPERATING RANGE FOR CONTINUOUS DUTY

Pump Model**	Plunger Material	Upper Packings	Lower Packings	Lower Pump Model	Lower Pump Mounting Footprint	Pump Service Kit
Lower Pump Model Material - 300 Series / CF8M Stainless Steel						
AF0810C11CC15	321 Stainless Steel w/Hard Chrome	Carbon-Graphite Filled PTFE	Carbon-Graphite Filled PTFE	66942-K3F	D	637211-K33
AF0810C11FF35	321 Stainless Steel w/Hard Chrome	UHMW-PE	UHMW-PE	66942-C6F	D	637211-C63
AF0810C11KK35	321 Stainless Steel w/Hard Chrome	Mineral Filled PTFE	Mineral Filled PTFE	66942-L6F	D	637211-L63
AF0810C11GF35	321 Stainless Steel w/Hard Chrome	UHMW-PE/Mineral Filled PTFE (Staggered)	UHMW-PE	66942-P6F	D	637211-P63
Lower Pump Model Material - 400 Series Stainless Steel						
AF0810F11FF36	15-5 Stainless Steel w/Hard Chrome	UHMW-PE	UHMW-PE	66941-C6D	D	637211-C63
AF0810F11KK36	15-5 Stainless Steel w/Hard Chrome	Mineral Filled PTFE	Mineral Filled PTFE	66941-L6D	D	637211-L63
AF0810F11RK36	15-5 Stainless Steel w/Hard Chrome	Mineral Filled PTFE/ UHMW-PE (Staggered)	Mineral Filled PTFE	66941-R6D	D	637211-R63

**Add "-1" to Model No. for Ball Valve Regulator

Recommended Accessories67445-3
Muffler Kit66334-B
Wet-Sol Air Motor
Lubricant23644-400
ARO-Stop
Valve67442
Ball Valve
Regulator637489
Universal Air Motor
Service Kit

11:1
4-1/4"

**AFX
Series**

AF0411 Series Pumps



(Model shown w/ball valve regulator)

Materials: Oils, Paint, Coatings, Chemicals

Pump Specifications

- Ratio 11:1
- Stroke (double acting) 6" (15.24 cm)
- Material Inlet 1" NPT(F)
2" PTF SAE Short (M)
- Material Outlet 1" NPT(F)
- Air Inlet (female) 1/2" NPT(F)
- Air Inlet Pressure Range 30 - 150
psi (bar) (2 - 10.3)
- Fluid Pressure Range 330 - 1747
psi (bar) (23 - 120)
- Max Cycles/Minute 60
- Displacement/Cycle cu in (cm3) 14.5 (237.6)
- Cycles/gal (L) 15.9 (4.2)
- Flow @ 60 Cycles gpm (L/min) 3.7 (14.0)
- Noise Level @ 60 psi dBA 86.5
- Weight* lb (kg) 42.9 (19.5)
- Container Suitability Remote
Mounting

*Estimated weight. Contact Technical Support for exact weight.

DIMENSIONS

A' in (mm)	42.18 (1071.47)
B in (mm)	18.91(480.34)
C in (mm)	12.66 (321.59)

¹For models without ball valve regulator subtract 2.08 in (52.83 mm)

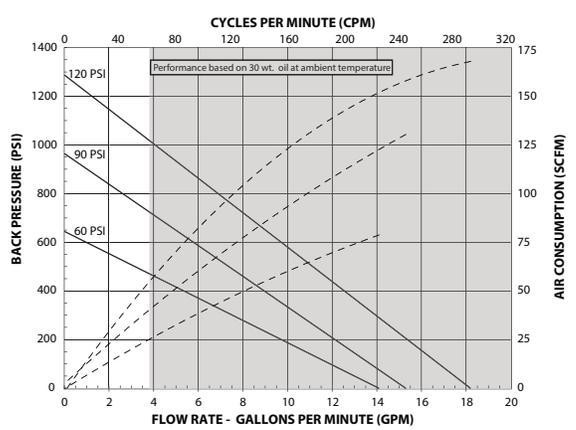

NON SHADED AREA OF THE GRAPH REPRESENTS RECOMMENDED OPERATING RANGE FOR CONTINUOUS DUTY

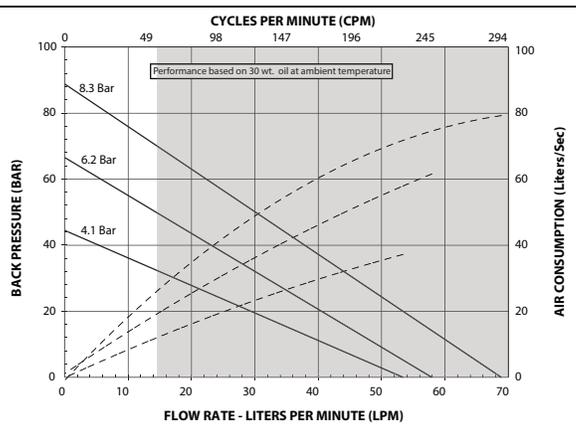

NON SHADED AREA OF THE GRAPH REPRESENTS RECOMMENDED OPERATING RANGE FOR CONTINUOUS DUTY

Pump Model**	Plunger Material	Upper Packings	Lower Packings	Lower Pump Model	Lower Pump Mounting Footprint	Pump Service Kit
Lower Pump Material - 300 Series SS w/ Tungsten Carbide Seat						
AF0411G11FF47	17-4 Stainless w/Hard Chrome	UHMW-PE	UHMW-PE	66300-C43	D	637305-C43
AF0411G11KK47	17-4 Stainless w/Hard Chrome	Glass Filled PTFE	Glass Filled PTFE	66300-343	D	637305-343
AF0411G11KK48	17-4 Stainless, Ceramic Coated	Glass Filled PTFE	Glass Filled PTFE	66300-34B	D	637305-343
AF0411G11HH47	17-4 Stainless w/Hard Chrome	UHMW-PE/Leather (Staggered)	UHMW-PE/Leather (Staggered)	66300-G43	D	637305-G43
AF0411G11GF47	17-4 Stainless w/Hard Chrome	UHMW-PE/Glass Filled PTFE (Staggered)	UHMW-PE	66300-P43	D	637305-P43
AF0411G11RK47	17-4 Stainless w/Hard Chrome	Glass Filled PTFE/UHMW-PE (Staggered)	Glass Filled PTFE	66300-R43	D	637305-R43
AF0411G11FF48	17-4 Stainless, Ceramic Coated	UHMW-PE	UHMW-PE	66300-C4B	D	637305-C43
AF0411G11GF48	17-4 Stainless, Ceramic Coated	UHMW-PE/Glass Filled PTFE (Staggered)	UHMW-PE	66300-P4B	D	637305-P43
AF0411G11RK48	17-4 Stainless, Ceramic Coated	Glass Filled PTFE/UHMW-PE (Staggered)	Glass Filled PTFE	66300-R4B	D	637305-R43

**Add "-1" to Model No. for Ball Valve Regulator

Recommended Accessories

67445-1 Muffler Kit	66334-B Wet-Sol Packing Lubricant	23644-400 ARO-Stop Valve	67136 Floor/Follower Plate Adapter	67442 Ball Valve Regulator	637489 Universal Air Motor Service Kit

11:1 Ratio Pump Packages



**TPX Series
Two-Post Ram**



Packages						
Model No.	Package Type	Pump Model	Ram Model	Follower	Follower Description	Material
TP0411G21FF48A72	5 Gallon Two Post Ram	AF0411G11FF48	RM052S-C	67347-2	Single Tube, EPR	Aluminum
TP0411G51GF47AA2	55 Gallon Two Post Ram	AF0411G11GF47	RM552S-C	66516-1	Double Lip, Polyurethane	Aluminum
TP0411G21FF48A82	5 Gallon Two Post Ram	AF0411G11FF48	RM052S-C	67347-1	Single Tube, Buna	Aluminum

Recommended Accessories



Airless Spray Guns

651533 Wetted parts of 316 stainless, 5,000 psi 1/4" NPS(M). Used for light fluids. Order TC-XXXX airless spray tip separately.
651500-1 Wetted Parts Stainless Steel; 7500 psi, 3/8" NPTF Inlet. For materials over 200,000 cPs. Order TC-XXXX for spray tips separately.



Airless Spray Tips

Typical spray orifices sizes (see accessory catalog for more options):
TC-1850: 0.018" (.46mm), **TC-2140:** 0.021" (.53mm), **TC-2640:** 0.026" (.66mm)

Swivel



636085 Straight, 3/8" (M) x 3/8" (F) / fabric with neoprene / 8,000 psi (552 bar) max. working pressure
636088 Z-360°, 3/8" (M) x 3/8" (F) / fabric with neoprene / 8,000 psi (552 bar) max. working pressure
75364 Straight, for use with 651533 gun / 1/4"-18 NPTF to 1/4"-18 NPSM / 10,000 psi (690 bar) max working pressure

Material Filters

1/2" F (2) inlet 1/2" F (1) outlet / 6,000 psi (414 bar) max. / 200 micron
651420-70 for Carbon Steel
651422-70 for Stainless Steel

3/8" Fluid Pressure Regulators

651780-A3A-B Regulated 400 – 1,250 psi (28 – 86 bar) / 3,000 psi (207 bar) max. inlet / stainless steel
651780-B1A-B Regulated 400 – 1,250 psi (28 – 86 bar) / 3,000 psi (207 bar) max. inlet / carbon steel
651780-B1B-B Regulated 1,000 – 3,000 psi (69 – 345 bar) / 6,000 psi (414 bar) max. inlet / carbon steel
651780-B3R-B Regulated 400 – 5,000 psi (28 – 345 bar) / 6,000 psi (414 bar) max. inlet / stainless steel



Other Accessories & Repair Kits

62274	Air Line Oil
96916	Standard Air Motor Muffler
66333-B	Wet-Sol (1 Quart)
66354-1	Stabilizing Bracket
637489	Universal Air Motor Service Kit
637466	5 Gallon Two Post Ram Repair Kit
67480	55 Gallon Two Post Ram Cross Over Kit
67481	5 Gallon Two Post Ram Cross Over Kit
637491	55 Gallon Two Post Ram Repair Kit (RM552S-X)
67500	Low-Level Cut-Off Kit
67503	55 Gallon Drum Hold Down Kit

15:1

10"

**AFX
Series**

AF1015 Series Pumps

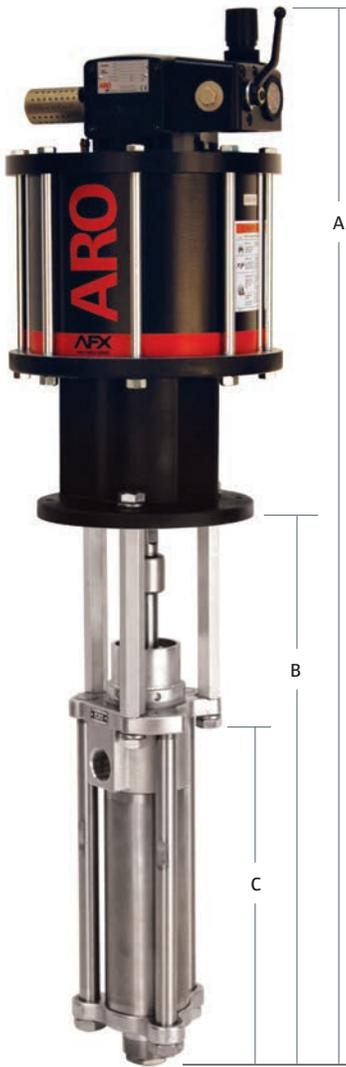

(Model shown w/ball valve regulator)

Materials: Oils, Paint, Coatings, Chemicals

Pump Specifications

Ratio	15:1
Stroke (double acting)	6" (15.24 cm)
Material Inlet	2" NPT(F)
Material Outlet	1-1/4" NPT(F)
Air Inlet (female)	3/4" NPT(F)
Air Inlet Pressure Range psi (bar)	30 - 90 (2.1 - 6.2)
Fluid Pressure Range psi (bar)	450 - 1350 (31.0 - 93.1)
Max Cycles/Minute	60
Displacement/Cycle cu in (cm3)	59.8 (979.9)
Cycles/gal (L)	3.9 (1.0)
Flow @ 60 Cycles gpm (L/min)	15.5 (58.7)
Noise Level @ 60 psi dBA	89.8
Weight* lb (kg)	125 (56.7)
Container Suitability	Remote Mounting

*Estimated weight. Contact Technical Support for exact weight.

DIMENSIONS

A ¹ in (mm)	49.43 (1255.5)
B in (mm)	26.37 (669.90)
C in (mm)	14.81 (376.22)

¹For models without ball valve regulator subtract 2.08 in (52.83 mm)

PERFORMANCE BASED ON 30wt. OIL (100 cSt) AT 40° C TEMPERATURE
CYCLES PER MINUTE (CPM)

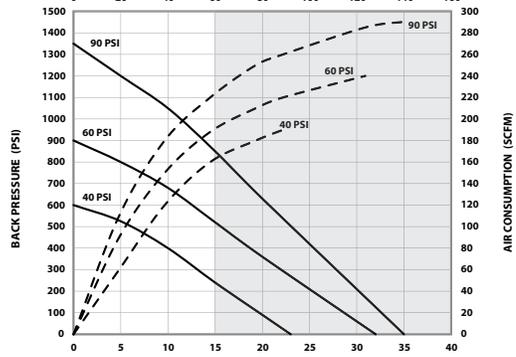

NON SHADED AREA OF THE GRAPH REPRESENTS RECOMMENDED OPERATING RANGE FOR CONTINUOUS DUTY

PERFORMANCE BASED ON 30wt. OIL (100 cSt) AT 40° C TEMPERATURE
CYCLES PER MINUTE (CPM)

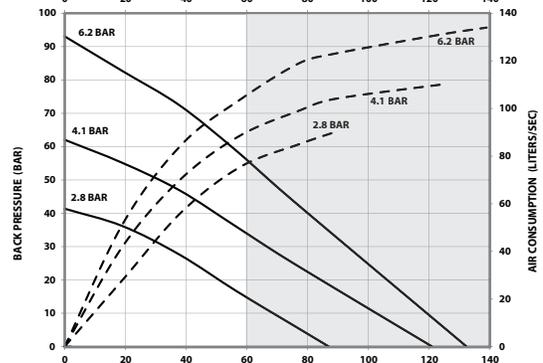

NON SHADED AREA OF THE GRAPH REPRESENTS RECOMMENDED OPERATING RANGE FOR CONTINUOUS DUTY

Pump Model**	Plunger Material	Upper Packings	Lower Packings	Lower Pump Model	Lower Pump Mounting Footprint	Pump Service Kit
Lower Pump Material – 300 Series / CF8M Stainless Steel						
AF1015C11FF35	321 Stainless Steel w/Hard Chrome	UHMW-PE	UHMW-PE	66942-C6F	D	637211-C63
AF1015C11GF35	321 Stainless Steel w/Hard Chrome	UHMW-PE/Mineral Filled PTFE (Staggered)	UHMW-PE	66942-P6F	D	637211-P63
Lower Pump Model Material – 400 Series SS w/Tungsten Carbide Seat						
AF1015J11FF36	15-5 Stainless Steel w/Hard Chrome	UHMW-PE	UHMW-PE	66941-CDD	D	637211-C63
Lower Pump Model Material – 400 Series Stainless Steel						
AF1015F11FF36	15-5 Stainless Steel w/Hard Chrome	UHMW-PE	UHMW-PE	66941-C6D	D	637211-C63
AF1015F11KK36	15-5 Stainless Steel w/Hard Chrome	Mineral Filled PTFE	Mineral Filled PTFE	66941-L6D	D	637211-L63
AF1015F11RK36	15-5 Stainless Steel w/Hard Chrome	Mineral Filled PTFE/UHMW-PE (Staggered)	Mineral Filled PTFE	66941-R6D	D	637211-R63

**Add "-1" to Model No. for Ball Valve Regulator

Recommended Accessories



67445-4
Muffler Kit



66334-B
Wet-Sol Packing
Lubricant



635043
ARO-Stop
Valve



67136
Floor/Follower
Plate Adapter



67442
Ball Valve
Regulator



637489
Universal Air Motor
Service Kit

18:1

3"

N
Series

NM2318B-13-X43 Series Pumps

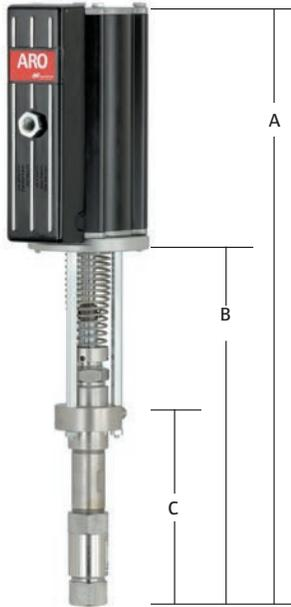

Materials: Paint, Coatings

Pump Specifications

Ratio	18:1
Stroke in (mm)	3 (76)
Material Inlet	1/2" NPT(F)
Material Outlet	1/4" NPT(F)
Air Inlet (female)	1/4" NPT(F)
Air Inlet Pressure Range psi (bar)	30-150 (2.1-10.3)
Fluid Pressure Range psi (bar)	540-2,700 (37.2-186.2)
Max Cycles/Minute	120
Displacement/Cycle cu in (cm3)	2.35 (38.5)
Cycles/gal (L)	98.3 (26.5)
Flow @ 60 Cycles gpm (L/min)	0.60 (2.3)
Noise Level @ 100 psi dBA	85
Weight* lb (kg)	12.6 (5.7)

* Estimated weight. Contact Technical Support for exact weight.

Model	A in (mm)	B in (mm)	C in (mm)
NM2318B-13-X43	23.187 (563.6)	13.812 (334.2)	6.937 (175.4)

PERFORMANCE BASED ON 30wt. OIL (100 cSt) AT 40° C TEMPERATURE

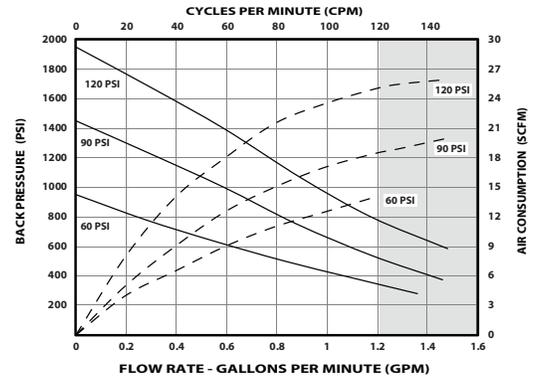

NON SHADED AREA OF THE GRAPH REPRESENTS RECOMMENDED OPERATING RANGE FOR CONTINUOUS DUTY

PERFORMANCE BASED ON 30wt. OIL (100 cSt) AT 40° C TEMPERATURE

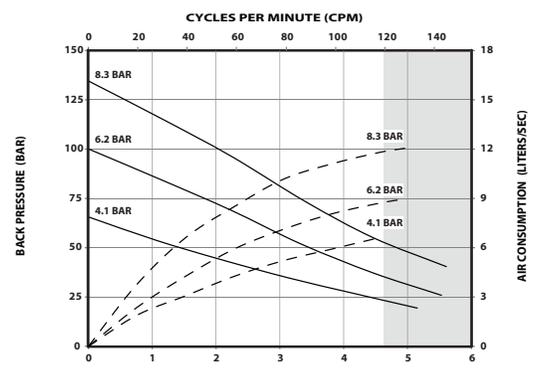

NON SHADED AREA OF THE GRAPH REPRESENTS RECOMMENDED OPERATING RANGE FOR CONTINUOUS DUTY

Pump Model	Lower Pump Material	Plunger Material	Upper Packings	Lower Packings	Pump Service Kit*
Lower Pump Material - Stainless Steel					
NM2318B-13-C43	304 Stainless Steel	17-4 Stainless Steel	UHMW-PE	UHMW-PE	637394-X43
NM2318B-13-L43	304 Stainless Steel	17-4 Stainless Steel	PTFE	PTFE	637394-X43

* Lower pump repair kit

Recommended Accessories



P29122-600
Piggyback F/R



635040
ARO-Stop
Valve



95015
Wall
Mount



66333-B
Wet Sol



651533
Airless
Spray
Gun



637316
Air Motor
Service
Kit

TC1550
Airless
Spray
Nozzle

628042-25
Hose
Assembly

22:1
4-1/4"

AFX Series

AF0422 Series Pumps



(Model shown w/ball valve regulator)

Materials: Oils, Paint, Coatings, Chemicals

Pump Specifications

Ratio	22:1
Stroke (double acting)	6" (15.24 cm)
Material Inlet	1" NPT(F) 2" PTF SAE Short (M)
Material Outlet	1" NPT(F)
Air Inlet (female)	1/2" NPT(F)
Air Inlet Pressure Range psi (bar)	30 - 150 (2 - 10.3)
Fluid Pressure Range psi (bar)	660 - 3300 (46 - 228)
Max Cycles/Minute	60
Displacement/Cycle cu in (cm3)	7.5 (122.9)
Cycles/gal (L)	30.9 (8.1)
Flow @ 60 Cycles gpm (L/min)	1.9 (7.2)
Noise Level @ 60 psi dBA	86.5
Weight* lb (kg)	42.9 (19.5)
Container Suitability	Remote Mounting

*Estimated weight. Contact Technical Support for exact weight.

DIMENSIONS

A ¹ in (mm)	42.18 (1071.47)
B in (mm)	18.91 (480.34)
C in (mm)	12.66 (321.59)

¹For models without ball valve regulator subtract 2.08 in (52.83 mm)

Performance Based on 30wt Oil (100 cSt) at 40° C Temperature
Cycles Per Minute (CPM)

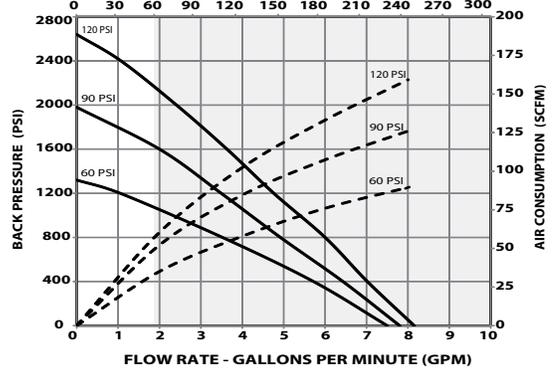

NON SHADED AREA OF THE GRAPH REPRESENTS RECOMMENDED OPERATING RANGE FOR CONTINUOUS DUTY

Performance Based on 30wt Oil (100 cSt) at 40° C Temperature
Cycles Per Minute (CPM)

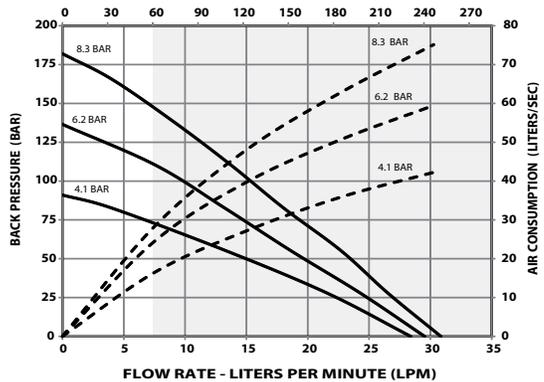

NON SHADED AREA OF THE GRAPH REPRESENTS RECOMMENDED OPERATING RANGE FOR CONTINUOUS DUTY

Pump Model**	Plunger Material	Upper Packings	Lower Packings	Lower Pump Model	Lower Pump Mounting Footprint	Pump Service Kit
Lower Pump Material - 300 Series SS w/Tungsten Carbide Seat						
AF0422G11FF47	17-4 Stainless Steel w/Hard Chrome	UHMW-PE	UHMW-PE	66301-C43	D	637306-C43
AF0422G11KK47	17-4 Stainless Steel w/Hard Chrome	Glass Filled PTFE	Glass Filled PTFE	66301-343	D	637306-343
AF0422G11HH47	17-4 Stainless Steel w/Hard Chrome	UHMW-PE/Leather (Staggered)	UHMW-PE/Leather (Staggered)	66301-G43	D	637306-G43
AF0422G11GF47	17-4 Stainless Steel w/Hard Chrome	UHMW-PE/Glass Filled PTFE (Staggered)	UHMW-PE	66301-P43	D	637306-P43
AF0422G11RK47	17-4 Stainless Steel w/Hard Chrome	Glass Filled PTFE/UHMW-PE (Staggered)	Glass Filled PTFE	66301-R43	D	637306-R43
AF0422G11RK48	17-4 Stainless Steel Ceramic Coated	Glass Filled PTFE/UHMW-PE (Staggered)	Glass Filled PTFE	66301-R4B	D	637306-R43

**Add "-1" to Model No. for Ball Valve Regulator

Recommended Accessories



67445-1
Muffler Kit



66334-B
Wet-Sol Packing
Lubricant



23644-400
ARO-Stop
Valve



67136
Floor/Follower
Plate Adapter



67442
Ball Valve
Regulator



637489
Universal Air Motor
Service Kit

23:1

6"

AFX Series

AF0623 Series Pumps



(Model shown w/ ball valve regulator)

Materials: Oils, Paint, Coatings, Chemicals

Pump Specifications

Ratio	23:1
Stroke (double acting)	6" (15.24 cm)
Material Inlet	1" NPT(F) 2" PTF SAE Short(M)
Material Outlet	1" NPT(F)
Air Inlet (female)	1/2" NPT(F)
Air Inlet Pressure Range	30 - 150 psi (bar) (2.1 - 10.3)
Fluid Pressure Range	690 - 3495 psi (bar) (47.6 - 241)
Max Cycles/Minute	60
Displacement/Cycle cu in (cm ³)	14.5 (237.6)
Cycles/gal (L)	15.9 (4.2)
Flow @ 60 Cycles gpm (L/min)	3.7 (14.0)
Noise Level @ 60 psi dBA	84.7
Weight* lb (kg)	46.2 (21)
Container Suitability	Remote Mounting

*Estimated weight. Contact Technical Support for exact weight.

DIMENSIONS

A ¹ in (mm)	42.18 (1071.47)
B in (mm)	18.91 (480.34)
C in (mm)	12.66 (321.59)

¹For models without ball valve regulator subtract 2.08 in (52.83 mm)

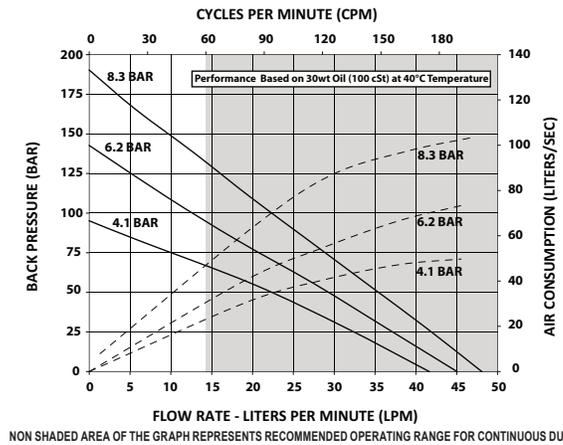
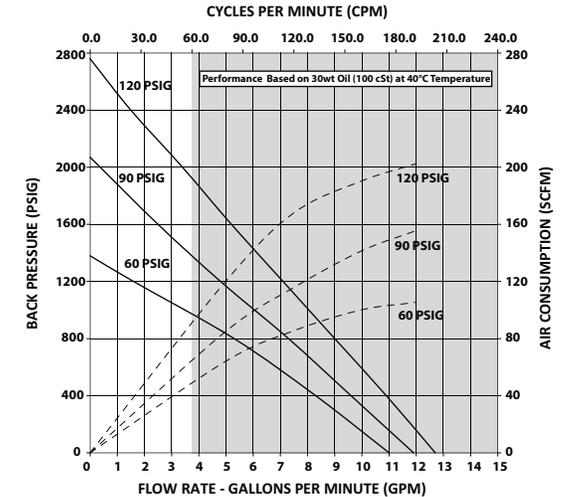

Pump Model**	Plunger Material	Upper Packings	Lower Packings	Lower Pump Model	Lower Pump Mounting Footprint	Pump Service Kit
Lower Pump Material - 300 Series SS w/ Tungsten Carbide Seat						
AF0623G11FF47	17-4 SS w/Hard Chrome	UHMW-PE	UHMW-PE	66300-C43	D	637305-C43
AF0623G11KK47	17-4 SS w/Hard Chrome	Glass Filled PTFE	Glass Filled PTFE	66300-343	D	637305-343
AF0623G11KK48	17-4 SS, Ceramic Coated	Glass Filled PTFE	Glass Filled PTFE	66300-34B	D	637305-343
AF0623G11HH47	17-4 Stainless Steel w/Hard Chrome	UHMW-PE/Leather (Staggered)	UHMW-PE/Leather (Staggered)	66300-G43	D	637305-G43
AF0623G11HH48	17-4 Stainless Steel, Ceramic Coated	UHMW-PE/Leather (Staggered)	UHMW-PE/Leather (Staggered)	66300-G4B	D	637305-G43
AF0623G11GF47	17-4 Stainless Steel w/Hard Chrome	UHMW-PE/Glass Filled PTFE (Staggered)	UHMW-PE	66300-P43	D	637305-P43
AF0623G11RK48	17-4 Stainless Steel, Ceramic Coated	Glass Filled PTFE/UHMW-PE (Staggered)	Glass Filled PTFE	66300-R4B	D	637305-R43
AF0623G11RK47	17-4 Stainless Steel w/Hard Chrome	Glass Filled PTFE/UHMW-PE (Staggered)	Glass Filled PTFE	66300-R43	D	637305-R43
AF0623G11FF48	17-4 SS, Ceramic Coated	UHMW-PE	UHMW-PE	66300-C4B	D	637305-C43
AF0623G11GF48	17-4 Stainless, Ceramic Coated	UHMW-PE/Glass Filled PTFE (Staggered)	UHMW-PE	66300-P4B	D	637305-P43

**Add "-1" to Model No. for Ball Valve Regulator

Recommended Accessories



67445-2
Muffler Kit

66334-B
Wet-Sol Packing
Lubricant

23644-400
ARO-Stop
Valve

67136
Floor/Follower
Plate Adapter

67442
Ball Valve
Regulator

637489
Universal Air Motor
Service Kit

23:1 Pump Packages on following page.

23:1 Ratio Pump Packages



**TPX Series
Two Post Ram**

**55
GALLON**

Packages						
Model No.	Package Type	Pump Model	Ram/Lift Model	Follower	Follower Description	Material
TP0623G51RK47TA2	55 Gallon Two Post Ram	AF0623G11RK47	RM552S-C	66516-6	Double Lip, Polyurethane	Aluminum w/PTFE Coating

Recommended Accessories



Airless Spray Guns

651533 Wetted parts of 316 stainless, 5,000 psi 1/4" NPS(M).
Used for light fluids. Order TC-XXXX airless spray tip separately.
651500-1 Wetted Parts Stainless Steel; 7500 psi, 3/8" NPTF Inlet.
For materials over 200,000 cPs. Order TC-XXXX for spray tips separately.



Airless Spray Tips

Typical spray orifices sizes (see accessory catalog for more options):
TC-1850: 0.018" (.46mm), **TC-2140:** 0.021" (.53mm), **TC-2640:** 0.026" (.66mm)



Swivel

636085 Straight, 3/8" (M) x 3/8" (F) / fabric with neoprene /
8,000 psi (552 bar) max. working pressure
636088 Z-360°, 3/8" (M) x 3/8" (F) / fabric with neoprene /
8,000 psi (552 bar) max. working pressure
75364 Straight, for use with 651533 gun / 1/4"-18 NPTF to 1/4"-18 NPSM /
10,000 psi (690 bar) max working pressure



Material Filters

1" F (2) inlet 3/8" F (3) outlet / 6,000 psi (414 bar) max. / Carbon Steel
651418-40-B for 40 Mesh (375 Microns)
651418-70-B for 70 Mesh (200 Microns)



3/4" Fluid Pressure Regulators

651780-C1B-B Regulated 750 – 2,500 psi (52 – 173 bar) /
6,000 psi (414 bar) max. inlet / carbon steel
651780-C1C-B Regulated 2,000 – 5,000 psi (138 – 345 bar) /
6,000 psi (414 bar) max. inlet / carbon steel
651780-C3B-B Regulated 750 – 2,500 psi /
6,000 psi (414 bar) max. inlet / stainless steel
651780-C3R-B Regulated 750 – 5,000 psi (52 – 345 bar) /
6,000 psi (414 bar) max. inlet / stainless steel

Other Accessories & Repair Kits

62274	Air Line Oil
96916	Standard Air Motor Muffler
66333-B	Wet-Sol (1 Quart)
66354-1	Stabilizing Kit
637489	Universal Air Motor Service Kit
637491	55 Gallon Two Post Ram Repair Kit (RM552S-X)
67480	55 Gallon Two Post Ram Cross Over Kit
67500	Low-Level Cut-Off Kit
67503	55 Gallon Drum Hold Down Kit

23:1

12"

AFX
Series

AF1223 Series Pumps



(Model shown w/ball valve regulator)

Materials: Oils, Paint, Coatings, Chemicals

Pump Specifications

Ratio	23:1
Stroke (double acting)	6" (15.24)
Material Inlet	2" NPT(F)
Material Outlet	1-1/4" NPT(F)
Air Inlet (female)	3/4" NPT(F)
Air Inlet Pressure Range psi (bar)	30 - 90 (2.1 - 6.2)
Fluid Pressure Range psi (bar)	690 - 2070 (47.6 - 142.8)
Max Cycles/Minute	60
Displacement/Cycle cu in (cm3)	59.8 (979.9)
Cycles/gal (L)	3.9 (1.0)
Flow @ 60 Cycles gpm (L/min)	15.5 (58.7)
Noise Level @ 60 psi dBA	93
Weight* lb (kg)	140 (63.5)
Container Suitability	Remote Mounting

*Estimated weight. Contact Technical Support for exact weight.

DIMENSIONS

A ¹ in (mm)	49.46 (1256.26)
B in (mm)	26.37 (669.89)
C in (mm)	14.81 (376.2)

¹For models without ball valve regulator subtract 2.08 in (52.83 mm)

PERFORMANCE BASED ON 30wt. OIL (100 cSt) AT 40° C TEMPERATURE

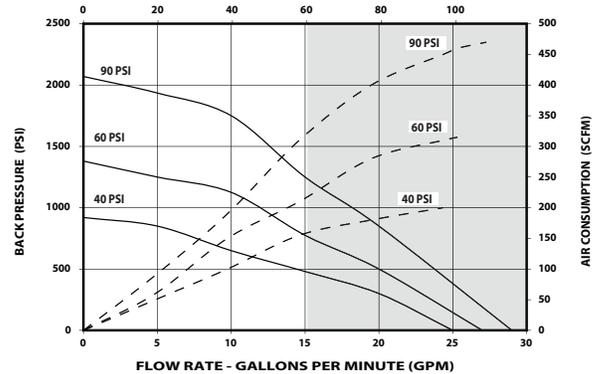

NON SHADED AREA OF THE GRAPH REPRESENTS RECOMMENDED OPERATING RANGE FOR CONTINUOUS DUTY

PERFORMANCE BASED ON 30wt. OIL (100 cSt) AT 40° C TEMPERATURE

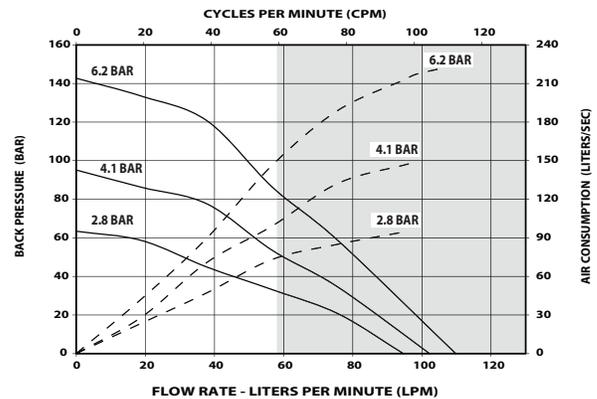

NON SHADED AREA OF THE GRAPH REPRESENTS RECOMMENDED OPERATING RANGE FOR CONTINUOUS DUTY

Pump Model**	Plunger Material	Upper Packings	Lower Packings	Lower Pump Model	Lower Pump Mounting Footprint	Pump Service Kit
Lower Pump Model Material – 300 Series / CF8M Stainless Steel						
AF1223C11CC15	321 Stainless Steel w/Hard Chrome	Carbon-Graphite Filled PTFE	Carbon-Graphite Filled PTFE	66942-K3F	D	637211-K33
AF1223C11FF35	321 Stainless Steel w/Hard Chrome	UHMW-PE	UHMW-PE	66942-C6F	D	637211-C63
Lower Pump Model Material – 400 Series Stainless Steel						
AF1223F11GF36	15-5 Stainless Steel w/Hard Chrome	UHMW-PE/Mineral Filled PTFE (Staggered)	UHMW-PE	66941-P6D	D	637211-P63
AF1223F11FF36	15-5 Stainless Steel w/Hard Chrome	UHMW-PE	UHMW-PE	66941-C6D	D	637211-C63

**Add "-1" to Model No. for Ball Valve Regulator

Recommended Accessories

67445-5
 Muffer Kit

66334-B
 Wet-Sol Packing
 Lubricant

635043
 ARO-Stop
 Valve

67136
 Floor/Follower
 Plate Adapter

67442
 Ball Valve
 Regulator

637489
 Universal Air Motor
 Service Kit

23:1

12"

AFX
Series

AF1223 Series Pumps

UV/EB 2-Ball Lower End



(Model shown w/ ball valve regulator)

Materials: Oils, Paint, Coatings, Chemicals

Pump Specifications

Ratio	23:1
Stroke (double acting)	6" (15.24 cm)
Material Inlet	Follower Plate Mounted
Material Outlet	1-1/4" NPT(F)
Air Inlet (female)	3/4" NPT(F)
Air Inlet Pressure Range psi (bar)	30 - 90 (2.1 - 6.2)
Fluid Pressure Range psi (bar)	690 - 2070 (47.6 - 142.8)
Max Cycles/Minute	60
Displacement/Cycle cu in (cm ³)	59.8 (980.12)
Cycles/gal (L)	3.9 (1.0)
Flow @ 60 Cycles gpm (L/min)	15.5 (58.7)
Noise Level @ 60 psi dBA	89.8
Weight* lb (kg)	200 (90.7)
Container Suitability	Remote Mounting

*Estimated weight. Contact Technical Support for exact weight.

DIMENSIONS

A [†] in (mm)	53.52 (1256.26)
B in (mm)	30.44 (669.89)
C in (mm)	18.88 (376.2)

[†]For models without ball valve regulator
subtract 2.08 in (52.83 mm)

PERFORMANCE BASED ON 30wt. OIL (100 cSt) AT 40° C TEMPERATURE

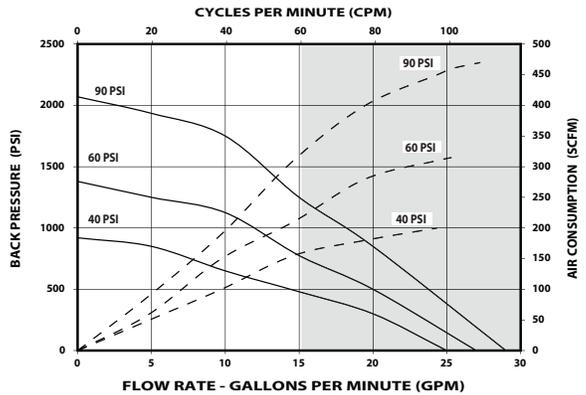

NON SHADED AREA OF THE GRAPH REPRESENTS RECOMMENDED OPERATING RANGE FOR CONTINUOUS DUTY

PERFORMANCE BASED ON 30wt. OIL (100 cSt) AT 40° C TEMPERATURE

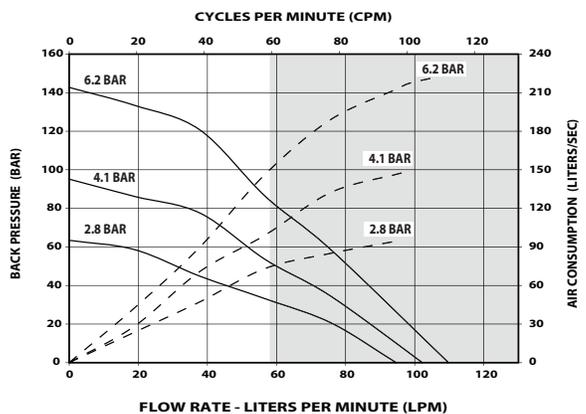

NON SHADED AREA OF THE GRAPH REPRESENTS RECOMMENDED OPERATING RANGE FOR CONTINUOUS DUTY

Pump Model**	Plunger Material	Upper Packings	Lower Packings	Lower Pump Model	Lower Pump Mounting Footprint	Pump Service Kit
Lower Pump Model Material - 300 Series / CF8M Stainless Steel w/ Large Inlet						
AF1223C51FF35	321 Stainless Steel w/Hard Chrome	UHMW-PE	UHMW-PE	67372-C6F	B	637444-C6D
AF1223C51FFP5*	321 Stainless Steel w/Hard Chrome	UHMW-PE	UHMW-PE	67372-CEF	B	637444-CED

* = Low Profile Solvent Cup

**Add "-1" to Model No. for Ball Valve Regulator

23:1 Pump Packages
on following page.

Recommended Accessories



67445-5
Muffler Kit



66334-B
Wet-Sol Packing Lu-
bricant



635043
ARO-Stop
Valve



67442
Ball Valve
Regulator



637489
Universal Air Motor
Service Kit

23:1 Ratio UV Ink Pump Packages



**TPX Series
Two Post Ram**

55
GALLON

Model No.	Package Type	Pump Model	Packages			
			Ram Model	Follower	Follower Description	Material
TP1223C51FF35TAC	55 Gallon Two Post Ram	AF1223C51FF35	RM552S-C	67409-6	Double Lip, Polyurethane	Aluminum w/PTFE Coating
TP1223C51FFP5AN2	55 Gallon Two Post Ram	AF1223C51FFP5	RM552S-C	67410-2	Double-Tube, EPR	Aluminum

Recommended Accessories



Low Level Cut-Off
67500 Used to shut off air supply to pump when material container is empty or near-empty



Inline Flow Control
104104-F06 Helps set and maintain precise operating speeds in order to optimize pump performance



Cross Over Kit
67448 Maintains fluid delivery in extrusion systems. Can activate alarm to alert maintenance to change empty fluid container

Other Accessories & Repair Kits

62274	Air Line Oil
96916	Standard Air Motor Muffler
66333-B	Wet-Sol (1 Quart)
66353-1	Stabilizing Bracket
637489	Universal Air Motor Service Kit
637491	55 Gallon Two Post Ram Repair Kit (Standard)
67480	55 Gallon Two Post Ram Cross Over Kit
67503	55 Gallon Drum Hold Down Kit

28:1

N
Series

NM2328A-11-X11 Series Pumps



Materials: Paint, Coatings

Pump Specifications

Ratio	28:1
Stroke in (mm)	3 (76)
Material Inlet	1/2" NPT(F)
Air Inlet (female)	1/4" NPT(F)
Air Inlet Pressure Range psi (bar)	0-150 (0-10.3)
Fluid Pressure Range psi (bar)	0-4,200 (0-289.7)
Max Cycles/Minute	125
Displacement/Cycle cu in (cm ³)	1.4 (22.9)
Cycles/gal (L)	157.5 (43.5)
Flow @ 60 Cycles gpm (L/min)	0.38 (1.4)
Noise Level @ 100 psi dBA	85
Weight* lb (kg)	13 (5.9)

Model	A in (mm)	B in (mm)	C in (mm)
NM2328A-11-X11	21.75 (552.1)	13.031 (331)	6.25 (158.6)

PERFORMANCE BASED ON 30wt. OIL (100 cSt) AT 40° C TEMPERATURE

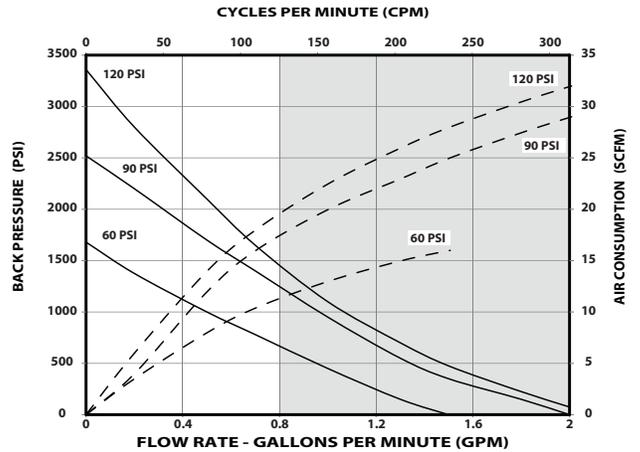

PERFORMANCE BASED ON 30wt. OIL (100 cSt) AT 40° C TEMPERATURE

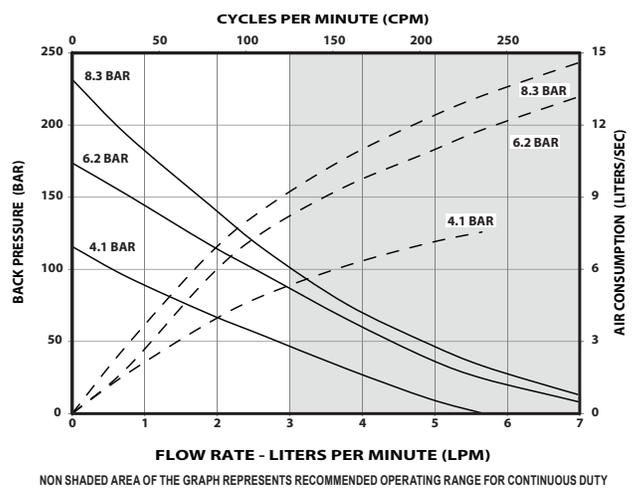

Pump Model	Lower Pump Material	Plunger Material	Upper Packings	Lower Packings	Material Outlet	Pump Service Kit*
Lower Pump Material - Stainless Steel						
NM2328A-11-311	440 Stainless Steel	440 Stainless Steel	PTFE	PTFE	.25" NPT(M)	637006-1
NM2328A-11-G11	440 Stainless Steel	440 Stainless Steel	UHMW-PE / Leather	UHMW-PE / Leather	1.25" NPT(M)	637006-2
NM2328A-11-S11	440 Stainless Steel	440 Stainless Steel	UHMW-PE	UHMW-PE	1.25" NPT(M)	637006-3

*Lower pump repair kit

Recommended Accessories



P29122-600
Piggyback
F/R

635040
ARO-Stop
Valve

61113
Wall Mount

66333-B
Wet Sol

651533
Airless Spray
Gun

637316
Air Motor
Service Kit

TC1550
Airless Spray
Nozzle

628042-25
Hose
Assembly

28:1

8"

AFX
Series

AF0828 Series Pumps



(Model shown w/ ball valve regulator)

Materials: Oils, Paint, Coatings, Chemicals**Pump Specifications**

Ratio	28:1
Stroke (double acting)	6" (15.24 cm)
Material Inlet	2" NPT(F)
Material Outlet	1" NPT (F)
Air Inlet (female)	3/4" NPT(F)
Air Inlet Pressure Range psi (bar)	30 - 120 (2.1 - 8.3)
Fluid Pressure Range psi (bar)	840 - 3360 (57.9 - 231.7)
Max Cycles/Minute	60
Displacement/Cycle cu in (cm ³)	20.7 (338.65)
Cycles/gal (L)	11.2 (42.34)
Flow @ 60 Cycles gpm (L/min)	5.38 (20.4)
Noise Level @ 60 psi dBA	86.8
Weight* lb (kg)	126 (57.2)
Container Suitability	Remote Mounting

*Estimated weight. Contact Technical Support for exact weight.

DIMENSIONS

A ¹ in (mm)	50.24 (1276.15)
B in (mm)	27.19 (690.58)
C in (mm)	16.13 (409.7)

¹For models without ball valve regulator subtract 2.08 in (52.83 mm)

PERFORMANCE BASED ON 30wt. OIL (100 cSt) AT 40° C TEMPERATURE

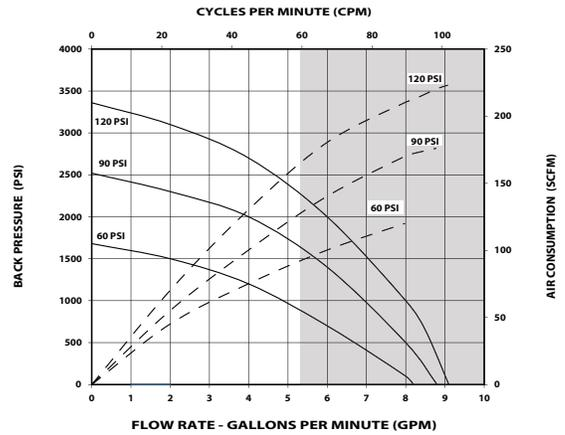

NON SHADED AREA OF THE GRAPH REPRESENTS RECOMMENDED OPERATING RANGE FOR CONTINUOUS DUTY

PERFORMANCE BASED ON 30wt. OIL (100 cSt) AT 40° C TEMPERATURE

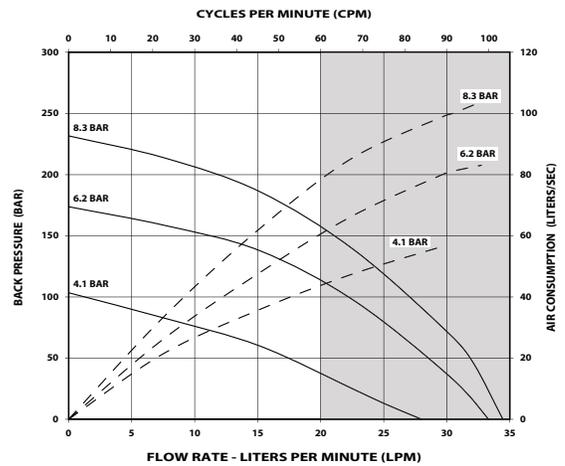

NON SHADED AREA OF THE GRAPH REPRESENTS RECOMMENDED OPERATING RANGE FOR CONTINUOUS DUTY

Pump Model**	Plunger Material	Upper Packings	Lower Packings	Lower Pump Model	Pump Service Kit
Lower Pump Material -Stainless Steel					
AF0828G11RK47	17-4 Stainless Steel w/Hard Chrome	Glass Filled PTFE/ UHMW-PE (Staggered)	Glass Filled PTFE	2094G11RK47	K2094G11RK47
AF0828G11HH47	17-4 Stainless Steel w/Hard Chrome	UHMW-PE /Leather Staggered	UHMW-PE / Leather Staggered	2094G11HH47	K2094G11HH47

**Add "-1" to Model No. for Ball Valve Regulator

Recommended Accessories67445-3
Muffler Kit66334-B
Wet-Sol Packing
Lubricant23644-400
ARO-Stop
Valve65139
Floor Mount67442
Ball Valve
Regulator

ServiceKits

637489
Universal Air Motor
Service Kit

30:1
4-1/4"

**AFX
Series**

AF0430 Series Pumps



(Model shown w/ball valve regulator)

Materials: Oils, Paint, Coatings, Chemicals

Pump Specifications

Ratio	30:1
Stroke (double acting)	6" (15.24 cm)
Material Inlet	1" NPT(F) 2" PTF SAE Short (M)
Material Outlet	1" NPT(F)
Air Inlet (female)	1/2" NPT(F)
Air Inlet Pressure Range psi (bar)	30 - 150 (2 - 10.3)
Fluid Pressure Range psi (bar)	900 - 4629 (62 - 319)
Max Cycles/Minute	60
Displacement/Cycle cu in (cm3)	5.5 (90.1)
Cycles/gal (L)	41.9 (11.0)
Flow @ 60 Cycles gpm (L/min)	1.3 (4.9)
Noise Level @ 60 psi dBA	86.5
Weight* lb (kg)	42.9 (19.5)
Container Suitability	Remote Mounting

*Estimated weight. Contact Technical Support for exact weight.

DIMENSIONS

A ¹ in (mm)	42.18 (1071.47)
B in (mm)	18.91 (480.34)
C in (mm)	12.66 (321.59)

¹For models without ball valve regulator subtract 2.08 in (52.83 mm)

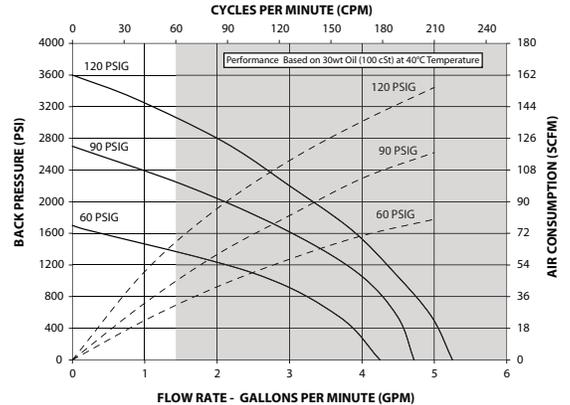

NON SHADED AREA OF THE GRAPH REPRESENTS RECOMMENDED OPERATING RANGE FOR CONTINUOUS DUTY

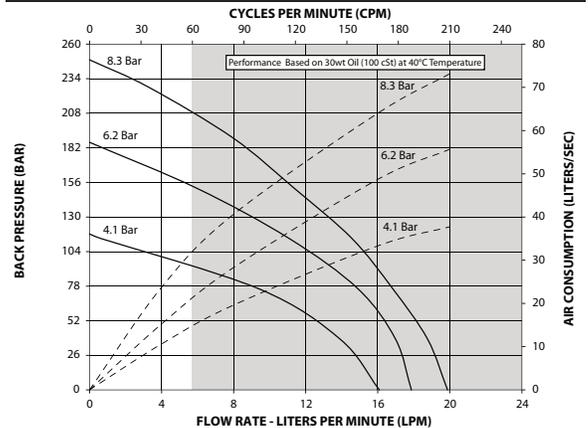

NON SHADED AREA OF THE GRAPH REPRESENTS RECOMMENDED OPERATING RANGE FOR CONTINUOUS DUTY

Pump Model**	Plunger Material	Upper Packings	Lower Packings	Lower Pump Model	Lower Pump Mounting Footprint	Pump Service Kit
Lower Pump Material - 300 Series SS w/ Tungsten Carbide Seat						
AF0430G11FF47	17-4 Stainless Steel w/Hard Chrome	UHMW-PE	UHMW-PE	66302-C43	D	637307-C43
AF0430G11KK47	17-4 Stainless Steel w/Hard Chrome	Glass Filled PTFE	Glass Filled PTFE	66302-343	D	637307-343
AF0430G11HH47	17-4 Stainless Steel w/Hard Chrome	UHMW-PE/Leather (Staggered)	UHMW-PE/Leather (Staggered)	66302-G43	D	637307-G43
AF0430G11GF47	17-4 Stainless Steel w/Hard Chrome	UHMW-PE/Glass Filled PTFE (Staggered)	UHMW-PE	66302-P43	D	637307-P43
AF0430G11GF48	17-4 Stainless, Ceramic Coated	UHMW-PE/Glass Filled PTFE (Staggered)	UHMW-PE	66302-P4B	D	637307-P43
AF0430G11HH48	17-4 Stainless, Ceramic Coated	UHMW-PE/Leather (Staggered)	UHMW-PE/Leather (Staggered)	66302-G4B	D	637307-G43

**Add "-1" to Model No. for Ball Valve Regulator

Recommended Accessories



67445-1
Muffler Kit



66334-B
Wet-Sol Packing
Lubricant



23644-400
ARO-Stop
Valve



67136
Floor/Follower
Plate Adapter



67442
Ball Valve
Regulator



637489
Universal Air Motor
Service Kit

**AFX
Series**

30:1 Ratio Pump Packages



CMX Series
Cart Mount

5
GALLON

Packages					
Model No.	Package Type	Pump Model	Cart Model	Material Hose	Material Filter
CM0430G11GF47001	Cart Mount	AF0430G11GF47-1	67139	67140-1	651422-70

Recommended Accessories



Airless Spray Guns

651533 Wetted parts of 316 stainless, 5,000 psi 1/4" NPS(M).
Used for light fluids. Order TC-XXXX airless spray tip separately.
651500-1 Wetted Parts Stainless Steel; 7500 psi, 3/8" NPTF Inlet.
For materials over 200,000 cPs. Order TC-XXXX for spray tips separately.



Airless Spray Tips

Typical spray orifices sizes (see accessory catalog for more options):
TC-1850: 0.018" (.46mm), **TC-2140:** 0.021" (.53mm), **TC-2640:** 0.026" (.66mm)



Swivel

636085 Straight, 3/8" (M) x 3/8" (F) / fabric with neoprene / 8,000 psi (552 bar) max. working pressure
636088 Z-360°, 3/8" (M) x 3/8" (F) / fabric with neoprene / 8,000 psi (552 bar) max. working pressure
75364 Straight, for use with 651533 gun / 1/4"-18 NPTF to 1/4"-18 NPSM / 10,000 psi (690 bar) max working pressure



Material Filters

1/2" F (2) inlet 1/2" F (1) outlet / 6,000 psi (414 bar) max. / 200 micron
651420-70 for Carbon Steel
651422-70 for Stainless Steel



3/8" Fluid Pressure Regulators

651780-A3A-B Regulated 400 – 1,250 psi (28 – 86 bar) / 3,000 psi (207 bar) max. inlet / stainless steel
651780-B1A-B Regulated 400 – 1,250 psi (28 – 86 bar) / 3,000 psi (207 bar) max. inlet / carbon steel
651780-B1B-B Regulated 1,000 – 3,000 psi (69 – 345 bar) / 6,000 psi (414 bar) max. inlet / carbon steel
651780-B3R-B Regulated 400 – 5,000 psi (28 – 345 bar) / 6,000 psi (414 bar) max. inlet / stainless steel

Other Accessories & Repair Kits

62274	Air Line Oil
96916	Standard Air Motor Muffler
66333-B	Wet-Sol (1 Quart)
F35341-400	Filter
104317	Filter Element
637489	Universal Air Motor Service Kit

40:1
8"

**AFX
Series**

AF0840 Series Pumps



(Model shown w/ball valve regulator)

Materials: Oils, Paint, Coatings, Chemicals

Pump Specifications

Ratio	40:1
Stroke (double acting)	6" (15.24 cm)
Material Inlet	1" NPT(F) 2" PTF SAE Short (M)
Material Outlet	1" NPT(F)
Air Inlet (female)	3/4" NPT(F)
Air Inlet Pressure Range psi (bar)	30 - 120 (2.1 - 8.3)
Fluid Pressure Range psi (bar)	1200 - 4967 (82.2 - 342.6)
Max Cycles/Minute	60
Displacement/Cycle cu in (cm3)	14.5 (237.6)
Cycles/gal (L)	16 (4.2)
Flow @ 60 Cycles gpm (L/min)	3.7 (14.0)
Noise Level @ 60 psi dBA	86.8
Weight* lb (kg)	68.1 (30.9)
Container Suitability	Remote Mounting

*Estimated weight. Contact Technical Support for exact weight.

DIMENSIONS

A ¹ in (mm)	45.65 (1159.43)
B in (mm)	22.59 (573.84)
C in (mm)	12.66 (321.59)

¹ For models without ball valve regulator subtract 2.08 in (52.83 mm)

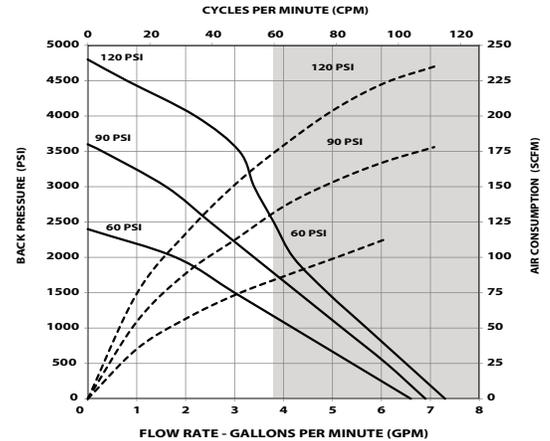

NON SHADED AREA OF THE GRAPH REPRESENTS RECOMMENDED OPERATING RANGE FOR CONTINUOUS DUTY

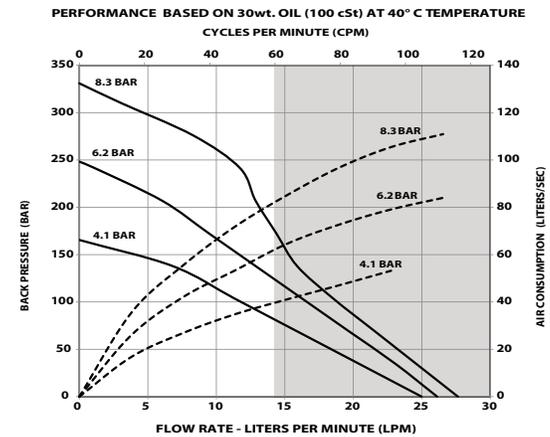

NON SHADED AREA OF THE GRAPH REPRESENTS RECOMMENDED OPERATING RANGE FOR CONTINUOUS DUTY

Pump Model**	Plunger Material	Upper Packings	Lower Packings	Lower Pump Model	Lower Pump Mounting Footprint	Pump Service Kit
Lower Pump Model Material – 300 Series SS w/ Tungsten Carbide Seat						
AF0840G11FF47	17-4 Stainless Steel w/Hard Chrome	UHMW-PE	UHMW-PE	66300-C4D	D	637305-C43
AF0840G11KK47	17-4 Stainless Steel w/Hard Chrome	Glass Filled PTFE	Glass Filled PTFE	66300-34D	D	637305-343
AF0840G11FF48	17-4 Stainless Steel, Ceramic Coated	UHMW-PE	UHMW-PE	66300-C4G	D	637305-C43
AF0840G11GF47	17-4 Stainless Steel w/Hard Chrome	UHMW-PE/Glass Filled PTFE (Staggered)	UHMW-PE	66300-P4D	D	637305-P43

**Add "-1" to Model No. for Ball Valve Regulator

Recommended Accessories

67445-3 Muffler Kit	66334-B Wet-Sol Packing Lubricant	23644-400 ARO-Stop Valve	67136 Floor/Follower Plate Adapter	67442 Ball Valve Regulator	637489 Universal Air Motor Service Kit

45:1

6"

AFX
Series

AF0645 Series Pumps



(Model shown w/ball valve regulator)

Materials: Oils, Paint, Coatings, Chemicals**Pump Specifications**

Ratio	45:1
Stroke (double acting)	6" (15.24 cm)
Material Inlet	1" NPT(F) 2" PTF SAE Short (M)
Material Outlet	1" NPT(F)
Air Inlet (female)	1/2" NPT(F)
Air Inlet Pressure Range psi (bar)	30 - 120 (2 - 8.3)
Fluid Pressure Range psi (bar)	1350 - 5459 (93 - 376)
Max Cycles/Minute	60
Displacement/Cycle cu in (cm ³)	7.5 (122.9)
Cycles/gal (L)	31 (8.1)
Flow @ 60 Cycles gpm (L/min)	1.9 (7.3)
Noise Level @ 60 psi dBA	84.8
Weight* lb (kg)	46.2 (21)
Container Suitability	Remote Mounting

*Estimated weight. Contact Technical Support for exact weight.

DIMENSIONS

A ¹ in (mm)	42.18 (1071.47)
B in (mm)	18.91 (480.34)
C in (mm)	12.66 (321.59)

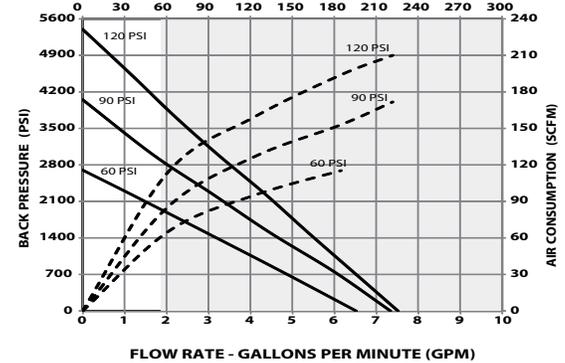
¹For models without ball valve regulator subtract 2.08 in (52.83 mm)**PERFORMANCE BASED ON 30wt. OIL (100 cSt) AT 40° C TEMPERATURE**
CYCLES PER MINUTE (CPM)

NON SHADED AREA OF THE GRAPH REPRESENTS RECOMMENDED OPERATING RANGE FOR CONTINUOUS DUTY :

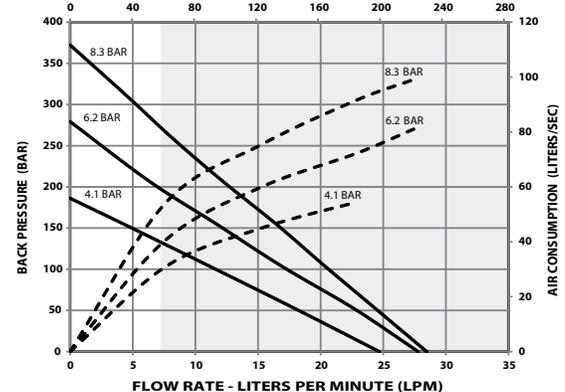
PERFORMANCE BASED ON 30wt. OIL (100 cSt) AT 40° C TEMPERATURE
CYCLES PER MINUTE (CPM)

NON SHADED AREA OF THE GRAPH REPRESENTS RECOMMENDED OPERATING RANGE FOR CONTINUOUS DUTY

Pump Model**	Plunger Material	Upper Packings	Lower Packings	Lower Pump Model	Lower Pump Mounting Footprint	Pump Service Kit
Lower Pump Material - 300 Series SS w/Tungsten Carbide Seat						
AF0645G11FF47	17-4 Stainless Steel w/Hard Chrome	UHMW-PE	UHMW-PE	66301-C43	D	637306-C43
AF0645G11KK47	17-4 Stainless Steel w/Hard Chrome	Glass Filled PTFE	Glass Filled PTFE	66301-343	D	637306-343
AF0645G11FF48	17-4 Stainless Steel, Ceramic Coated	UHMW-PE	UHMW-PE	66301-C4B	D	637306-C43
AF0645G11HH47	17-4 Stainless Steel w/Hard Chrome	UHMW-PE/Leather (Staggered)	UHMW-PE/Leather (Staggered)	66301-G43	D	637306-G43
AF0645G11GF47	17-4 Stainless Steel w/Hard Chrome	UHMW-PE/Glass Filled PTFE (Staggered)	UHMW-PE	66301-P43	D	637306-P43
AF0645G11RK47	17-4 Stainless Steel w/Hard Chrome	Glass Filled PTFE/UHMW-PE (Staggered)	Glass Filled PTFE	66301-R43	D	637306-R43
AF0645G11RK48	17-4 Stainless, Ceramic Coated	Glass Filled PTFE/UHMW-PE (Staggered)	Glass Filled PTFE	66301-R4B	D	637306-R43

**Add "-1" to Model No. for Ball Valve Regulator

45:1 Pump Packages on following page.

Recommended Accessories67445-2
Muffler Kit66334-B
Wet-Sol Packing
Lubricant23644-400
ARO-Stop
Valve67136
Floor/Follower
Plate Adapter67442
Ball Valve
Regulator637489
Universal Air Motor
Service Kit

45:1 Ratio Pump Packages



Packages						
Model No.	Package Type	Pump Model	Cart Model	Material Hose	Material Filter	Ball Valve Regulator
CM0645G11GF47001	Cart Mount	AF0645G11GF47-1	67139	67140-1	651422-70	67442

Model No.	Package Type	Pump Model	Ram Model	Follower	Follower Description	Material
TP0645G51RK47TN2	55 Gallon Two Post Ram	AF0645G11RK47	RM552S-C	67195-6	Double Tube, EPR	Aluminum w/PTFE Coating
TP0645G51RK47TB2	55 Gallon Two Post Ram	AF0645G11RK47	RM552S-C	66516-7	Double Lip, EPR	Aluminum w/PTFE Coating

Recommended Accessories



Airless Spray Guns

651533 Wetted parts of 316 stainless, 5,000 psi 1/4" NPS(M). Used for light fluids. Order TC-XXXX airless spray tip separately.
651500-1 Wetted Parts Stainless Steel; 7500 psi, 3/8" NPTF Inlet. For materials over 200,000 cPs. Order TC-XXXX for spray tips separately.



Airless Spray Tips

Typical spray orifices sizes (see accessory catalog for more options):
TC-1850: 0.018" (.46mm), **TC-2140:** 0.021" (.53mm), **TC-2640:** 0.026" (.66mm)



Swivel

636085 Straight, 3/8" (M) x 3/8" (F) / fabric with neoprene / 8,000 psi (552 bar) max. working pressure
636088 Z-360°, 3/8" (M) x 3/8" (F) / fabric with neoprene / 8,000 psi (552 bar) max. working pressure
75364 Straight, for use with 651533 gun / 1/4"-18 NPTF to 1/4"-18 NPSM / 10,000 psi (690 bar) max working pressure



Material Filters

1" F (2) inlet 3/8" F (3) outlet / 6,000 psi (414 bar) max. / Carbon Steel
651418-40-B for 40 Mesh (375 Microns)
651418-70-B for 70 Mesh (200 Microns)



3/4" Fluid Pressure Regulators

651780-C1B-B Regulated 750 – 2,500 psi (52 – 173 bar) / 6,000 psi (414 bar) max. inlet / carbon steel
651780-C1C-B Regulated 2,000 – 5,000 psi (138 – 345 bar) / 6,000 psi (414 bar) max. inlet / carbon steel
651780-C3B-B Regulated 750 – 5,000 psi (52 – 345 bar) / 6,000 psi (414 bar) max. inlet / stainless steel
651780-C3R-B Regulated 750 – 5,000 psi (52 – 345 bar) / 6,000 psi (414 bar) max. inlet / carbon steel

Other Accessories & Repair Kits

62274	Air Line Oil
96916	Standard Air Motor Muffler
66333-B	Wet-Sol (1 Quart)
66354-1	Stabilizing Bracket
637489	Universal Air Motor Service Kit
637491	55 Gallon Two Post Ram Repair Kit (RM552S-X)
67480	55 Gallon Two Post Ram Cross Over Kit
67500	Low-Level Cut-Off Kit
67503	55 Gallon Drum Hold Down Kit

45:1
10"

**AFX
Series**

AF1045 Series Pumps



(Model shown w/ball valve regulator)

Materials: Oils, Paint, Coatings, Chemicals

Pump Specifications

Ratio	45:1
Stroke (double acting)	6" (15.24 cm)
Material Inlet	2" NPT(F)
Material Outlet	1" NPT(F)
Air Inlet (female)	3/4" NPT(F)
Air Inlet Pressure Range psi (bar)	30 - 90 (2.1 - 6.2)
Fluid Pressure Range psi (bar)	1350 - 4050 (93.1 - 279.3)
Max Cycles/Minute	60
Displacement/Cycle cu in (cm3)	20.7 (339.2)
Cycles/gal (L)	11.2 (2.9)
Flow @ 60 Cycles gpm (L/min)	5.38 (20.4)
Noise Level @ 60 psi dBA	89.8
Weight* lb (kg)	141 (64)
Container Suitability	Remote Mounting

*Estimated weight. Contact Technical Support for exact weight.

DIMENSIONS

A ¹ in (mm)	50.24 (1276.15)
B in (mm)	27.19 (690.58)
C in (mm)	16.06 (408.00)

¹For models without ball valve regulator subtract 2.08 in (52.83 mm)

PERFORMANCE BASED ON 30wt. OIL (100 cSt) AT 40° C TEMPERATURE

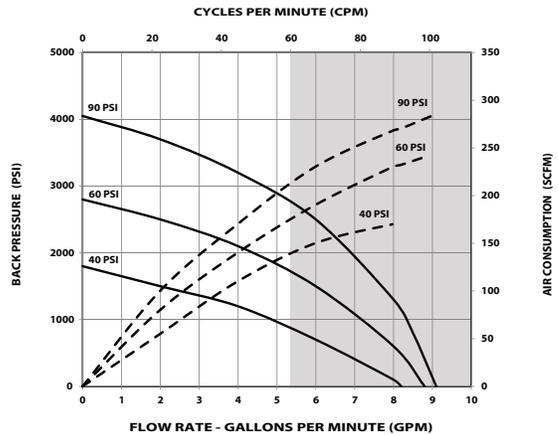

NON SHADED AREA OF THE GRAPH REPRESENTS RECOMMENDED OPERATING RANGE FOR CONTINUOUS DUTY

PERFORMANCE BASED ON 30wt. OIL (100 cSt) AT 40° C TEMPERATURE

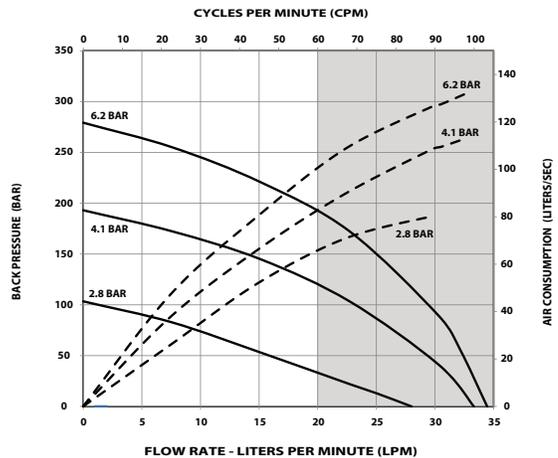

NON SHADED AREA OF THE GRAPH REPRESENTS RECOMMENDED OPERATING RANGE FOR CONTINUOUS DUTY

Pump Model**	Plunger Material	Upper Packings	Lower Packings	Lower Pump Model	Pump Service Kit
Lower Pump Model Material - Stainless Steel					
AF1045G11KK47	17-4 Stainless Steel w/Hard Chrome	Glass Filled PTFE	Glass Filled PTFE	2094G11KK47	K2094G11KK47
AF1045G11RK47	17-4 Stainless Steel w/Hard Chrome	Glass Filled PTFE/ UHMW-PE (Staggered)	Glass Filled PTFE	2094G11RK47	K2094G11RK47

**Add "-1" to Model No. for Ball Valve Regulator

Recommended Accessories



67445-4
Muffler Kit



66334-B
Wet-Sol Packing
Lubricant



635043
ARO-Stop
Valve



65139
Floor Mount



67442
Ball Valve
Regulator



637489
Universal Air Motor
Service Kit

60:1

6"

AFX
Series

AF0660 Series Pumps



(Model shown w/ball valve regulator)

Materials: Oils, Paint, Coatings, Chemicals**Pump Specifications**

Ratio	60:1
Stroke (double acting)	6" (15.24 cm)
Material Inlet	1" NPT(F) 2" PTF SAE Short (M)
Material Outlet	1" NPT(F)
Air Inlet (female)	1/2" NPT(F)
Air Inlet Pressure Range psi (bar)	30 - 100 (2 - 6.9)
Fluid Pressure Range psi (bar)	1800 - 6172 (124 - 426)
Max Cycles/Minute	60
Displacement/Cycle cu in (cm ³)	5.5 (90.1)
Cycles/gal (L)	41.9 (11)
Flow @ 60 Cycles gpm (L/min)	1.4 (5.4)
Noise Level @ 60 psi dBA	84.7
Weight* lb (kg)	46.2 (21)
Container Suitability	Remote Mounting

*Estimated weight. Contact Technical Support for exact weight.

DIMENSIONS

A ¹ in (mm)	42.18 (1071.47)
B in (mm)	18.91 (480.34)
C in (mm)	12.66 (321.59)

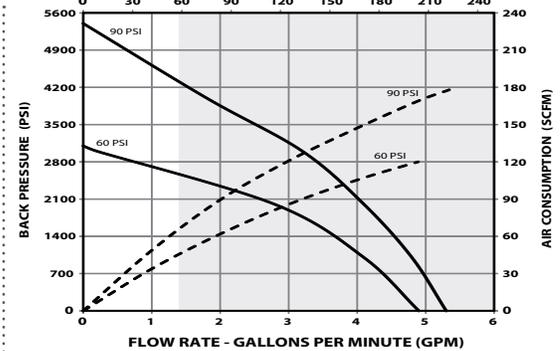
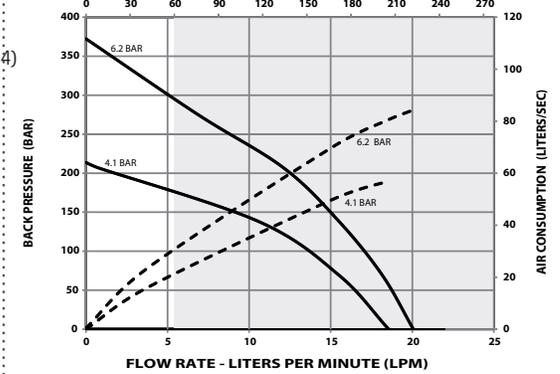
¹ For models without ball valve regulator subtract 2.08 in (52.83 mm)**PERFORMANCE BASED ON 30wt. OIL (100 cSt) AT 40° C TEMPERATURE**
CYCLES PER MINUTE (CPM)**PERFORMANCE BASED ON 30wt. OIL (100 cSt) AT 40° C TEMPERATURE**
CYCLES PER MINUTE (CPM)

Pump Model**	Plunger Material	Upper Packings	Lower Packings	Lower Pump Model	Lower Pump Mounting Footprint	Pump Service Kit
Lower Pump Material - 300 Series SS w/Tungsten Carbide Seat						
AF0660G11FF47	17-4 Stainless Steel w/Hard Chrome	UHMW-PE	UHMW-PE	66302-C43	D	637307-C43
AF0660G11KK47	17-4 Stainless Steel w/Hard Chrome	Glass Filled PTFE	Glass Filled PTFE	66302-343	D	637307-343
AF0660G11HH47	17-4 Stainless Steel w/Hard Chrome	UHMW-PE/Leather (Staggered)	UHMW-PE/Leather (Staggered)	66302-G43	D	637307-G43
AF0660G11RK47	17-4 Stainless Steel w/Hard Chrome	Glass Filled PTFE/UHMW-PE (Staggered)	Glass Filled PTFE	66302-R43	D	637307-R43
AF0660G11GF47	17-4 Stainless Steel w/Hard Chrome	UHMW-PE/Glass Filled PTFE (Staggered)	UHMW-PE	66302-P43	D	637307-P43
AF0660G11KK48	17-4 Stainless, Ceramic Coated	Glass Filled PTFE	Glass Filled PTFE	66302-34B	D	637307-343
AF0660G11FF48	17-4 Stainless, Ceramic Coated	UHMW-PE	UHMW-PE	66302-C4B	D	637307-C43

**Add "-1" to Model No. for Ball Valve Regulator

Recommended Accessories67445-2
Muffler Kit66334-B
Wet-Sol Packing
Lubricant23644-400
ARO-Stop
Valve67136
Floor/Follower
Plate Adapter67442
Ball Valve
Regulator**ServiceKits**637489
Universal Air Motor
Service Kit60:1 Pump Packages on
following page.

**AFX
Series**

60:1 Ratio Pump Packages



**CMX Series
Cart Mount**

5
GALLON

Packages						
Model No.	Package Type	Pump Model	Cart Model	Material Hose	Material Filter	Ball Valve Regulator
CM0660G11GF47001	Cart Mount	AF0660G11GF47-1	67139	67140-1	651422-70	67442

Recommended Accessories



Airless Spray Guns

651533 Wetted parts of 316 stainless, 5,000 psi 1/4" NPS(M). Used for light fluids. Order TC-XXXX airless spray tip separately.
651500-1 Wetted Parts Stainless Steel; 7500 psi, 3/8" NPTF Inlet. For materials over 200,000 cPs. Order TC-XXXX for spray tips separately.



Airless Spray Tips

Typical spray orifices sizes (see accessory catalog for more options):
TC-1850: 0.018" (.46mm), **TC-2140:** 0.021" (.53mm), **TC-2640:** 0.026" (.66mm)



Swivel

636085 Straight, 3/8" (M) x 3/8" (F) / fabric with neoprene / 8,000 psi (552 bar) max. working pressure
636088 Z-360°, 3/8" (M) x 3/8" (F) / fabric with neoprene / 8,000 psi (552 bar) max. working pressure
75364 Straight, for use with 651533 gun / 1/4"-18 NPTF to 1/4"-18 NPSM / 10,000 psi (690 bar) max working pressure



Material Filters

1" F (2) inlet 3/8" F (3) outlet / 6,000 psi (414 bar) max. / Carbon Steel
651418-40-B for 40 Mesh (375 Microns)
651418-70-B for 70 Mesh (200 Microns)



3/4" Fluid Pressure Regulators

651780-C1B-B Regulated 750 – 2,500 psi (52 – 173 bar) / 6,000 psi (414 bar) max. inlet / carbon steel
651780-C1C-B Regulated 2,000 – 5,000 psi (138 – 345 bar) / 6,000 psi (414 bar) max. inlet / carbon steel
651780-C3B-B Regulated 750 – 2,500 psi (52 – 173 bar) / 6,000 psi (414 bar) max. inlet / stainless steel
651780-C3R-B Regulated 750 – 5,000 psi (52 – 345 bar) / 6,000 psi (414 bar) max. inlet / stainless steel

Other Accessories & Repair Kits

62274	Air Line Oil
96916	Standard Air Motor Muffler
66333-B	Wet-Sol (1 Quart)
F35341-400	Filter
104317	Filter Element
637489	Universal Air Motor Service Kit

65:1

12"

AFX
Series

AF1265 Series Pumps

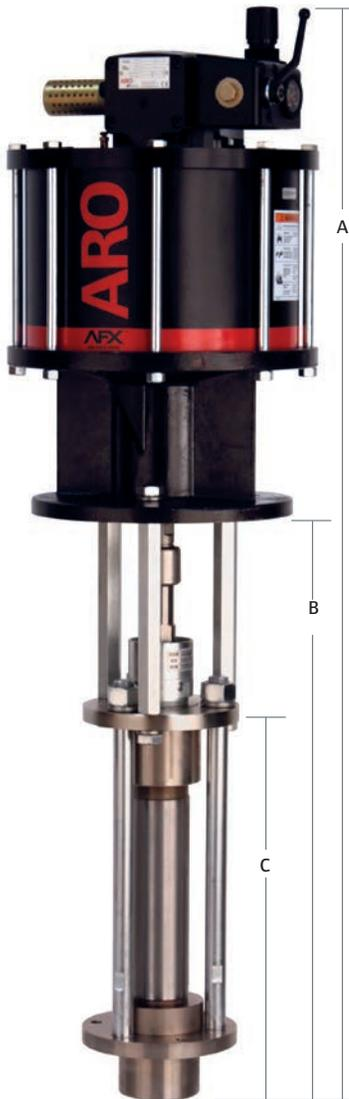

(Model shown w/ball valve regulator)

Materials: Oils, Paint, Coatings, Chemicals

Pump Specifications

Ratio	65:1
Stroke (double acting)	6" (15.24 cm)
Material Inlet	2" NPT(F)
Material Outlet	1" NPT(F)
Air Inlet (female)	3/4" NPT(F)
Air Inlet Pressure Range psi (bar)	30 - 90 (2.1 - 6.2)
Fluid Pressure Range psi (bar)	1950 - 5200 (134.5 - 358.5)
Max Cycles/Minute	60
Displacement/Cycle cu in (cm ³)	20.7 (339.2)
Cycles/gal (L)	11.2 (2.9)
Flow @ 60 Cycles gpm (L/min)	5.38 (20.4)
Noise Level @ 60 psi dBA	93
Weight* lb (kg)	147 (66.7)
Container Suitability	Remote Mounting

*Estimated weight. Contact Technical Support for exact weight.

DIMENSIONS

A ¹ in (mm)	50.27 (1276.91)
B in (mm)	27.19 (690.58)
C in (mm)	16.06 (408.00)

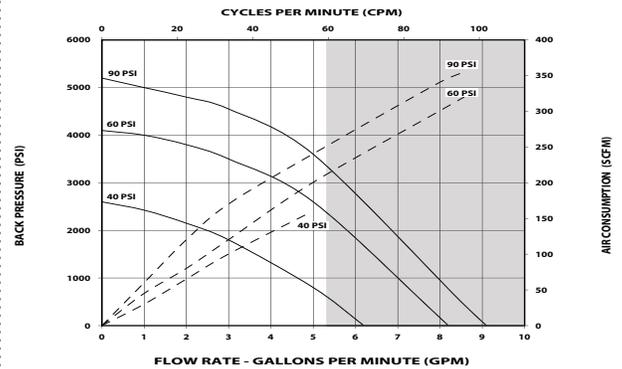
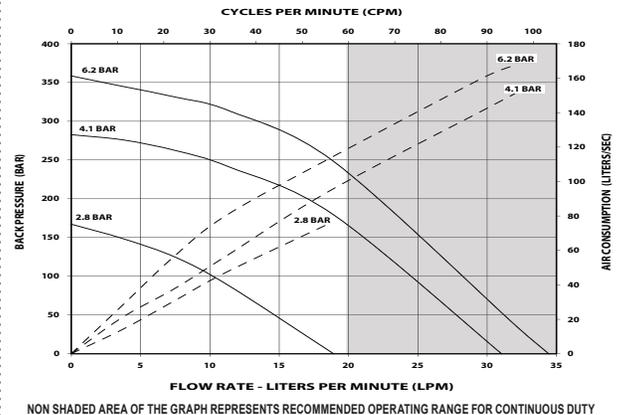
¹ For models without ball valve regulator subtract 2.08 in (52.83 mm)
PERFORMANCE BASED ON 30wt. OIL (100 cSt) AT 40° C TEMPERATURE

PERFORMANCE BASED ON 30wt. OIL (100 cSt) AT 40° C TEMPERATURE

Pump Model**	Plunger Material	Upper Packings	Lower Packings	Lower Pump Model	Pump Service Kit
Lower Pump Material - Stainless Steel					
AF1265G11HH47	17-4 Stainless Steel w/Hard Chrome	UHMW-PE/Leather (Staggered)	UHMW-PE/Leather (Staggered)	2094G11HH47	K2094G11HH47
AF1265G11RK47	17-4 Stainless Steel w/Hard Chrome	Glass Filled PTFE/ UHMW-PE (Staggered)	Glass Filled PTFE	2094G11RK47	K2094G11RK47

**Add "-1" to Model No. for Ball Valve Regulator

Recommended Accessories

67445-5
 Muffer Kit

66334-B
 Wet-Sol Packing
 Lubricant

635043
 ARO-Stop
 Valve

65139
 Floor/Follower
 Plate Adapter

67442
 Ball Valve
 Regulator

637489
 Universal Air Motor
 Service Kit

 65:1 Pump Packages on
 following page.

**AFX
Series**

65:1 Ratio Pump Packages



CMX Series
Cart Mount

BULK

Packages						
Model No.	Package Type	Pump Model	Cart Model	Material Hose	Material Filter	Material
CM1265G11HH47001	Cart Mount	AF1265G11HH47-1	66554-2	66728	651418-70-B	Aluminum w/PTFE Coating

Recommended Accessories



Airless Spray Guns

651533 Wetted parts of 316 stainless, 5,000 psi 1/4" NPS(M). Used for light fluids. Order TC-XXXX airless spray tip separately.
651500-1 Wetted Parts Stainless Steel; 7500 psi, 3/8" NPTF Inlet. For materials over 200,000 cPs. Order TC-XXXX for spray tips separately.



Airless Spray Tips

Typical spray orifices sizes (see accessory catalog for more options):
TC-1850: 0.018" (.46mm), **TC-2140:** 0.021" (.53mm), **TC-2640:** 0.026" (.66mm)



Swivel

636085 Straight, 3/8" (M) x 3/8" (F) / fabric with neoprene / 8,000 psi (552 bar) max. working pressure
636088 Z-360°, 3/8" (M) x 3/8" (F) / fabric with neoprene / 8,000 psi (552 bar) max. working pressure
75364 Straight, for use with 651533 gun / 1/4"-18 NPTF to 1/4"-18 NPSM / 10,000 psi (690 bar) max working pressure



Material Filters

1" F (2) inlet 3/8" F (3) outlet / 6,000 psi (414 bar) max. / Carbon Steel
651418-40-B for 40 Mesh (375 Microns)
651418-70-B for 70 Mesh (200 Microns)



3/4" Fluid Pressure Regulators

651780-C1B-B Regulated 750 – 2,500 psi (52 – 173 bar) psi / 6,000 psi (414 bar) max. inlet / carbon steel
651780-C1C-B Regulated 2,000 – 5,000 psi (138 – 345 bar) / 6,000 psi (414 bar) max. inlet / carbon steel
651780-C3B-B Regulated 750 – 2,500 psi (52 – 173 bar) / 6,000 psi (414 bar) max. inlet / stainless steel
651780-C3R-B Regulated 750 – 5,000 psi (52 – 345 bar) / 6,000 psi (414 bar) max. inlet / stainless steel

Other Accessories & Repair Kits

62274	Air Line Oil
96916	Standard Air Motor Muffler
66333-B	Wet-Sol (1 Quart)
F35341-400	Filter
104317	Filter Element
637489	Universal Air Motor Service Kit

CELEBRATING

50

YEARS OF EXPERIENCE

**EXPERIENCE INNOVATIVE
THINKERS AND PRODUCTS**



ALL ABOUT EXPERIENCE

allpumps.com.au

1300 255 786 | sales@allpumps.com.au