

SaniForce® Tote Unloader (STU)

3A5416L
EN

For use with food grade bulk supply of medium to high viscosity product. For professional use only. Only select models are approved for use in explosive atmospheres or hazardous locations. See Configuration Matrix on page 6 for more information.



Important Safety Instructions

Read all warnings and instructions in this manual and all related manuals. **Save all instructions.**

For Maximum Working Air and Fluid Pressures, see Models on page 8.

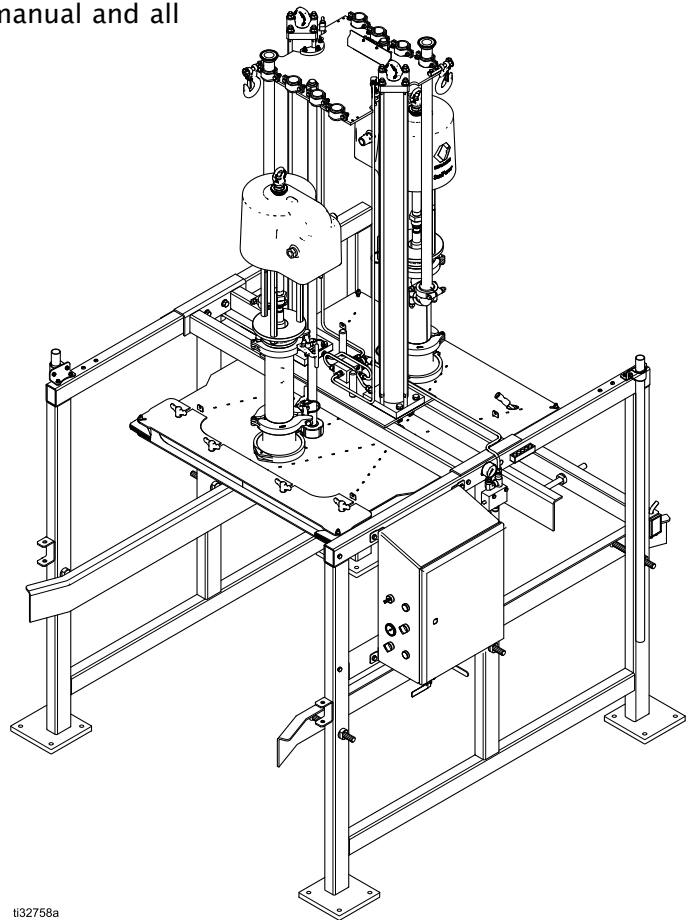

1132758a

Contents



Related Manuals	3	Change the Tote	29
Warnings	4	Emergency Stop	30
Configuration Matrix	7	Pump Shutdown	30
Models	8	System Shutdown	30
Overview	9	Flushing and Storage	30
System Components	9	Maintenance	31
Before Installing	11	Lubrication	31
Uncrate the Equipment	12	Cleaning the Ram Plate	31
Select a Location	13	Cleaning the Pump Lower	31
Move the Frame to the Selected Location	13	Electro-pneumatic Control Panel Display Screens	32
Installation	14	Startup Screen	34
General Information	14	Automatic Screen	35
Ground the System	14	Manual Screen	38
AC Power	15	Recipe Screens	40
Fluid Outlet Lines	15	Event Log	48
Safety Latch	16	Job Log	52
Install Lockout Extension	16	System Configuration Screen	54
Safety Latch Lockout	16	Feedback Control Screen	56
Engaging the Safety Latch	16	Network	59
Disengaging the Safety Latch	16	Ethernet/IP	60
Controls and Connections	17	About	66
Control Panel (Pneumatic)	17	I/O Status Screen	67
Control Panel (Electro-Pneumatic)	22	Import and Export with USB	68
Operation	24	Settings Parameters	68
Pressure Relief Procedure	25	Dimensions	72
Clean the Pump Before First Use	25	Wash Bin	72
Adjust Tote Guides	26	Schematic (pneumatic control)	74
Loading the Tote	26	Schematic (electo-pneumatic control)	75
Start and Adjust the Pump	28	Technical Data	80







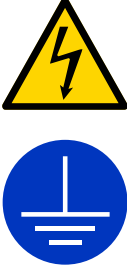

Related Manuals





Manual Number	Title
3A5417	SaniForce Sanitary Tote Unloader (STU), Repair
3A5798	SaniForce 5:1 Sanitary Pumps, Instructions and Parts
3A5799	SaniForce 12:1 Sanitary Pumps, Instructions and Parts
3A5999	SaniForce High Sanitation Diaphragm Pumps, Instructions and Parts
3A6781	SaniForce 1590 High Sanitation Diaphragm Pump, Repair and Parts
3A6779	SaniForce High Sanitation Diaphragm Pumps, Model 3250, Operation
3A6783	SaniForce High Sanitation Diaphragm Pumps, Model 3250, Repair and Parts
3A1211	SaniForce Air Motors, Instructions and Parts
3A6101	Enclosed Manual Controls, Repair/Parts
3A6102	Electro-pneumatic Controls, Instructions-Parts

Warnings

The following warnings are for the setup, use, grounding, maintenance, and repair of this equipment. The exclamation point symbol alerts you to a general warning and the hazard symbols refer to procedure-specific risks. When these symbols appear in the body of this manual or on warning labels, refer back to these Warnings. Product-specific hazard symbols and warnings not covered in this section may appear throughout the body of this manual where applicable.

 <h1 style="margin: 0;">WARNING</h1>	
	<p>ELECTRIC SHOCK HAZARD</p> <p>This equipment must be grounded. Improper grounding, setup, or usage of the system can cause electric shock.</p> <ul style="list-style-type: none"> • Turn off and remove power before disconnecting any cables and before servicing or installing equipment. For cart-mounted models, unplug the power cord. For all other units, disconnect power at the main switch. • Connect only to grounded power source. • All electrical wiring must be done by a qualified electrician and comply with all local codes and regulations.
	<p>FIRE AND EXPLOSION HAZARD</p> <p>Flammable fumes, such as solvent and paint fumes, in work area can ignite or explode. Paint or solvent flowing through the equipment can cause static sparking. To help prevent fire and explosion:</p> <ul style="list-style-type: none"> • Use equipment only in well ventilated area. • Eliminate all ignition sources; such as pilot lights, cigarettes, portable electric lamps, and plastic drop cloths (potential static sparking). • Ground all equipment in the work area. See Grounding instructions. • Keep work area free of debris, including solvent, rags and gasoline. • Do not plug or unplug power cords, or turn power or light switches on or off when flammable fumes are present. • Use only grounded hoses. • Stop operation immediately if static sparking occurs or you feel a shock. Do not use equipment until you identify and correct the problem. • Keep a working fire extinguisher in the work area. <p>Static charge may build up on plastic parts during cleaning and could discharge and ignite flammable vapors. To help prevent fire and explosion:</p> <ul style="list-style-type: none"> • Clean plastic parts only in well ventilated area. • Do not clean with a dry cloth.

 <h1 style="margin: 0;">WARNING</h1>	
    	<p>SKIN INJECTION HAZARD</p> <p>High-pressure fluid from dispensing device, hose leaks, or ruptured components will pierce skin. This may look like just a cut, but it is a serious injury that can result in amputation. Get immediate surgical treatment.</p> <ul style="list-style-type: none"> • Do not point dispensing device at anyone or at any part of the body. • Do not put your hand over the fluid outlet. • Do not stop or deflect leaks with your hand, body, glove, or rag. • Follow the Pressure Relief Procedure when you stop spraying/dispensing and before cleaning, checking, or servicing equipment. • Tighten all fluid connections before operating the equipment. • Check hoses and couplings daily. Replace worn or damaged parts immediately.
  	<p>MOVING PARTS HAZARD</p> <p>Moving parts can pinch or amputate fingers and other body parts.</p> <ul style="list-style-type: none"> • Keep clear of moving parts. • Do not operate equipment with protective guards or covers removed. • Pressurized equipment can start without warning. Before checking, moving, or servicing equipment, follow the Pressure Relief Procedure and disconnect all power sources.

 <h1 style="margin: 0;">WARNING</h1>	
 	<p>EQUIPMENT MISUSE HAZARD</p> <p>Misuse can cause death or serious injury.</p> <ul style="list-style-type: none"> • Do not operate the unit when fatigued or under the influence of drugs or alcohol. • Do not exceed the maximum working pressure or temperature rating of the lowest rated system component. See Technical Data in all equipment manuals. • Use fluids and solvents that are compatible with equipment wetted parts. See Technical Data in all equipment manuals. Read fluid and solvent manufacturer's warnings. For complete information about your material, request Safety Data Sheet (SDS) from distributor or retailer. • Turn off all equipment and follow the Pressure Relief Procedure when equipment is not in use. • Check equipment daily. Repair or replace worn or damaged parts immediately with genuine manufacturer's replacement parts only. • Do not alter or modify equipment. Alterations or modifications may void agency approvals and create safety hazards. • Make sure all equipment is rated and approved for the environment in which you are using it. • Use equipment only for its intended purpose. Call your distributor for information. • Route hoses and cables away from traffic areas, sharp edges, moving parts, and hot surfaces. • Do not kink or over bend hoses or use hoses to pull equipment. • Keep children and animals away from work area. • Comply with all applicable safety regulations.
	<p>TOXIC FLUID OR FUMES HAZARD</p> <p>Toxic fluids or fumes can cause serious injury or death if splashed in the eyes or on skin, inhaled, or swallowed.</p> <ul style="list-style-type: none"> • Read Safety Data Sheets (SDSs) to know the specific hazards of the fluids you are using. • Store hazardous fluid in approved containers, and dispose of it according to applicable guidelines.
	<p>PERSONAL PROTECTIVE EQUIPMENT</p> <p>Wear appropriate protective equipment when in the work area to help prevent serious injury, including eye injury, hearing loss, inhalation of toxic fumes, and burns. Protective equipment includes but is not limited to:</p> <ul style="list-style-type: none"> • Protective eyewear, and hearing protection. • Respirators, protective clothing, and gloves as recommended by the fluid and solvent manufacturer.

Configuration Matrix

Check the identification plate (ID) for the Configuration Number of your system. Use the following matrix to define the components of your system.

Sample Configuration Number: **STU A01AAA1AA1C21**

STU	A	01	A	A	A	1	AA	0	C21
Sanitary Tote Unloader	Frame	Pump	Plate Size (Bin Type)	Seal Type	Seal Material	Controls	Accessories	Wash Kit	Certification

NOTE: Some combinations are not possible. Please check with your local supplier.

Sanitary Tote Unloader	Frame		Pump			Plate Size (Bin Type)		Seal Type	
STU	A	Stainless Steel, Footed	01	5:1 Double Ball 2 pumps		A	44.375 x 40.375 (plywood)	A	Inflatable
	B	Stainless Steel, Extended Legs	02	5:1 Priming Piston 2 pumps		B	43.9 x 39.9 (Buckhorn 315) (Schoeller 315)	0	None
			03	12:1 Priming Piston, 2 pumps		C	55.5 x 42 (Goodpack)		
			04	5:1 Double Ball, 4 pumps		D	43.375 x 35.625 (TNT)		
			05	5:1 Priming Piston, 4 pumps		E	43.5 x 40.375 (Arena)		
			06	12:1 Priming Piston, 4 pumps		F	41.32 x 38.9 (Ceva/Pallecon)		
			07	3250 HS Ball Check, P.SSPTPO, AODD, 2 pumps		J	43.9 x 39.9 (Citadel)		
			12	3250 HS Ball Check, P.SSFKEO, AODD, 2 pumps		0	None		
			13	3250 HS Ball Check, P.SSPTPS, AODD, 2 pumps					
			14	3250 HS Ball Check, P.SSSPSP, AODD, 2 pumps					

Seal Material		Controls		Accessories		Wash Kit		Certification	
A	Polychloroprene (White)	1	Enclosed Pneumatic	AA	Bag Clamp Kit	0	None	C21	EN 10204 type 2.1
B	EPDM (Black)	2*	Electro-pneumatic	AB	Aceptic Liner Clamp Kit	1	Poly Tank Kit	C31	EN 10204 type 3.1
0	None								

* Not ATEX. Not intended for use in explosive or hazardous environments.

Models

Approvals

All models are rated:



and are FDA-compliant.

ATEX models with piston pumps are rated:



II 2 GD
Ex h IIA T4 Gb X
Ex h IIIB T100°C Db X

ATEX models with diaphragm pumps are rated:



II 2 GD
Ex h IIA 82°C...160°C Gb X
Ex h IIIB T135°C Db

Electro-pneumatic control panel component approval:



Intertek
9902741 Conforms to UL STD 508A
Certified to CSA STD C22.2 No. 14

Models

Pump Option	Max Pump Air Inlet Pressure PSI (MPa, bar)	Max Working Fluid Pressure PSI (MPa, bar)	Max System Air Consumption scfm (m ³ /min)	Max Control Air Inlet Pressure PSI (MPa, bar)
01	80 (0.55, 5.5)	410 (2.83, 28.3)	140 (3.9)	100 (0.69, 6.9)
02				
03	100 (0.69, 6.9)	1450 (10.0, 100)	240 (6.8)	
04	80 (0.55, 5.5)	410 (2.83, 28.3)	140 (3.9)	
05				
06	100 (0.69, 6.9)	1450 (10.0, 100)	240 (6.8)	
07	100 (0.69, 6.9)	100 (0.69, 6.9)	225 (6.3)	
12				
13				
14				

Overview

System Components

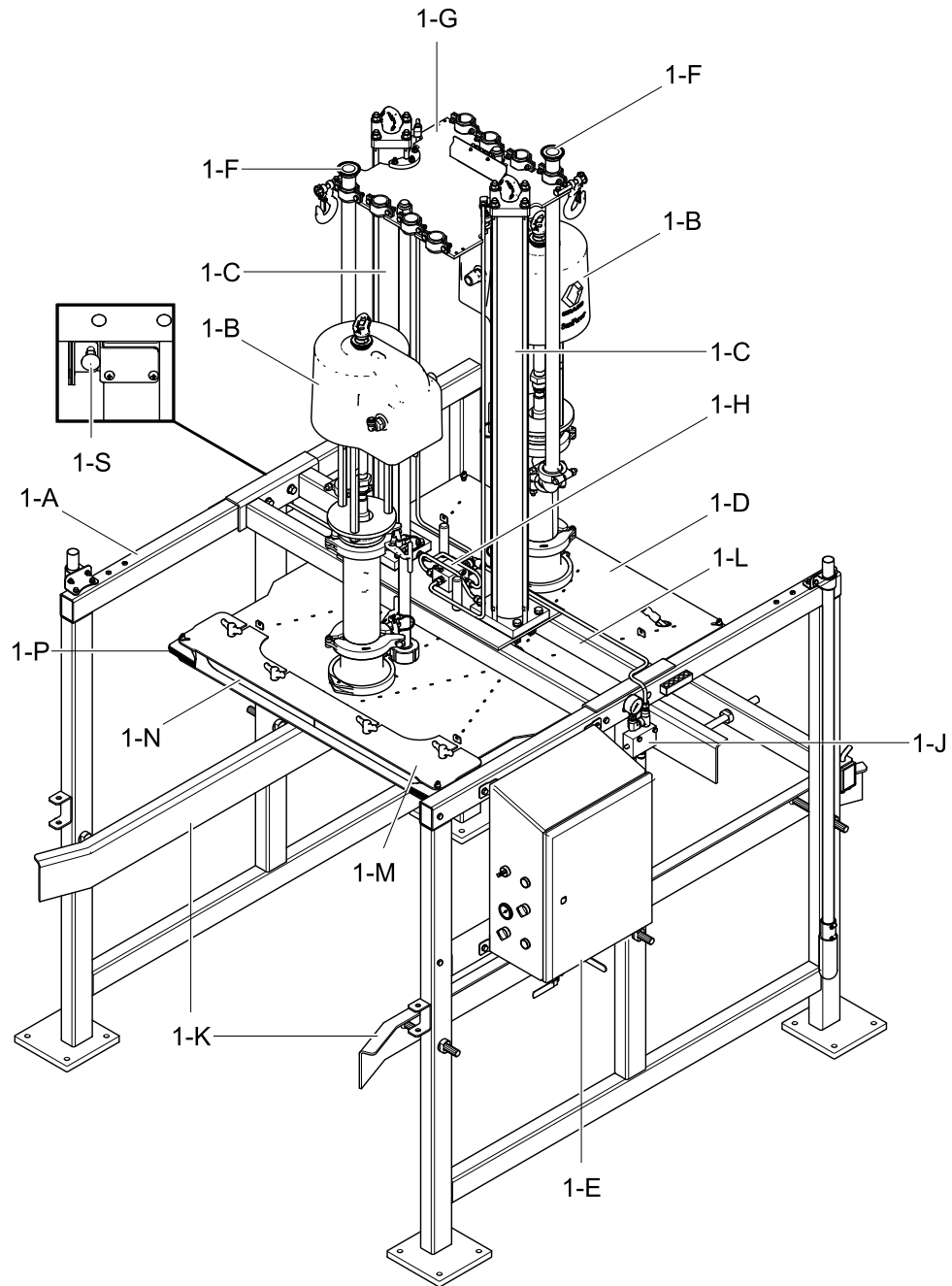

ti32762a

Fig. 1 Typical components

Overview

- 1-A **Stainless Steel Frame:** supports all of the system components.
- 1-B **Sanitary Pumps:** pump material from the tote to the target application.
- 1-C **Air Cylinders:** raises and lowers the pumps and the ram plate in and out of the material container.
- 1-D **Ram Plate:** applies an even amount of pressure to the material in the tote. When the ram plate seal is inflated, it creates a seal. The ram plate presses down on the material in the tote to assist the pumps in delivering the material.
- 1-E **Control Panel:** contains pneumatic controls to regulate the air pressure to pump air motors, ram, and ram plate seal in order to:
 - control pump air motor pressure
 - control pump speed control
 - control ram up and down pressure and speed
 - control seal pressure
- 1-F **Pump Output Lines:** delivers product output from pump.
- 1-G **Support Plate:** provides support for pump outlet tubes.
- 1-H **Rear Gate:** provides tote positioning and access.
- 1-J **Pilot Check Valve:** prevents unexpected cylinder movement.
- 1-K **Tote Guides:** provides alignment for tote.
- 1-M **Seal Retainer Plate:** keeps inflatable seal in place.
- 1-N **Inflatable Seal:** inflates to create a seal between the ram plate and inside surface of tote.
- 1-P **Corner Seal:** seals corners between ram plate and inside corner of tote.
- 1-R **Crossbar:** main structural support for cylinder/ram plate assemblies.
- 1-S **Safety Latch:** Engage to prevent accidental lowering of ram plate.

Before Installing

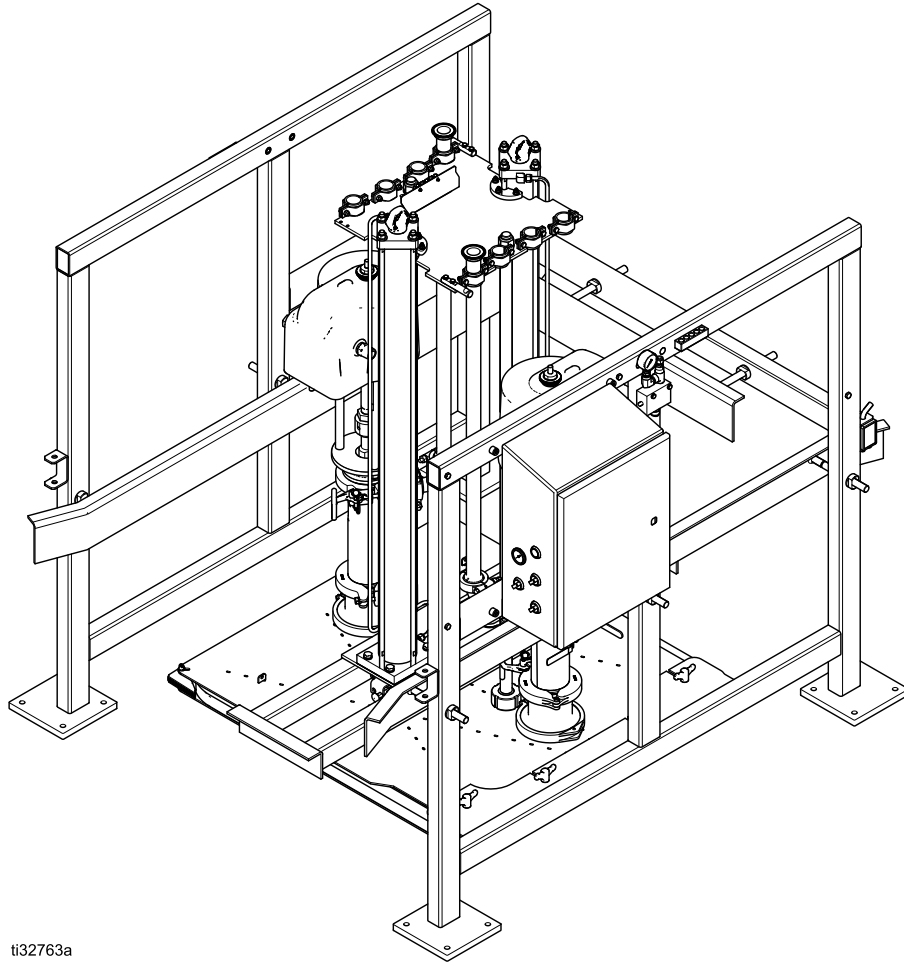

ti32763a

Palletized STU

Uncrate the Equipment

NOTICE

Moving the SaniForce STU off the pallet without following this uncrating procedure can damage equipment.

Uncrate the STU as follows:

1. Inspect the crate for shipping damage. Contact the carrier if damaged.
2. Remove plywood top and sides of crate.
3. Check the contents for loose or damaged parts.
4. Compare the packing slip against items inside the crate. Immediately call your Graco distributor about any shortages or damage.
5. Remove all band straps.
6. Remove the clevis pins holding the rear gate and remove the gate.
7. Remove the bolts holding the frame parts and move the frame parts to the installation location.

NOTE: Use sanitary anti-seize (provided) on all threaded joints to prevent galling.

NOTE: When installing, the crossbar (1-R) must be oriented with the safety latch bracket facing the leg assembly which doesn't contain the control panel. This orientation is also necessary to allow proper installation of the rigid air line from the pilot check valve (1-J) to the air manifold located on the crossbar between the air cylinders.

8. Install a provided PTFE gasket on top of each frame at the location where the crossbar will be mounted (FG). Use a forklift or overhead crane to move the air cylinder and pump assembly into place on the top of the frame assembly. Attach the crossbar to the leg assembly using the bolts provided.

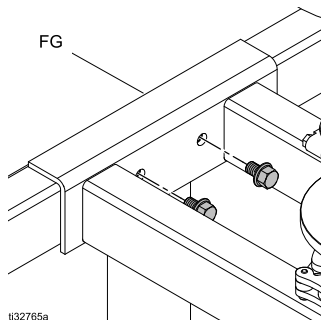

NOTE: Air pressure must be provided to raise the air cylinder center shafts enough to allow the safety latch to be disengaged. Do not force the safety latch to disengage. It may be necessary to install this safety latch extension rod at a later time.

9. Disengage the safety latch (1-S). On the leg assembly without the control box mounted on it, insert the end of the safety latch extension rod through the hole closest to the vertical center leg and then through the D-shaped hole on the safety latch. Install the locking nut on the safety latch extension rod.
 10. Install the rear gate and clevis pins on the frame.
 11. Attach the rigid air line between the cylinder air distribution manifold, down air pressure fitting (EE), and the pilot valve tee (EE1).
 12. Install each air motor exhaust hose to the top of the closest muffler tube.
 13. Attach independent air lines to the two control box inlet valves.
- NOTE:** Separate air inlets are provided to prevent loss of pneumatic valve control should pumps consume high volumes of air. Use independent air supplies.
14. Attach output tubing to the pump output piping.

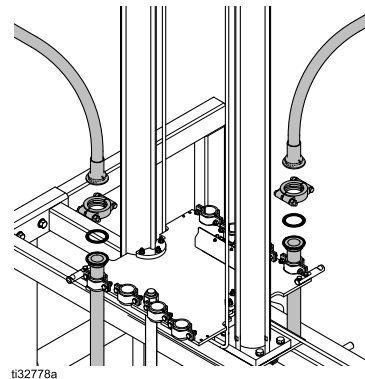



NOTE: Use only appropriate pressure-rated components.

Select a Location

When selecting a location for the STU assembly, make sure the location:



- Is close to where the fluid is being delivered to minimize back pressure and maximize flow rate.
- Provides enough room around the equipment for maintenance.
- Does not interfere with opening the control panel door or frame door (on one or both sides).
- Provides enough room on the right and/or left side of the SaniForce STU to easily load and unload fluid totes with a forklift or pallet jack hand truck.
- Provides easy and safe access to the air supply shutoff valves and the control panel. Graco recommends a minimum of 3 ft (0.91 m) of open space in front of the panel.
- Provides enough overhead clearance (10 ft, 2.7 m recommended) for installing and servicing the STU.
- Has a flat, level floor or level pads.

Move the Frame to the Selected Location

				
<p>The frame is shipped with several major components attached and weighs about 1500 lb (680 kg). To avoid injury and equipment damage, follow instructions below.</p> <p>The STU must be firmly attached to the floor. The STU is capable of exerting downward force of 2220 lbf (9.9 kN) which could cause the STU to lift off of the floor during operation.</p>				

- Use a forklift or hand truck and support devices, such as a hoist, and have an adequate number of personnel to move the frame to the installation site.
- Avoid jarring or tilting the frame while moving it.
- When the fully assembled unit has been moved to the installation location:
 - Mark the location of the mounting foot holes on the floor.
 - Move the frame out of position by rotating it to the side.
 - Drill anchor mounting holes and insert anchors at all marked foot hole locations.
 - Rotate the frame back into position and install frame mounting bolts through the frame feet.

Installation

				
All electrical wiring must be done by a qualified electrician and comply with all local codes and regulations.				



General Information

Reference letters in the text—for example, (A)—refer to the callouts in the figures.

The STU System consists of stationary parts and parts attached to the air cylinder center shafts. The parts, such as the pumps and plate, attached to the air cylinder center shafts will raise and lower (move) during normal operation. These moving parts comprise the ram.

Installation will involve attaching air lines between various system components. Refer to [Controls and Connections, page 17](#) for details regarding those air line connections from the control panel.

Ground the System

				
The equipment must be grounded to reduce the risk of static sparking and electrical shock. Electric or static sparking can cause fumes to ignite or explode. Improper grounding can cause electric shock. Grounding provides an escape wire for the electric current.				



Before operating the pump, ground the system as explained below.

- **Electro-pneumatic control panel:** If installed, it is grounded through the grounding conductor of the incoming power wiring.
- **Pump:** The pumps are grounded by the metal components being attached to the STU.
- **Air and fluid hoses:** Use only grounded hoses with a maximum of 500 ft (150 m) combined hose length to ensure grounding continuity. Check electrical resistance of hoses. If total resistance to ground exceeds 29 megohms, replace hose immediately.
- **Dispense valve:** ground through connection to a properly grounded fluid hose and pump.
- **Fluid supply container:** Follow local code.
- **Solvent containers used when flushing:** Follow local code. Use only conductive metal containers, placed on a grounded surface. Do not place the container on a non-conductive surface, such as paper or cardboard, which interrupts grounding continuity.
- **STU:** If using the electro-pneumatic control panel, the STU is grounded by the ground wire in the electrical connection to the panel. If using the pneumatic control panel, the user must attach a ground wire between the STU and earth ground. Ground wire 237686 is available separately.

Check your system electrical continuity after the initial installation, and then set up a regular schedule for checking continuity to be sure proper grounding is maintained. The resistance should not exceed 1 ohm.

AC Power

AC power is required for an unloader with an electro-pneumatic control panel.

				
All electrical wiring must be done by a qualified electrician and comply with all local codes and regulations.				

1. Route wires to the control panel through electrical conduit. Attach the conduit using the hole on the bottom right-hand side of enclosure with a type 4X rated conduit hub.
2. Attach the power system ground wire to the chassis ground lug (as shown) with a minimum 14 AWG (2.0 mm²) stranded copper wire. Torque to 35 in-lbs (3.95 N•m).

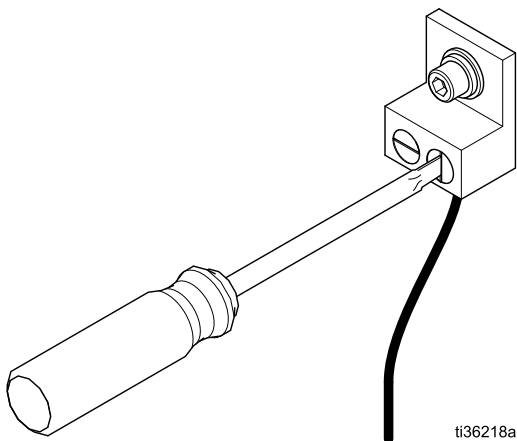

3. Connect the equipment to 100-240 VAC, single phase, 50/60 Hz, with a maximum 15 A branch circuit protection and disconnect switch provided by the installer. Use 14 AWG (2.0 mm²) stranded copper wire and attach to L1 and L2 on the power switch as shown. Torque to 8 in-lbs (0.9 N•m).

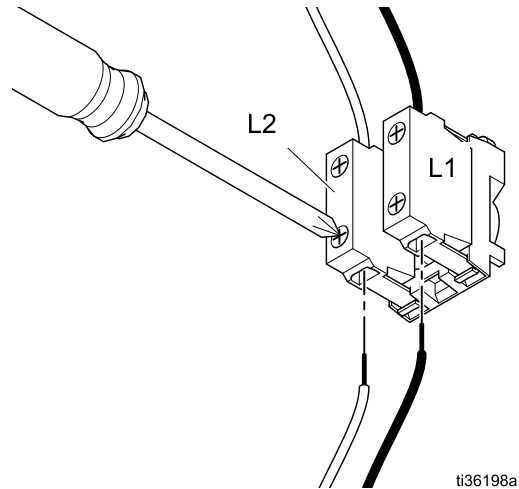



Fluid Outlet Lines

NOTICE

To prevent damage to equipment, be sure all components are adequately sized and pressure rated to meet the system's requirements. Refer to the pump manual for output pressure.

1. Connect desired pump outlet fittings (not supplied) to the fluid outlet port (1-F) of each pump.
2. Connect a grounded, flexible fluid hose (not supplied) to either the user-supplied fittings or the fluid outlet port (1-F).

Safety Latch

				
<p>The overall system weighs about 2400–3400 lb. (1089–1542 kg). To prevent being trapped under the ram plate, always set the manual safety latch to the Engage position when working under the plate.</p>				

Install Lockout Extension

A safety latch lockout extension rod (W) is provided for use on the safety latch. Installation of the extension rod requires the safety latch to be disengaged.

1. Disengage the safety latch. See **Disengaging the Safety Latch**.
2. Use the Ram Jog icon to lower the ram plate to its lowest position.
3. Follow the [Pressure Relief Procedure, page 25](#).
4. Insert the safety latch extension rod (W) through the bracket (X). With the polymer insert nut provided, attach the extension rod to the safety latch at the D-shaped hole on the latch.

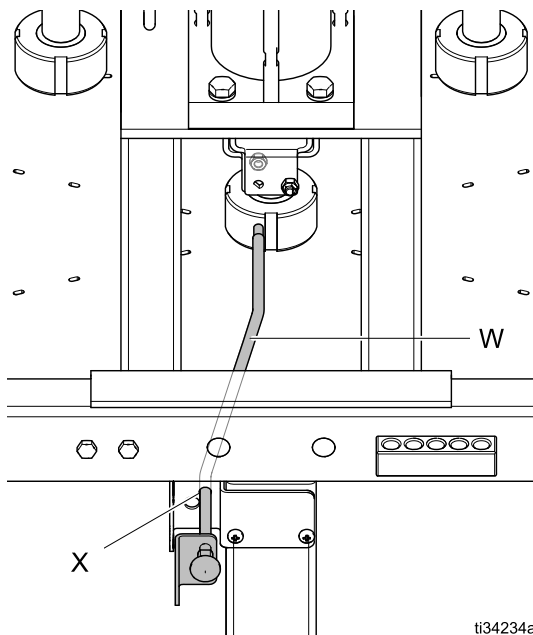

Safety Latch Lockout

Lockout/tagout holes have been provided to lock the ram in the raised position.

1. Push the safety latch handle all the way in to align the lockout/tagout holes (Y).
2. Insert a padlock through the hole and lock in place.

Engaging the Safety Latch

1. Using the ram position selector, raise ram until it stops at the maximum height.
NOTE: The safety latch must align with the grooves in the cylinder center rods to move.
2. Push the safety latch handle in the direction shown to engage with the groove in the cylinder rod (shown engaged).

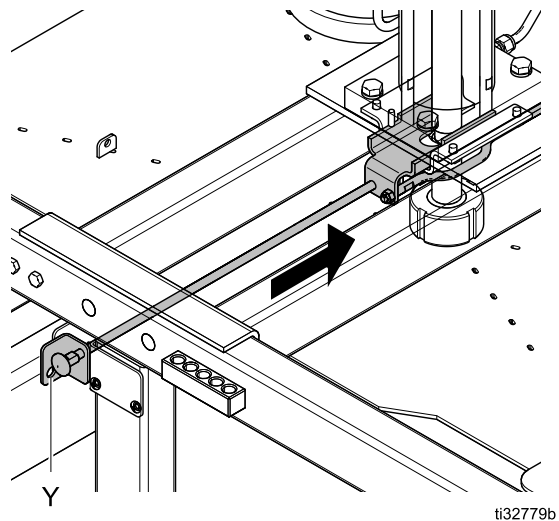

Disengaging the Safety Latch

1. Using the ram position control panel selector, make sure the plate is raised all the way up (not resting on the safety latch).
2. Pull the safety latch handle all the way out to disengage the groove in the cylinder rod.

Controls and Connections

Control Panel (Pneumatic)

Part No. 25C578

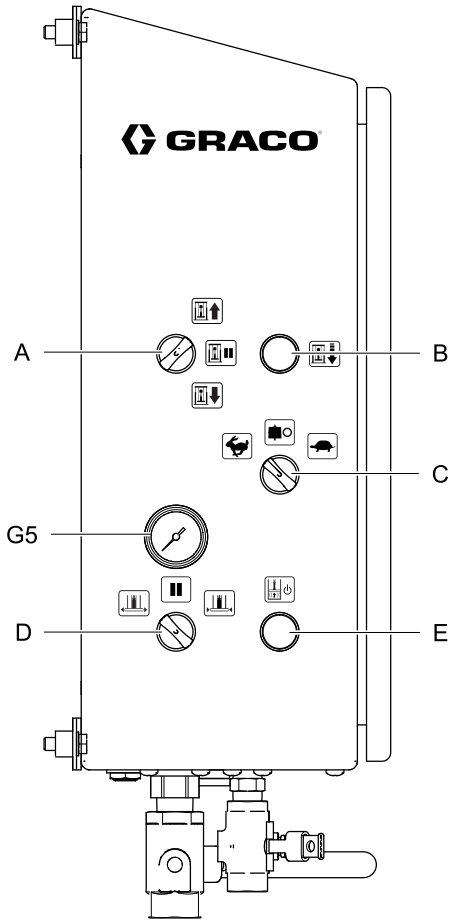

Control Side View

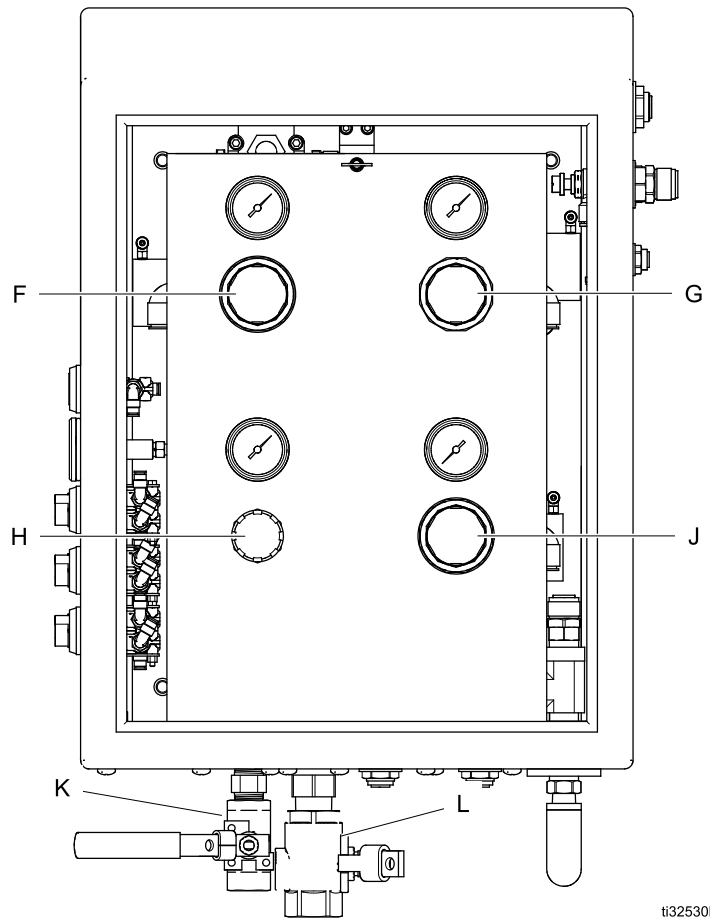

Component Panel

t132530b

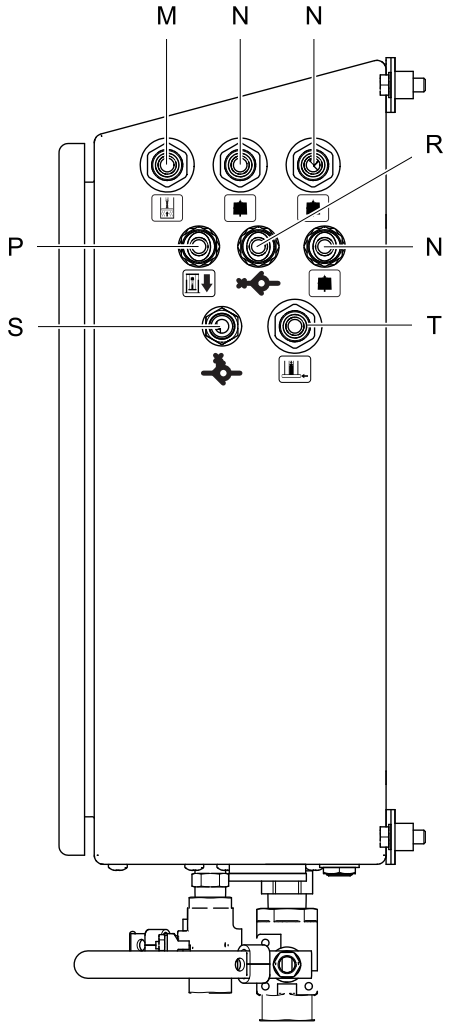

Connection Side View



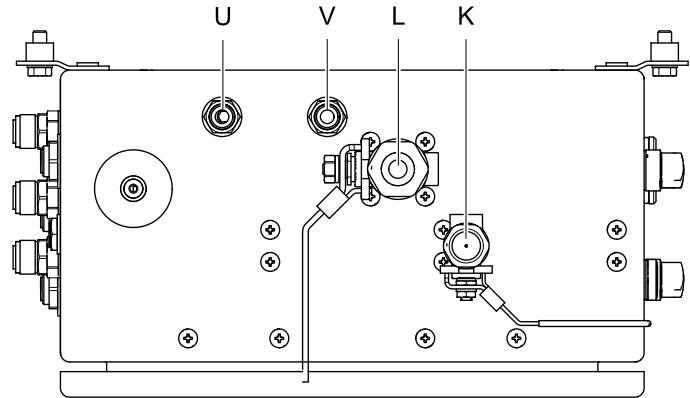







NOTE: When routing hoses for the air motor air supply, seal inflation, and air assist (blowoff) through the hose support bracket on the side of the frame, most of the lengths of each hose must be able to move freely above the hose









Bottom View

support bracket as the ram moves up and down. Select which hose support bracket hole to use for each specified hose by observing where that hose will travel during movement.

ti32529b

Ref.	Symbol	Description
Ram Position Selector:		
A		Ram Up Ram moves up. Up speed is regulated by flow control valve FC2. Up pressure is regulated by R4 (V).
		Ram Hold Holds ram at intermediate position.
		Ram Down Ram moves down and maintains force against top of product in tote. Down pressure is regulated by R3 (J). Down speed is regulated by flow control valve FC1.
B		Ram Jog While pressed, the ram will travel downward. Release the button to stop the ram travel.
Pump Speed Selector:		
C		Pump Fast Maximum air flow will be supplied to all pumps in the system.
		Pump Off Pumps will be turned off and all supply pressure will be dumped to atmosphere.
		Pump Slow Air flow to pumps is restricted to allow more effective priming. Pump slow speed can be adjusted using flow control valve FC5.
Seal Inflate Selector		
D		Seal Inflate Seal will inflate until the pressure set by regulator R1 (F) is reached. Pressure will be maintained until Seal Deflate is selected.
		Pause/Off Seal will hold current pressure. Venturi will be turned off.
		Seal Deflate Seal will deflate until empty. Venturi will aid deflation and will remain on. Venturi flow rate can be adjusted using flow control valve FC3.
E		Air Assist While pressed, will force air through the check valve (BB) to help unstick the ram plate from the bottom of the tote or tote liner.
F	----	Seal Regulator Controls the air pressure supplied to the inflatable seal.
G	----	Ram Up Regulator Controls the air pressure supplied to the cylinder for moving upward.
G5	----	Seal Pressure Gauge Indicates actual seal pressure.
H	----	Pump Regulator Controls the air pressure supplied to the pumps.

Ref.	Symbol	Description
J	— — — —	Ram Down Regulator Controls the air pressure supplied to the cylinders for moving downward.
K	— — — —	Control Panel Air Supply Ball Valve* Connect a clean, dry air supply to this valve for the controls. This valve will supply air to control valve pilots, air assist, and the inflatable seal. NOTE: It is recommended that the Control Panel Air Supply be separate from the Pump Air Supply to avoid the high air consumption of pumps from starving the control pilots. Use only clean, dry air.
L	— — — —	Pump Air Supply Ball Valve* Connect a clean, dry air supply to this valve for the pumps. See the specific pump instruction manual for minimum and maximum pressure and flow requirements. Use only clean, dry air.
M		Air Assist Port Route hose through the hose block on the side of the frame and through holes in the support plate to the check valve (B1) in the center of the ram plate. Use the provided 172-inch hose.
N		Pump Air Supply Ports (3 provided) Connect to supply air to pump manifold (FF) ports. Route hoses through the hose block on the side of the frame. Use the three provided 109-inch hoses. Connect the pump manifold (GG) ports to the pump air motors.
P		Cylinder Down Port Connect to the down pressure port (DD) on the cylinder distribution manifold on the top side of the crossbar.
R		Cylinder Up Port Connect 1/2 in. tube to the pilot check valve, V6-IN (R1) located on the side of the frame.
S		Pilot Signal Port Connect 3/8 in. tube to the pilot port (S1) on the pilot check valve (V6) located on the side of the frame.
T		Seal Inflation Port Route the hose through the hose block on the side of the frame and through holes in the support plate to the inflation tube (A1) of the inflatable seal. Use the provided 172-inch hose.
U	— — — —	Cylinder Exhaust Port Movement of the ram plate will exhaust return side of the ram cylinders through this port.
V	— — — —	Pump Pressure Dump Port Whenever pumps are stopped, the air supply pressure to the pump distribution manifold and the pump air inlets is dumped through this port.

** To avoid damage to the pneumatic control equipment caused by construction debris, dirt, and metal fragments, thoroughly clean out all air supply lines before connecting to this equipment.*

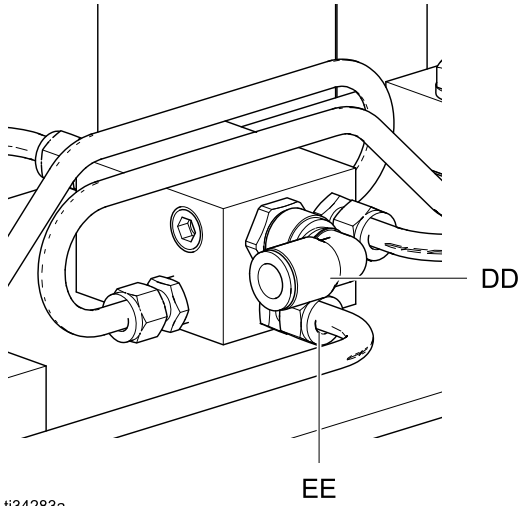

ti34283a

Cylinder air distribution manifold

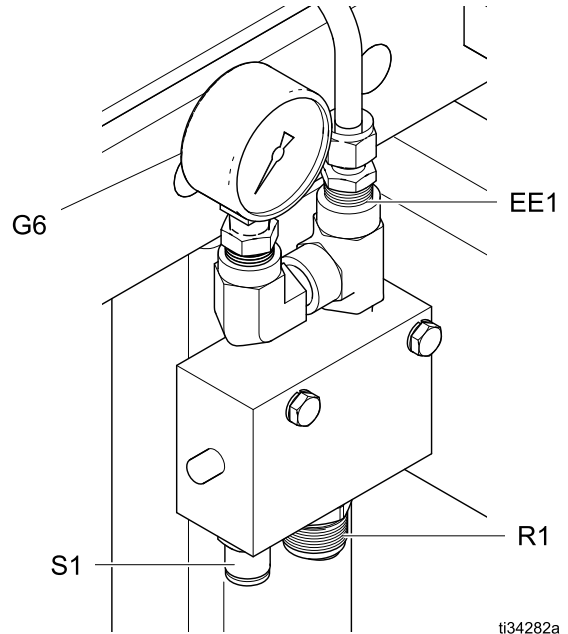

ti34282a

Pilot check valve

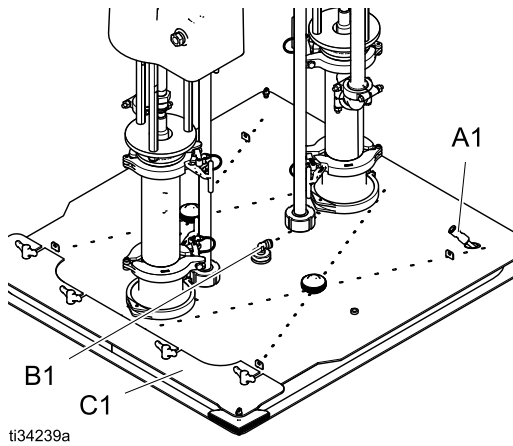

ti34239a

Ram plate

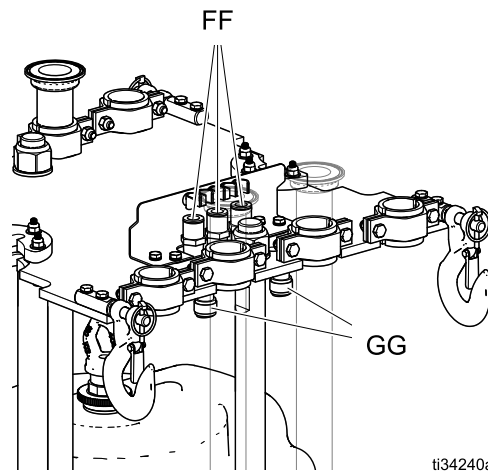

ti34240a

Support plate

Control Panel (Electro-Pneumatic)

Part No. 25D009





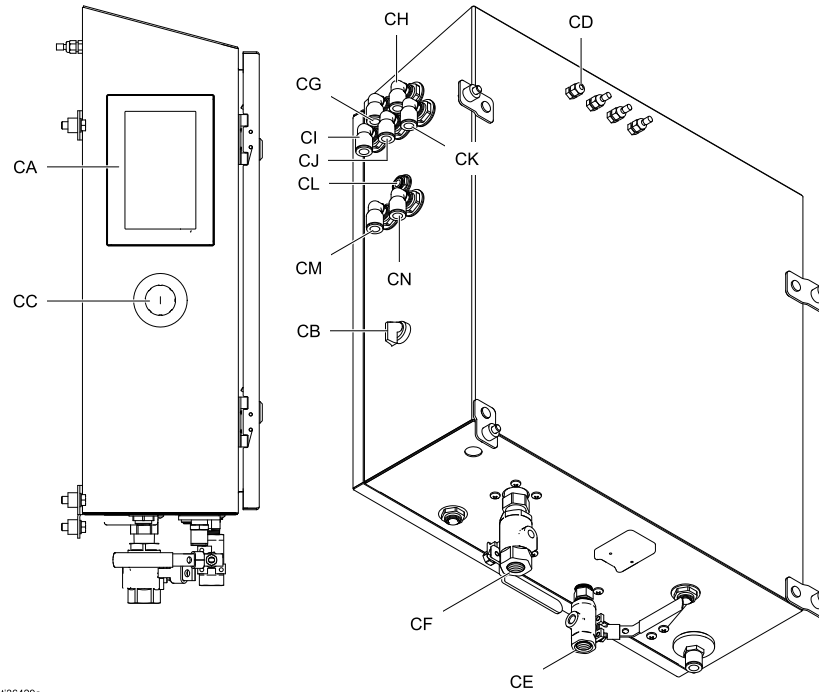

When supplied with 110–240 VAC power and a continuous supply of air, the control panel can control the STU functions for automatic, manual, or batch unloading of totes.

This panel is UL508A certified and requires using only Listed or Recognized components. Replacing parts with genuine Graco parts is important to maintain this certification. See the parts manual for replacement part numbers.



U96429a

Ref.	Symbol	Description
CA	— — —	Touch screen display Operator interface for control of the STU.
CB	— — —	AC power switch Controls whether power is applied to the control panel.
CC	— — —	Emergency stop button Press to cease STU operation immediately. This should not be used as a means to shut off the system during normal operation.
CD	— — —	Position sensor Access hole and sealed strain relief for the laser position sensor.
CE	— — —	Control Panel Air Supply Ball Valve Connect a clean, dry air supply to this valve for the control valve. This valve will supply air to control valve pilots, air assist, and the inflatable seal. NOTE: It is recommended that the Control Panel Air Supply be separate from the Pump Air Supply to avoid the high air consumption of pumps from starving the control pilots. Use only clean, dry air.
CF	— — —	Pump Air Supply Ball Valve Connect a clean, dry air supply to this valve for the pumps. See the specific pump instruction manual for minimum and maximum pressure and flow requirements. Use only clean, dry air.

Ref.	Symbol	Description
CG		Seal Inflation Port Route hose through the hose block on the side of the frame and through holes in the support plate to the inflation tube (A1) of the inflatable seal. Use the provided 172 inch hose
CH		Air Assist Port Route the hose through the hose block on the side of the frame and through holes in the support plate to the check valve (B1) in the center of the ram plate. Use the provided 172-inch hose.
CI		Pump Air Supply Ports (3 provided)
CJ		Connect supply air to pump manifold (FF) ports. Route hoses through the hose block on the side of the frame. Use the three provided 109-inch hoses. Connect the pump manifold (GG) ports to the pump air motors.
CK		
CL		Check valve pilot Connect 3/8 in. tube to the pilot port (S1) on the pilot check valve (V6) located on the side of the frame.
CM		Cylinder bottom Supply to the cylinder bottom. Connect 1/2 in. tube to the pilot check valve, V6-IN (R1) located on the side of the frame.
CN		Cylinder top Supply to the cylinder top. Connects to the cylinder distribution manifold on the crossbar.

Operation



Pressure Relief Procedure



Follow the Pressure Relief Procedure whenever you see this symbol.

This equipment stays pressurized until pressure is relieved manually. To help prevent serious injury from injection, splashing, or moving parts, follow the [Pressure Relief Procedure, page 25](#) when you stop pumping and before you clean, check, or service the equipment.

- c. Either raise the ram to the top position and engage safety latch (see [Engaging the Safety Latch, page 16](#)) or lower all the way down.
- d. Navigate to the [System Configuration Screen, page 54](#). Press the Shutdown/Depressurize icon. When pressed, a depressurizing pop-up screen appears. The user must acknowledge this screen to proceed.
- e. When the system has completed depressurizing, a pop-up screen will appear (will take up to 1 minute). The user must acknowledge this screen to proceed. Close the air supply valves (CE and CF).

Clean the Pump Before First Use

The pump should be cleaned prior to first use to remove any potential contaminants. See the pump manual for cleaning instructions.

1. For enclosed pneumatic control:

- a. Turn off pumps by moving the pump speed selector switch (C) to the Pause/Off (middle) position.
- b. Close the air supply valve (L) to the pumps.
- c. If used, open all user-supplied system fluid drain valves that are downstream of the pumps.
- d. Either raise the ram to the top position and engage safety latch (see [Engaging the Safety Latch, page 16](#)) or lower all the way down.
- e. Turn both the Ram Up Pressure Regulator (G) and Ram Down Pressure Regulator (J) to zero psi.
- f. Cycle the ram position selector (A) up and down until the gauge (G6) on the pilot check valve reads zero psi.
- g. Close the control panel supply valve (K).

2. For electro-pneumatic control:

- a. Stop evacuation activity.
- b. If used, open all user-supplied system fluid drain valves that are downstream of the pump.

Adjust Tote Guides

NOTE: The following steps require an empty tote.



- Seal burst may cause flying debris or product resulting in eye injury. Do not force fully inflated seal into the tote. Do not inflate the seal when not installed on the ram plate. Wear safety glasses when operating the system.
- The ram plate or the pump inlet can pinch fingers, resulting in serious injury. Keep hands and fingers away from the rim of the tote when raising or lowering the ram. Keep fingers away from the pump inlet.

1. Raise the ram to the highest position.
2. Position an empty tote under the ram plate.
3. Using Ram Jog, slowly lower the ram plate to a point just above the opening in the top of the tote. Position the empty tote within the leg assembly for accurate ram plate alignment with the tote.
4. If necessary, loosen the nuts and adjust the tote guides to the desired position for the tote. Tighten the nuts on the guides.

Loading the Tote

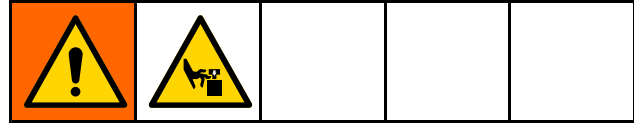

NOTICE

To prevent seal damage:

- Inflate the seal only after the ram plate has been lowered into the tote opening. Attempting to lower a ram plate with an inflated seal can damage the seal.
- Inflating the seal should only occur when the seal is properly installed on the ram plate with corner stops in place. When inflating the seal, do not exceed 15 psi.

1. At the pneumatic control panel:
 - a. Open the air shutoff valves for the air controls (K) and pumps (L).
 - b. On the control panel, move the Ram Position Selector (A) to the Ram Up position. If the ram does not elevate, increase the ram up air regulator (G) pressure on the component panel.

- c. Move the tote in front of the frame.
 - d. Remove the lid from the fluid tote to expose the fluid bag. If present, open the outer plastic bag and pull it up over the sides of the tote, exposing the aseptic inner bag.
 - e. Make sure the bag is taut and secure it in place. Install the provided bag clamps.
 - f. Load the tote of material into the center of the frame. Center the tote with the ram plate.
 - g. **Initial Setup Only:** The frame has guides to locate the tote. Adjust the guides (see [Adjust Tote Guides, page 26](#)) to center the tote under the ram plate. Leave enough space between guides and tote to allow for removal of the tote.
 - h. Move the Ram Position Selector (A) to the Ram Down position.
 - i. Ensure that the ram plate is centered inside the tote. Be careful not to pinch the inflatable seal when it enters the tote.
2. At the electro-pneumatic control panel:
 - a. Open the air shutoff valves for the air controls (CE) and pumps (CF).
 - b. Navigate to the Manual Run screen. Raise the ram to its highest point and engage the safety latch.
 - c. Move the tote in front of the frame.
 - d. Remove the lid from the fluid tote to expose the fluid bag. If present, open the outer plastic bag and pull it up over the sides of the tote, exposing the aseptic inner bag.
 - e. Make sure the bag is taut and secure it in place. Install the provided bag clamps.
 - f. Load the tote of material into the center of the frame. Center the tote with the ram plate.
 - g. **Initial Setup Only:** The frame has guides to locate the tote. Adjust the guides (see [Adjust Tote Guides, page 26](#)) to center the tote under the ram plate. Leave enough space between guides and tote to allow for removal of the tote.
 - h. Release the safety latch and jog the ram to lower to the tote.
 - i. Ensure that the ram plate is centered inside the tote. Be careful not to pinch the inflatable seal when it enters the tote.

Start and Adjust the Pump



Keep hands and fingers away from the ram plate, pump fluid inlet, and lip of the fluid container when raising or lowering the ram to reduce risk of serious injury from moving parts.

NOTICE

To prevent pinching or damaging the seal during tote insertion, only inflate the seal when the top lip of the ram plate is at, or below, the top edge of the tote.
To prevent the seal from restricting smooth movement of the ram plate within the tote, only inflate the seal until it makes contact around the perimeter of the tote.

1. For Enclosed Pneumatic Control Panel:

- a. Connect pump outlet fittings and hose (not supplied).

NOTE: Be sure all components are adequately sized and pressure rated to meet the system's requirements.

- b. Using the ram position control switch, lower the ram plate into the tote until it contacts the product in the tote.
- c. If the system is equipped with an inflatable seal and the ram plate is located far enough into the tote to properly inflate the seal, inflate it now. If the ram plate is not far enough into the tote for seal inflation, wait until enough product has been evacuated to lower the level of the ram plate in the tote before inflating.
- d. Move the air motor control switch to the run position. Observe that the pump begins to operate. Adjust air motor air pressure as needed.
- e. Move the ram position control switch to the down position. Observe that the ram lowers as product is evacuated. Adjust ram air pressure as needed.
- f. If using an inflatable seal and it has not yet been inflated and the ram plate has lowered far enough into the tote, inflate it now.
- g. Using the pressure settings for the various functions, fine-tune the pressures as needed.

NOTE: Increase air pressure to the ram if the pump does not prime properly with heavier fluids. Decrease air pressure if material is forced out around the inflatable seal.

2. For Electro-pneumatic Control Panel:

- a. Connect pump outlet fittings and hose (not supplied).
NOTE: Be sure all components are adequately sized and pressure rated to meet the system's requirements.
- b. Be sure the pump is set to pause. Set the ram down air pressure to 10 psi (0.06 MPa, 0.6 bar).

- c. Touch ram jog icon and lower the ram until it just contacts the product.
- d. If the ram plate is inside the tote, inflate the seal.

NOTE: To prevent damage to the seal, use the lowest seal pressure that still allows the seal to contact the inside surfaces of the tote.

- e. Start the pump at the slow (turtle) speed setting until the pump is primed. If necessary, adjust the pump pressure.
- f. Press the Ram Down icon.
- g. Using the pressure settings for the various functions, fine-tune the pressures as needed.

NOTE: Increase air pressure to the ram if the pump does not prime properly with heavier fluids. Decrease air pressure if material is forced out around the inflatable seal.



- c. If the ram raises the tote off of the ground, press the air assist (blowoff) button to break the vacuum between the ram plate and product.
- d. If the ram does not raise, increase the Ram Up Pressure.
- e. When the ram plate is free of the tote and the ram reaches its full height, operate the ram selector to the Ram Hold position.

3. Remove the empty tote.

				
To reduce the risk of injury, including pinching fingers, while cleaning material from the ram plate, relieve pump pressure before using tools to clean. Follow the Pressure Relief Procedure, page 25 .				

- 4. Inspect the ram plate and, if necessary, remove any remaining material or material build-up.
 - a. If used, open all user-supplied system fluid drain valves that are downstream of the pumps.
 - b. Use a tool to remove material build-up.
- 5. To empty another tote, perform the steps of [Loading the Tote, page 26](#).

Change the Tote

				
Excessive air pressure in the tote could cause the tote to rupture, resulting in serious injury. The ram must be free to move out of the tote. Never use blowoff air while the ram seal is inflated.				

- 1. Operate the pump speed selector to Off.
- 2. Raise the ram out of the tote:
 - a. Operate the seal selector to Deflate. Once the seal is deflated, operate the seal selector switch to Pause/Off.
 - b. Raise the ram out of the tote.

NOTE: The blowoff air comes directly from the unfiltered facility air supply.

Emergency Stop

Manual control systems do not have this feature.

The STU electro-pneumatic control box has an emergency stop button (CC) below the display screen. Pressing the emergency stop button will stop the pump but does not depressurize the system. Resetting the emergency stop places the system in a ready state. The system must be restarted by the operator. Restarting the pump will start in slow mode for a period of time and then switch to fast mode.

To reset the emergency stop button, rotate the knob in a clockwise direction until a click is heard or felt.

Do not use the emergency stop button to stop the system during normal operation.

Pump Shutdown

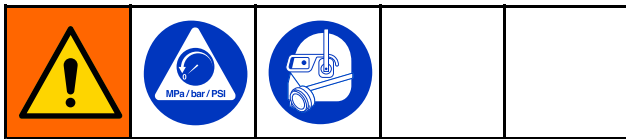

At the end of the work shift and before you check, adjust, clean, or repair the system, follow the [Pressure Relief Procedure, page 25](#).

System Shutdown

Follow the [Pressure Relief Procedure, page 25](#).

Depending on the type of material, it may be best to deflate the seal and raise the ram plate out of the material or keep the ram plate lowered in the bin. Some materials dry and harden when exposed to air. Cover materials when they are not being used.

Flushing and Storage

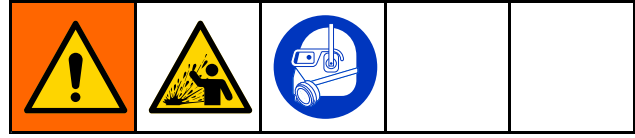

- Flush before fluid can dry in the equipment, at the end of the day, before storing, and before repairing equipment.
- Flush at the lowest pressure possible. Check connectors for leaks and tighten as necessary.
- Flush with a fluid that is compatible with the fluid being dispensed and the equipment wetted parts.
- Always flush the pump and relieve the pressure before storing it for any length of time.
- For long-term storage, thoroughly clean and dry pump and platen parts.

NOTICE

Flush the pump often enough to prevent the fluid you are pumping from drying or freezing in the pump and damaging it. Store the pump at 32°F (0°C) or higher. Exposure to extreme low temperatures may result in damage to plastic parts.

Maintenance

Lubrication

The pump is lubricated at the factory. It is designed to require no further lubrication for the life of the packings. There is no need to add an inline lubricator under normal operating conditions.

Cleaning the Ram Plate



When done using the tote unloader system for the day, or when cleaning is needed so that a different product can be pumped, perform the following:

1. Raise the ram plate fully.
2. Engage the safety latch. See [Engaging the Safety Latch, page 16](#).
3. On the control panel, make sure the pump is turned off (middle position). If a downstream valve or dispenser is used, verify that it is open and pressure is relieved from the pump.
4. Remove the tote.
5. Remove the seal retainer plate (CC), inflatable seal (1-N), and corner seals (1-P) from the ram plate.
6. Remove the blowoff assembly (BB) and clean with a compatible cleaning fluid.
7. Clean the seals and ram plate with a compatible cleaning fluid.
8. Install the inflatable seal, corner seals, and seal retainer plate on the ram plate.
9. Install the blowoff assembly on the ram plate.

Cleaning the Pump Lower



NOTE: If the installed pumps are double diaphragm, this procedure does not apply. Refer to your pump manual for disassembly and cleaning.

When done using the STU for the day, or when cleaning is needed so that a different product can be pumped, perform the following:

1. Remove the tote. See [Change the Tote, page 29](#).
2. Perform [Pressure Relief Procedure, page 25](#).
3. Lower the ram so that the ram plate is at its lowest point.
4. If desired, flush the pump.
5. Refer to the pump manual for instructions on how to disconnect the air motor from the pump lower.
6. Remove the piping attached to the pump outlet to connection fitting (1-F) for cleaning.
7. Remove the clamp at the large flange connection where the ram plate attaches to the pump lower.
8. Lift the pump, or pump lower out of the ram plate for cleaning.
9. If more than flushing of the pump is necessary, follow the steps in the pump manual for cleaning the pump lower unit.
10. Clean the ram plate. See [Cleaning the Ram Plate, page 31](#).
11. Once all ram plate and pump lower parts have been cleaned, install the seal on the ram plate, pump lowers, and air motors. Attach all air fittings and flange clamps.

Electro-pneumatic Control Panel Display Screens

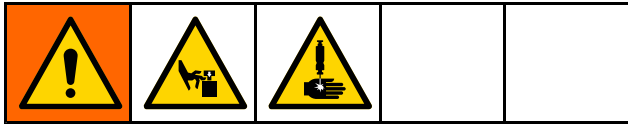

The display screen is a touch screen. The screen can be damaged by pointed or sharp objects. Use only fingertips to make selections on the display.

NOTE: Selection fields and buttons that are grayed-out on the screens are not currently active.

When the system is powered up, the Automatic run screen is displayed. The first time the unloader system is powered up, it will be necessary to perform system setup. See [System Configuration Screen, page 54](#).

On modifiable fields, touching the field will cause either a numeric keypad or alphanumeric keyboard to display. The keyboard or keypad are determined by the type of entry allowed in the selected field.



Numeric keypad

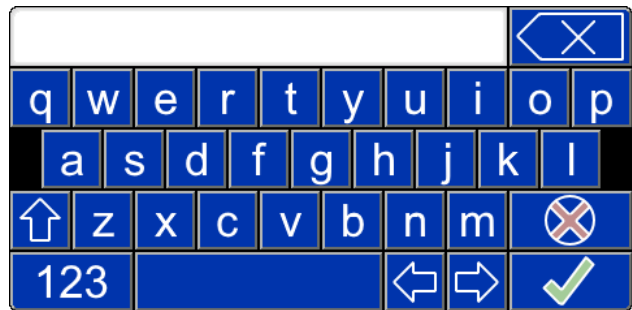

Keyboard alphabet pad

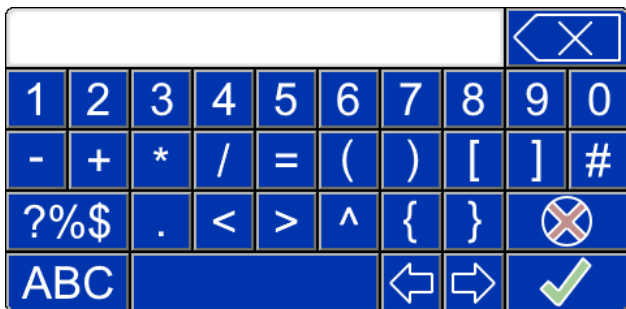



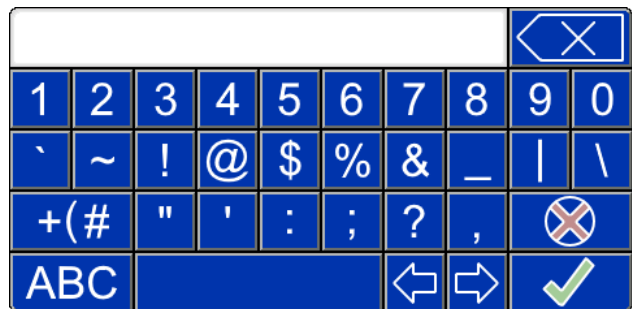

Keyboard numbers and symbols screen 1







Keyboard numbers and symbols screen 2

Specialty key definitions

Key	Description
	Exit Exit the keyboard or keypad. If the entry has not been saved, any displayed entry shown in the top field of the keyboard or keypad is lost.
	Backspace Erase the last character of the displayed entry in the top field of the keyboard or keypad. This key will erase one character each time it is pressed, or multiple if pressed and held.
	Enter When the desired value has been entered in the top field of the keyboard or keypad, press the Enter key to save the value in the selected field on the display screen.
	Shift The shift key is a toggle between upper- and lower-case letters. When pressed, the selected case is used on each key selected until the Shift key is pressed again. Switching screens will reset the shift to lowercase on the new screen.
	Polarity This key toggles the number in the number keypad between positive and negative.

Function Keys

Key	Description
	Run Select the run screens. <ul style="list-style-type: none"> • Automatic • Manual
	Recipes Create or edit recipes. <ul style="list-style-type: none"> • Material Recipes • Container Recipes
	Logs View available logs. <ul style="list-style-type: none"> • Event Log • Job Log
	Settings Configure the STU and connected devices. <ul style="list-style-type: none"> • System Configuration Screen: Edit system configuration • I/O Screen: Edit feedback and I/O settings, view I/O status • Network Screen: Configure settings for network communication • About: Display system and software information

Startup Screen

When the power ON/OFF switch is turned ON, the display shows the startup screen while the system prepares the system for operation.



Automatic Screen

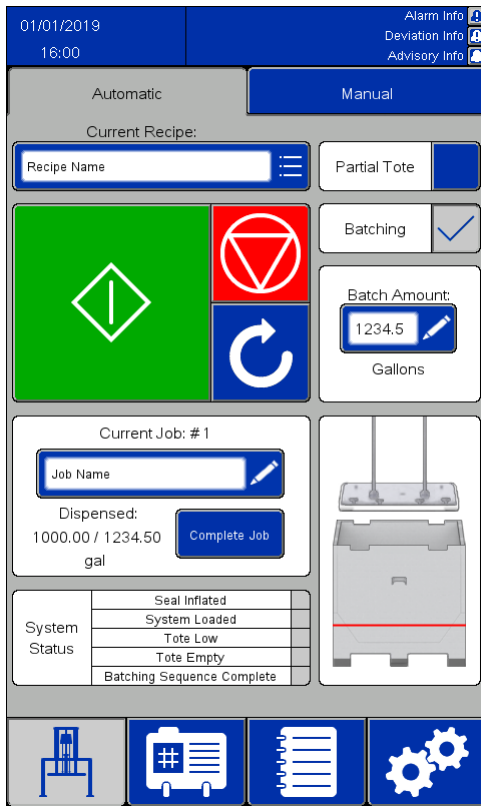

Feedback enabled

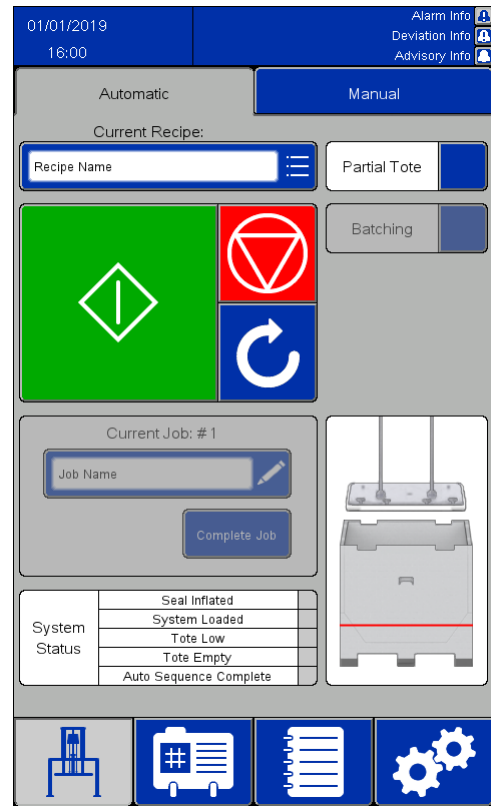





Feedback disabled

NOTES:

- To prime a full tote for automatic operation, press and hold the green start button to advance the ram downwards. Before reaching the top of the tote, the pumps will begin to pump slowly and the ram seal will partially inflate so that an overfilled tote will not spill over. Continue holding the start button until the ram plate is below the top of the tote and the automatic sequence takes over. If the button is released prior to the automatic sequence beginning, will cause ram movement to cease. Press and hold the start button to resume.
- When the partial tote setting is selected, pump operation is delayed until the start button is released and the ram plate is located below the rim of the tote. If the ram plate is not





below the rim of the tote when the start button is released, ram movement ceases.

- If feedback is enabled in system settings:
 - The Current Job field is active. The Current Job box logs how much material has been dispensed since the previous job was completed.
 - The Batching checkbox is active. Selecting the Batching checkbox enables the Batch Amount numeric field and enters the value defined in the selected recipe Default Batch Size field. When the specified amount has been dispensed, the evacuation will cease and await further instruction.
- If Remote Operation is enabled for your STU, see [Remote Operation, page 37](#).

Icon / Field	Description
AUTO SEQUENCE	
Current Recipe	Name of the recipe selected for unloading this tote. Click in this field to display the recipe selection screen.
	Start Begin tote unloading at the current state of the automatic sequence. If the sequence was stopped before completing, the tote unloading resumes at the point where the unloading was stopped.
	Stop Stop tote unloading. If the automatic sequence is not complete, the tote unloading status is retained so that the sequence can be completed if started again.
	Reset Resets the automatic sequence state, deflates the seal, and if "Auto Raise" is selected in the current recipe, will raise the ram.
	Auto Sequence Enabled Flashes in the upper-left corner of the screen next to the date and time once the automatic sequence has been activated. Once the sequence is fully enabled, the icon will also flash over the Start button. NOTE: If the Start button is released too soon during the loading process, then the sequence will stop. The icon will still flash next to the date and time to show that loading started, but did not finish. To continue the automatic sequence, press and hold the Start button until the icon flashes over the Start button.
Partial Tote	Available settings: <input checked="" type="checkbox"/> Partial tote <input type="checkbox"/> Not a partial tote
Batching	If checked, unload the batch size specified in the Batch Amount field. If unchecked, unloading will not automatically stop until the tote has been emptied.
	Ram plate position in the tote. Note: The red line indicates the approximate plate position at which the Tote Low status flag will be set.
STATUS MESSAGES	
Available statuses: <input type="checkbox"/> Condition not met <input checked="" type="checkbox"/> Condition met	
Seal Inflated	The ram plate seal is inflated.
System Loaded	The pump is primed and ready to evacuate the tote. This is based on the pump primed timer.
Tote Low	Ram assembly has reached the Tote Low position.
Tote Empty	Ram assembly has reached the Tote Empty position.

Icon / Field	Description
Auto Sequence Complete	The actions specified by the selected recipe have been completed. When this state is achieved, all other status states are cleared.
Batching Sequence Complete	Displays when Batching has been enabled. When lit, indicates that the dispensed material value specified is achieved.

Remote Operation

				
<p>To avoid injury due to unexpected machine operation initiated by a remote controller, press the Stop button on the screen before servicing the equipment.</p> <p>If the Auto Sequence Enabled icon (⚠️) is flashing, do not service the equipment.</p>				

Use either of the following two system inputs to enable Remote Operation of the pump:

- Discrete input to AUX1 or AUX2. See [Feedback Control Screen, page 56](#).
- Network communication to a remote controller. See [Ethernet/IP, page 60](#).

To load and pump using remote operation:

1. Press the Start button on the screen of your STU to manually begin the automatic or batch sequence. Let the automatic sequence run until the plate is detected inside the container and the pump primes.

NOTE: To ensure that the automatic sequence is fully enabled, check that the

Auto Sequence Enabled icon (⚠️) is flashing in the upper-left corner of the screen *and* flashing over the Start button. If the Auto Sequence Enabled icon is not flashing over the Start button, press and hold the Start button on the screen of your STU until the Start button appears depressed and the Auto Sequence Enabled icon flashes over the Start button.

2. Use the established remote connection to assert the Start/Stop command and control the pump.

NOTE: If the Start/Stop command of the remote connection is asserted, the pumps will run. If the command is not asserted, the pumps will stop until the command is asserted again.



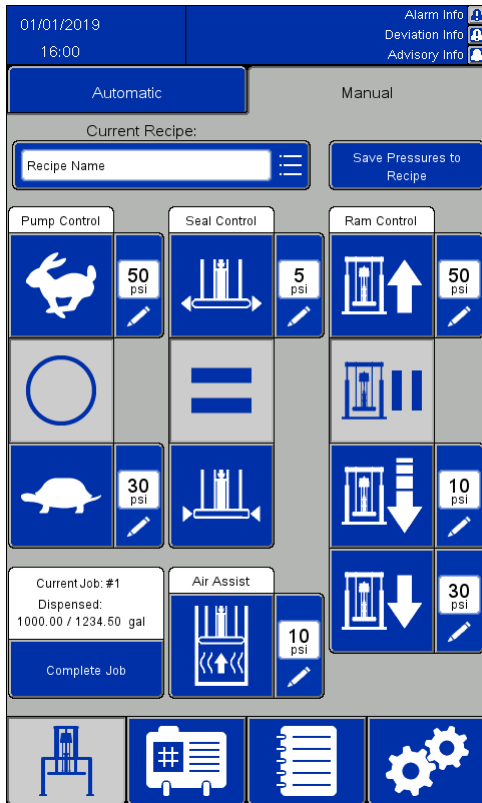

NOTE: The system will halt and the remote connection will not have control if the automatic or batch sequence is stopped by pressing the Stop button or by an alarm occurring. To resume the sequence and re-establish remote connection, press the Start button on the STU screen.











Manual Screen

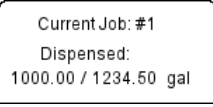

NOTES:

- These buttons are disabled while the automatic sequence is operating.
- Locked recipes disable editing for the pressure boxes on this screen.

Icon/Field	Description
Current Recipe	Name of the recipe selected for unloading this tote. Click in this field to display a recipe selection screen.
	Save Pressures to Recipe Press to save changed pressure settings of the current recipe. If no pressure changes have been made to the current recipe, this icon is not enabled.
	Pressure Settings Numeric displays next to the icons are the pressure settings defined in the current recipe. To change any of these values here will require that the selected recipe is not locked. Changes entered here are not saved to the recipe unless the Save Pressures to Recipe icon is selected prior to exiting this screen. To save changed values will require editing the recipe to reflect the new values.
Pump Control	
	Pump Fast Press to run the pump at a fast speed.
	Pump Off Press to stop the pump.

Icon/Field	Description
	Pump Slow Press to run the pump at a slow speed.
Seal Control	
	Seal Inflate Press to inflate the ram plate seal.
	Stop seal action Stop inflating or deflating the seal. To resume, press the desired seal action button: inflate or deflate.
	Seal Deflate Press to deflate the ram plate seal.
Batch Information	
	Current Job Details of the current batch. This element is only active if feedback has been enabled on the I/O Settings Screen.
	Complete Job Press to mark the current batch as complete. Do not press if the intention is to restart the current batch again.
Air Assist	
	Air Assist Press and hold to blow air between the ram plate and the product to break the adhesion between the two. The ram plate seal should be deflated before performing this operation. NOTE: Air assist will not operate unless Ram Up is also selected.
Ram Control	
	Ram Up Momentarily press to raise the ram assembly. The ram will continue raising until the ram has reached the top of its travel, unless manually stopped by pressing Ram Hold.
	Ram Hold Momentarily press to keep the ram at the current location. NOTE: This is an active hold and the system may momentarily energize Ram Up to keep the platen from drifting. Active hold is enabled for 5 seconds after any Pump, Ram, Seal, or Air Assist command.
	Ram Jog Press and hold to lower the ram assembly. Releasing the button will stop lowering the ram.
	Ram Down Momentarily press to lower the ram to the lowest position. The ram will continue lowering until the ram has reached the bottom of its travel, unless manually stopped by pressing Ram Hold.

Recipe Screens

Recipes define preset settings for unloader operation when unloading defined products. If the STU will be operated manually, it is not necessary to define all recipe settings. However, the current recipe should be unlocked if the ability to adjust the pressures on the manual screen is desired.

Material Recipe screens contain settings based on the material being pumped. A maximum of 100 material recipes can be defined.

Container Recipe screens contain settings based on the design of the container being evacuated. A maximum of 20 container recipes can be defined.







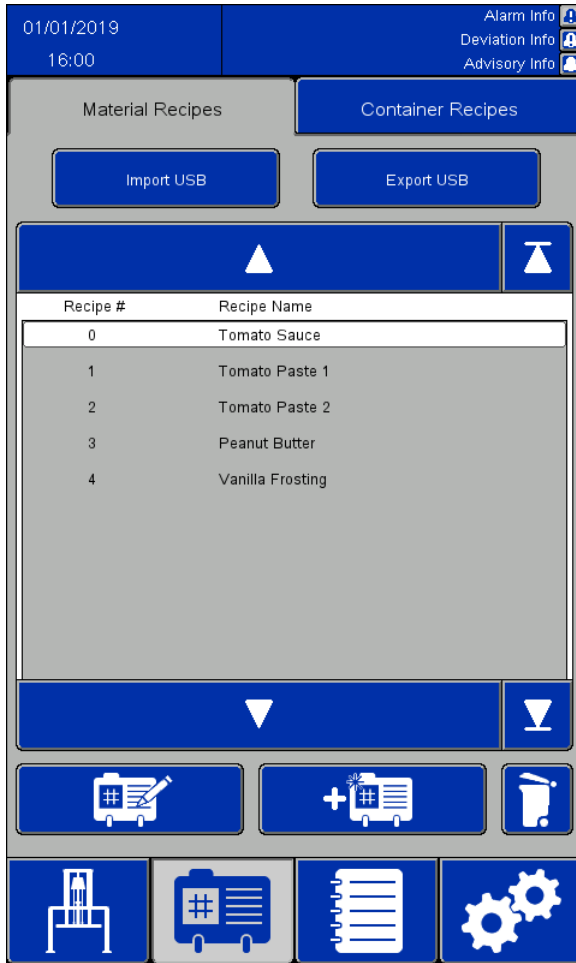

NOTES:

- Recipes may use feedback from external devices to determine when a specific measure of product has been evacuated, so the system settings must be completed before any recipes are defined.
- All material recipes will need to select a container recipe, which defines the design of the tote. Define container recipes prior to defining material recipes.
- The units of measure defined in the system settings are reflected in the recipes. If the units of measure are changed, the values defined in the recipes do not change to match the new unit of measure. Updating the measurement values in the recipes will need to be updated by the user.

Material Recipe Screen



Material Recipes can be exported to a USB device and viewed or edited on a PC, then imported back into the system. See [Import and Export with USB, page 68](#).

Icon/Field	Description
Recipe #	A numeric list of all available recipes. A maximum of 100 (0-99) recipes can be defined.
Recipe Name	User-defined alphanumeric name. The maximum number of characters allowed, including spaces, is 19.
	Move up the recipe list. Momentarily press to move up one recipe. Press and hold to continuously move up the recipe list until releasing the icon or reaching the top of the list.
	Move to the top of the defined recipe list.
	Move down the recipe list. Momentarily press to move down one recipe. Press and hold to continuously move down the recipe list until releasing the icon or reaching the bottom of the list.
	Move to the bottom of the defined recipe list.
	Edit recipe. Move the cursor to the desired recipe and press this icon. The Material Recipe edit screen is displayed.
	Add recipe. Press to define a new recipe. The Material Recipe edit screen is displayed. This will create a recipe with the lowest available recipe number. For example, if recipes 0-20 were defined and Recipe 3 was deleted since, adding a new recipe will result in a new Recipe 3. If 100 recipes have been defined, pressing this icon will select recipe 0 and move to the edit screen.
	Delete selected recipe. Select the desired recipe using the movement arrows and then press this icon to delete the selected recipe. NOTE: Recipe 0 cannot be deleted.
	Import USB Import the Material and Container Recipes from a USB device.
	Export USB Export the Material and Container Recipes to a USB device.



Material Recipe Edit Screen

When creating a new recipe from scratch, default pressure settings are shown. These pressures are good starting points, but most pressure settings will have to be varied to obtain optimal performance for the specific application.

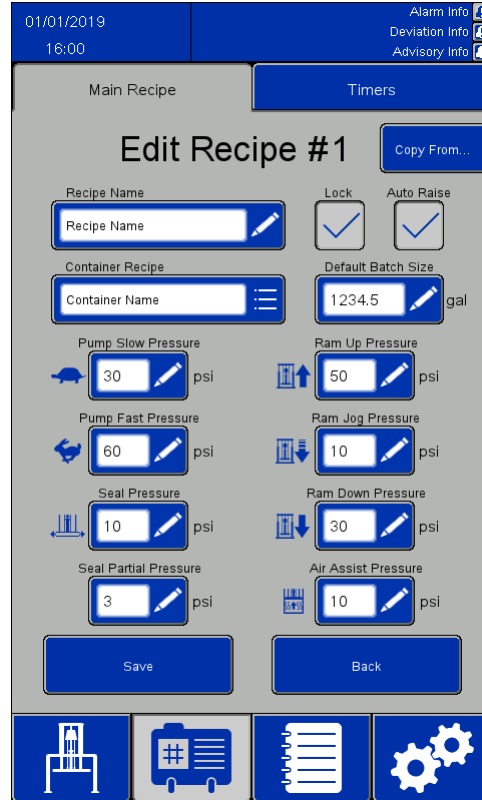
The viscosity of the product being pumped will require a different mix of pressure settings. If differing viscosities of the same product are pumped, a recipe with a defined viscosity can be copied and used as a template to define a new recipe for the additional viscosity. This creates a new recipe without needing to enter all new values. Only the values that must change need to be entered.





Icon/Field	Description
	<p>Copy From... Press to complete the fields of this recipe with the values assigned to another recipe. The copied values will overwrite any defined values in this recipe. After copying, individual fields can be modified to differentiate this recipe from the one copied. NOTE: Copying a locked recipe will also copy the password and save the new recipe as a locked recipe.</p>
Recipe Name	User-defined alphanumeric field, 19 characters maximum.
Lock	<p>When locked, the password defined on the System Settings page must be entered to edit the selected recipe. A locked recipe cannot have pressure settings changed on the Manual screen.</p> <p><input type="checkbox"/> recipe not locked <input checked="" type="checkbox"/> recipe locked</p>
Auto Raise	<p>When checked, an automatic sequence will attempt to lift the ram plate out of the container and raise the ram to the top of its travel. If not checked, the ram plate will remain at the location where it is when an automatic sequence completes. If using batching and the tote is empty before the batch has completed, the ram plate will auto raise so that another tote can be placed and the run button pressed to resume the batch unload.</p> <p><input type="checkbox"/> Auto Raise off <input checked="" type="checkbox"/> Auto Raise on</p>

Icon/Field	Description
Container Recipe	Select from the list of user-defined container recipes.
Default Batch Size	Select a value that is indicative of the normal size of a batch of the product being evacuated. The value can be larger than the contents of the container. In this case, one or more container changes may be required to complete the batch.
Pump Slow Pressure	Select the air pressure to be applied to the pump when running in Pump Slow Speed. Slow Speed runs automatically when loading a new container of material to prime the pump, and at the very end of an empty container.
Pump Fast Pressure	Select the air pressure to be applied to the pump when running in pump fast speed. Fast speed is run to evacuate the bulk of the material from the container.
Air Assist Pressure	Select the air pressure to be applied under the ram plate to aid in unsticking the ram plate from the material or the bottom of an empty tote.
Seal Pressure	Select the air pressure to be applied to the seal while inside the container. Always choose the lowest pressure that achieves the desired result. Too much pressure reduces the life of the seal and creates excessive frictional force opposing movement of the ram. Too little force may cause material to leak past the seal.
Ram Up Pressure	Select the air pressure to lift the ram plate out of the container. Choose the lowest pressure that raises the ram without lifting the container.
Ram Down Pressure	Select the air pressure to push the ram down against the product during evacuation. Always use the lowest pressure that achieves the desired result. Too much down pressure will cause material leakage around the inflatable seal.
Ram Jog Pressure	Select the air pressure to be applied to the ram when jogging downward.
Seal Partial Pressure	Select the air pressure to be applied to the inflatable seal when the ram plate is approaching an overfull container. Choose the lowest pressure that achieves the desired result. Too much Seal Partial Pressure can cause inflatable seal damage during entry into the container, or may even cause the seal to burst.
	Save Save the current values displayed. If this screen is exited without saving, any changes made to the screen are lost.
	Back Return to the recipe list screen. If this screen is exited without saving, any changes made to the screen are lost.

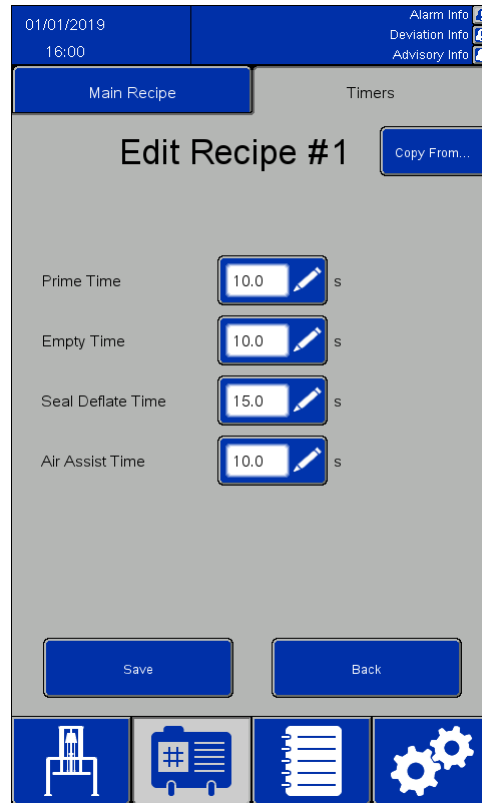
Material Recipe Timers Screen









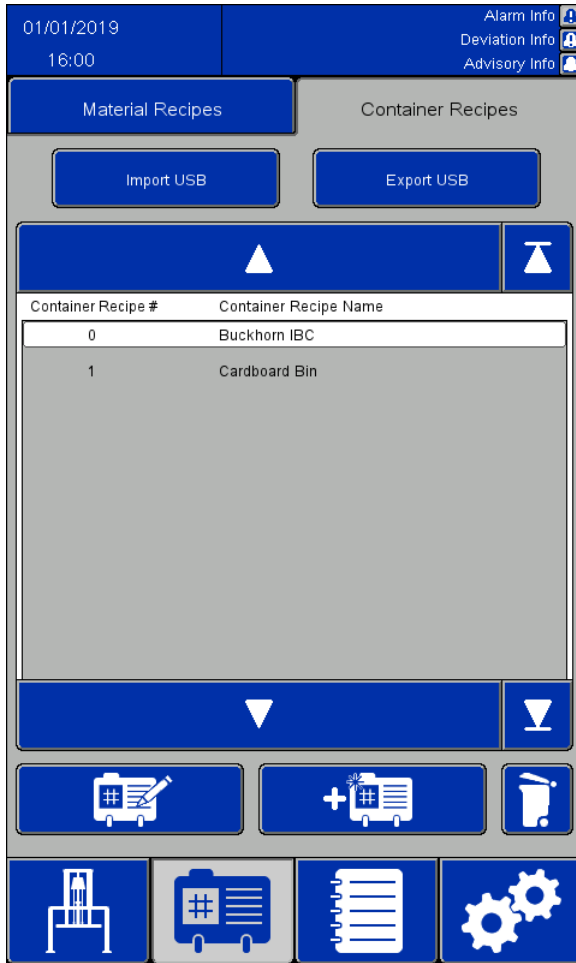

Icon/Field	Description
	<p>Copy From... Press to complete the fields of this recipe with the values assigned to another recipe. The copied values will overwrite any defined values in this recipe. After copying, individual fields can be modified to differentiate this recipe from the one copied. NOTE: Copying a locked recipe will also copy the password and save the new recipe as a locked recipe.</p>
Prime Time	Length of time, in seconds, to attempt to achieve a prime of the pump with the product in the tote. The pump will operate at the slow speed until the amount of time specified by this field has elapsed. The pump will then operate at the fast speed.
Empty Time	When the ram assembly reaches the empty position, the pump will then operate for the amount of time entered in this field. Once this time has elapsed, the pump will stop or raise if Auto Raise is checked.
Seal Deflate Time	Length of time, in seconds, to deflate the ram plate seal.
Air Assist Time	Length of time, in seconds, to apply blowoff air.
	<p>Save Save the current values displayed. If this screen is exited without saving, any changes made to the screen are lost.</p>
	<p>Back Return to the recipe list screen. If this screen is exited without saving, any changes made to the screen are lost.</p>

Container Recipe Screen

Container Recipes can be exported to a USB device and viewed or edited on a PC, then imported back into the system. See [Import and Export with USB, page 68](#).







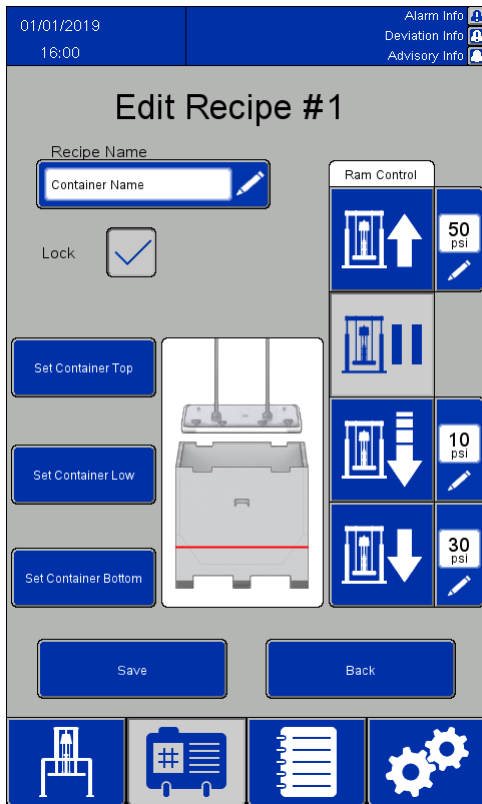

Icon/Field	Description
Recipe #	A numeric list of all available recipes. A maximum of 100 (0-99) recipes can be defined.
Recipe Name	User-defined alphanumeric name. The maximum number of characters allowed, including spaces, is 19.
	Move up the recipe list. Momentarily press to move up one recipe. Press and hold to continuously move up the recipe list until releasing the icon or reaching the top of the list.
	Move to the top of the defined recipe list.
	Move down the recipe list. Momentarily press to move down one recipe. Press and hold to continuously move down the recipe list until releasing the icon or reaching the bottom of the list.
	Move to the bottom of the defined recipe list.
	Edit recipe. Move the cursor to the desired recipe and press this icon. The Container Recipe edit screen is displayed.
	Add recipe. Press to define a new recipe. The Container Recipe edit screen is displayed. This will create a recipe with the lowest available recipe number. For example, if recipes 0-10 were defined and Recipe 3 was deleted since, adding a new recipe will result in a new Recipe 3. If 20 recipes have been defined, pressing this icon will select recipe 0 and move to the edit screen.
	Delete selected recipe. Select the desired recipe using the movement arrows and then press this icon to delete the selected recipe. NOTE: Recipe 0 cannot be deleted.
	Import USB Import the Material and Container Recipes from a USB device.
	Export USB Export the Material and Container Recipes to a USB device.

Container Recipe Edit Screen

An empty tote is required for defining the container recipe.

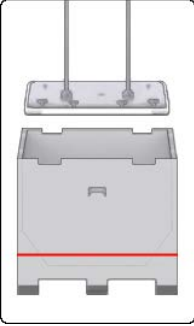

Icon/Field	Description
Recipe Name	User-defined alphanumeric field, 19 characters maximum.
Lock	When locked, the password defined on the System Settings page must be entered to edit the selected recipe. <input type="checkbox"/> recipe not locked <input checked="" type="checkbox"/> recipe locked
	Pressure Settings Numeric displays next to the icons are the pressure settings defined in the current recipe. Changes entered here are not saved to the recipe. A locked recipe will not allow changing these settings.
Ram Control	
	Ram Up Momentarily press to raise the ram assembly. The ram will continue raising until the ram has reached the top of its travel, unless manually stopped.
	Ram Hold Momentarily press to keep the ram at the current location. NOTE: This is an active hold and the system may momentarily energize Ram Up to keep the platen from drifting. Active hold is enabled for 5 seconds after any Pump, Ram, Seal, or Air Assist command.

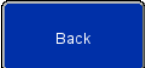
Icon/Field	Description
	<p>Ram Jog Press and hold to lower the ram assembly. Releasing the button will stop lowering the ram.</p>
	<p>Ram Down Momentarily press to lower the ram to the lowest position. The ram will continue lowering until the ram has reached the bottom of its travel, unless manually stopped.</p>
<p>Set Container Top</p>	<p>Position the tote and use the manual controls to lower the ram plate into the tote until the top lip of the ram plate is at the same height as the top lip of the tote. Press the Set Container Top icon to store the position.</p>
<p>Set Container Low</p>	<p>Lower the ram plate into the tote until the ram plate is at the height where the material in the tote is at a low level. Press the Set Container Low icon to store the position. This setting will control when the pumps go from fast pumping to slow pumping to finish evacuating the remaining product from the tote.</p>
<p>Set Container Bottom</p>	<p>Lower the ram plate into the tote until the ram plate is at the bottom of the tote. Press the Set Container Bottom icon to store the position. This setting will instruct the pump to stop pumping, deflate the seal, and raise the ram plate if the auto raise function has been selected.</p>
	<p>This is a visual presentation of the ram plate position settings for this container recipe. It will reflect the positions that have been saved for this recipe. If the value of a setting has not yet been defined, the position of the ram plate, low level, or bottom of tote indications may not be shown in the desired position on the graphic. The red line indicates the location of the current low level position.</p>
	<p>Save Save the current values displayed. If this screen is exited without saving, any changes made to the screen are lost.</p>
	<p>Back Return to the recipe list screen. If this screen is exited without saving, any changes made to the screen are lost.</p>

Event Log

Events are Alarms, Deviations, Advisories, and Records detected by the system. They are logged to assist in troubleshooting the system. Alarms and Deviations will cause the unloader to cease evacuation when they are detected. A user will need to clear the alarm or deviation and restart the unloader.

Event Logs can be exported to a USB device and viewed on a PC. See [Import and Export with USB, page 68](#).

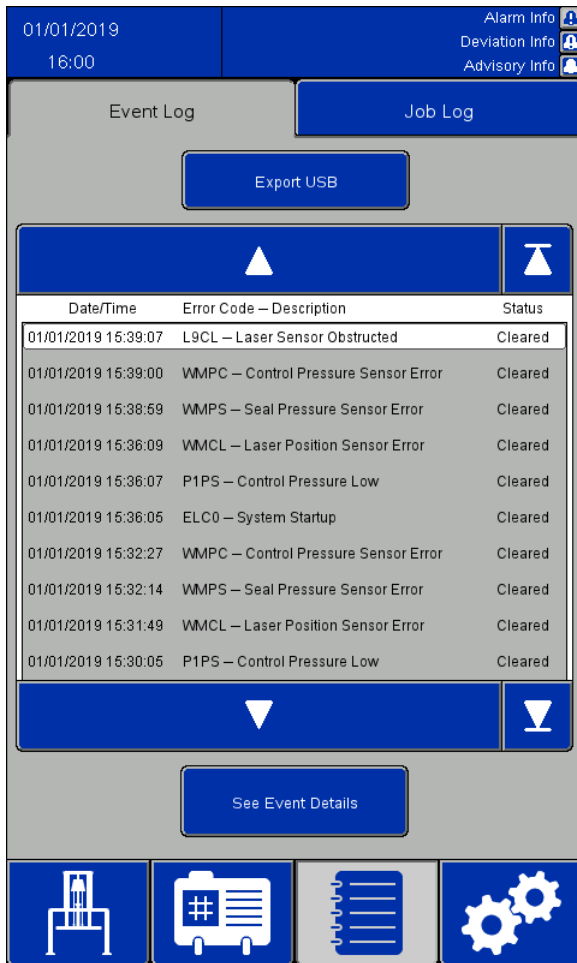

Icon/Field	Description
All Events	Select this field and choose a selection to filter the event list to a single event type.
	Move up the list. Momentarily press to move up one entry. Press and hold to continuously move up the list until releasing the icon or reaching the top of the list.
	Move to the top of the defined list.
	Move down the list. Momentarily press to move down one entry. Press and hold to continuously move down the list until releasing the icon or reaching the top of the list.
	Move to the bottom of the defined list.
	See Event Details Press to see the details for the selected event.
	Export USB Export the Event Log to a USB device.





Alarm Details !

Triggered: 01/01/2019 12:00:00	Acknowledged: 01/01/2019 12:01:00	Cleared: 01/01/2019 12:01:30
--------------------------------------	---	------------------------------------

Error Code: V1CE -- E-stop or I/O Power Error

I/O has lost power. Ensure the Emergency Stop button is not depressed. If problem persists, see the user manual for troubleshooting.

Back

			
<p>ELECTRIC SHOCK HAZARD</p> <p>To reduce the risk of electric shock when accessing the electrical enclosure while power is present:</p> <ul style="list-style-type: none"> All electrical work must be done by a qualified electrician. Wear appropriate personal protective equipment. 			

Event Type	Event Description	Error Code	Cause	Fix
Alarm	Communication bus power error	V1CC	Communication bus has lost power	Restore power to communication bus.
Alarm	Control panel supply pressure low	P1PS	Control supply pressure sensor reads pressure less than the minimum 30 psi required for operation or less than 5 psi below largest pressure required by the current recipe	Increase supply air pressure or reduce pressure required by the current recipe.
Alarm	Control supply pressure sensor error	WMPC	Control supply pressure sensor reports an error	Check control supply pressure sensor and wiring.
Alarm	Emergency stop or I/O power error	V1CE	I/O has lost power	Restore I/O power, reset E-stop button.
Alarm	External interlock #1 open	EBN1	Interlock #1 is enabled and tripped	Close or disable interlock #1.
Alarm	External interlock #2 open	EBN2	Interlock #2 is enabled and tripped	Close or disable interlock #2.
Alarm	Laser position sensor error	WMCL	Laser sensor reports an error	Check laser sensor and wiring.
Alarm	Laser sensor obstructed	L9CL	An obstruction or unintended target of the position sensor has been detected	Ensure the laser has a clear line of sight to the target.
Alarm	Network Communication Error	CCOR	Remote network communication is enabled, but the remote device cannot be found	Verify that the IP addresses of the system and the remote controller are correct. Verify that the system and the remote controller are on the same network. Verify that the remote controller is properly configured as described in Network, page 59 .

Electro-pneumatic Control Panel Display Screens

Event Type	Event Description	Error Code	Cause	Fix
Alarm	Network Initialization Error	CAOR	An error occurred while initializing the system for network communication	Restart the system. Contact Graco Support if the problem persists.
Alarm	Network Interlock Open	EBOR	The network interlock is tripped	Ensure proper output from the remote controller or disable the remote connection.
Alarm	Pump supply pressure low	P1PP	Pump supply pressure sensor reads pressure more than 5 psi below the pressure being driven	Increase supply air pressure or reduce pressure required by the current recipe.
Alarm	Pump supply pressure sensor error	WMPP	Pump supply pressure sensor reports an error	Check pump supply pressure sensor and wiring.
Alarm	Ram movement timeout	EU1R	Upward ram movement has not reached the minimum height when the ram movement timeout completes	Check ram for obstructions to movement, manually raise ram.
Alarm	Seal inflation timeout	EU1S	Seal has not inflated to within 1.0 psi of the value being driven when the seal inflation timeout completes	Check seal and air lines.
Alarm	Seal not deflated	P71S	Seal pressure sensor does not read the seal is depressurized after seal deflation timeout completes	Check seal, manually deflate seal, adjust Seal Deflate Time in recipe.
Alarm	Seal pressure sensor error	WMPS	Seal pressure sensor reports an error	Check seal pressure sensor and wiring.
Alarm	Software Error	WX00	Unexpected state detected in the software	Acknowledge the alarm. If the alarm is triggered regularly, contact Graco.
Alarm	X20AO2622 analog output module error	WMCA	X20AO2622 module reports an error	Check X20AO2622 module and wiring. Verify that the modules are installed in the proper locations*.
Alarm	X20BC1083 bus coupler module error	WMCB	X20BC1083 module reports an error	Check X20BC1083 module and wiring. Verify that the modules are installed in the proper locations*.
Alarm	X20CM8281 mixed module error	WMCC	X20CM8281 module reports an error	Check X20CM8281 module and wiring. Verify that the modules are installed in the proper locations*.
Alarm	X20DO8322 digital output module error	WMCD	X20DO8322 module reports an error	Check X20DO8322 module and wiring. Verify that the modules are installed in the proper locations*.
Alarm	X20DS438A IO-LINK module error	WMCS	X20DS438A module reports an error	Check X20DS438A module and wiring. Verify that the modules are installed in the proper locations*.
Alarm	X20PS9400 power supply module error	WMCP	X20PS9400 module reports an error	Check X20PS9400 module and wiring. Verify that the modules are installed in the proper locations*.
Deviation	File not found	WSU0	The file targeted by a USB Import could not be found.	Verify the file name is correct (has not been changed from the name given during a USB export) and that it is located within a directory named "STU-[serial number]".

Electro-pneumatic Control Panel Display Screens

Event Type	Event Description	Error Code	Cause	Fix
Deviation	Position sensor dirty	L2CL	Position sensor reflectivity value is low.	Ensure the laser sensor and target are clear of debris.
Deviation	USB data format error	WSU2	The data in the file targeted by a USB import contains incorrectly formatted data.	Verify data is formatted correctly. No commas or new lines should be inserted while modifying a file for importing into the system.
Deviation	USB file header error	WSU1	The information in the header of the file targeted by a USB import contains an incorrect or incorrectly formatted Software Part Number or Software Version.	Verify Software Part Number and Software Version and correct and formatted correctly in the file header.
Deviation	USB not connected	CCU0	A USB device is not connected to the system.	Verify the USB device is compatible with the system, formatted properly, and inserted fully into one of the USB ports on the back of the screen unit. A USB device can take up to 10 seconds to be recognized by the system once inserted.
Deviation	USB operation failed	WXU0	A USB import or export command was not able to be completed: an unspecified error occurred during the operation.	check that the USB device is fully inserted into the USB ports on the back of the screen unit. If importing, check formatting of data in files and remove any unnecessary files from the directory.
Advisory	USB Export Successful	EQUE	USB Export operation completed successfully.	N/A
Advisory	USB Import Successful	EQUI	USB Import operation completed successfully.	N/A
Record	System Depressurization	P010	A depressurization sequence was completed.	N/A
Record	System Startup	ELCO	The system started up and the boot sequence completed.	N/A
Record	System Time Changed	ECT0	The system time was changed by more than one minute.	N/A

* Modules must be installed in the following order, from left to right:

- X20BC1083
- X20PS9400
- X20CM8281
- X20DS438A
- X20AO2622
- X20DO8322

Job Log

The Job Log screen displays a historical log of jobs completed by the system. Pressing the Job Complete button on the Automatic or Manual run screens will automatically snapshot recipe settings and information about the dispensed material, assign a Job Number, and log it here. A Job Name of up to 39 characters can be assigned to a job on the Automatic run screen to differentiate it from other job logs easily. The Job Name must be entered before pressing the Job Complete button.

Job Logs can be exported to a USB device and viewed on a PC. See [Import and Export with USB, page 68](#).

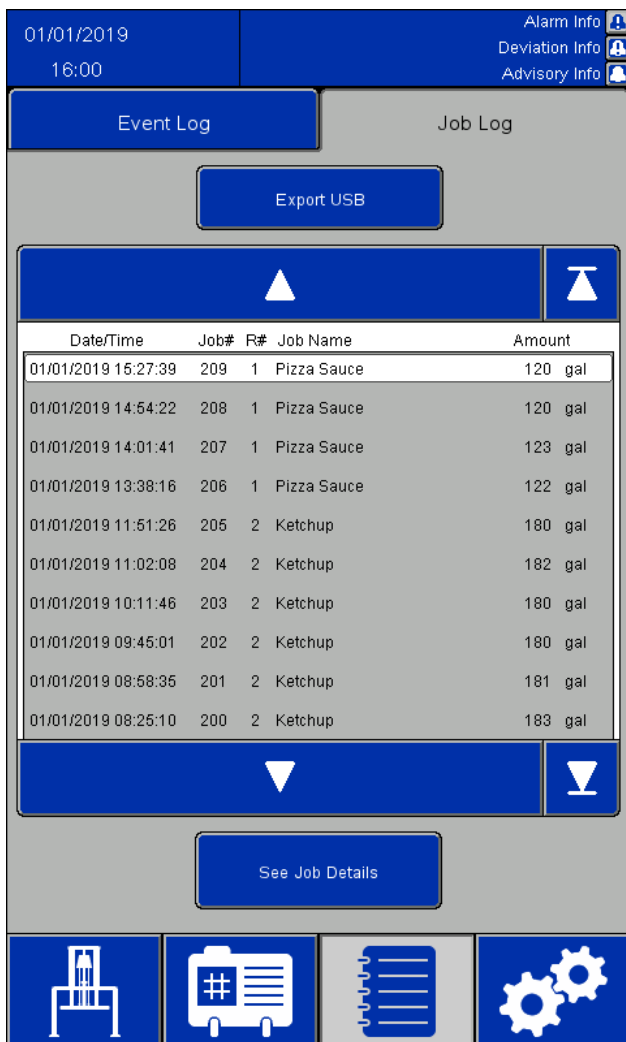

Icon/Field	Description
	Move up the list. Momentarily press to move up one entry. Press and hold to continuously move up the list until releasing the icon or reaching the top of the list.
	Move to the top of the defined list.
	Move down the list. Momentarily press to move down one entry. Press and hold to continuously move down the list until releasing the icon or reaching the bottom of the list.
	Move to the bottom of the defined list.
	See Job Details Press to see the details for the selected job.
	Export USB Press to export the Job Log to a USB device.

The screenshot shows a 'Job Details' screen with a blue header and a grey body. The header contains the title 'Job Details' and a menu icon. The body contains a list of job parameters and a 'Back' button at the bottom.

Job #:	1
Job Name:	Job Name
Amount Dispensed:	25.0 gal
Target Amount:	25.0 gal
Recipe #:	0
Recipe Name:	Recipe Name
Time Started:	10/24/2019 10:33:58
Time Completed:	10/24/2019 10:34:06
Pump Pressure:	50.0 psi
Ram Down Pressure:	30.0 psi
Seal Pressure:	5.0 psi
Multiple Containers:	FALSE
Recipe Changed:	FALSE
Error Occurred:	FALSE

Back

A Job Log contains the following information:



- Job Number
- Job Name
- Amount Dispensed
- Target Amount for batching
- Recipe Number used for the job
- Name of recipe used for the job
- The time the job was started
- The time the job completed
- Pump pressure of the recipe
- Ram Down pressure of the recipe
- Seal pressure of the recipe
- A "Multiple Containers" indicator that is TRUE if a sequence empties the first container it was evacuating from. Otherwise it is FALSE.
- A "Recipe Changed" indicator that is TRUE if the active material recipe is changed, if the recipe pressures are changed on the Manual run screen, or if any values for the active recipe are edited on the Material Recipe Edit screen and saved. Otherwise it is FALSE.
- An "Error Occurred" indicator that is TRUE if an alarm or deviation occurs while the job is active. Otherwise it is FALSE.

System Configuration Screen

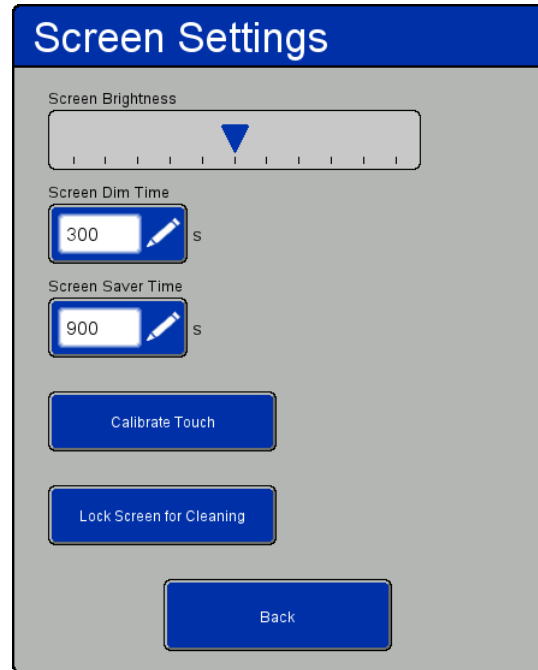
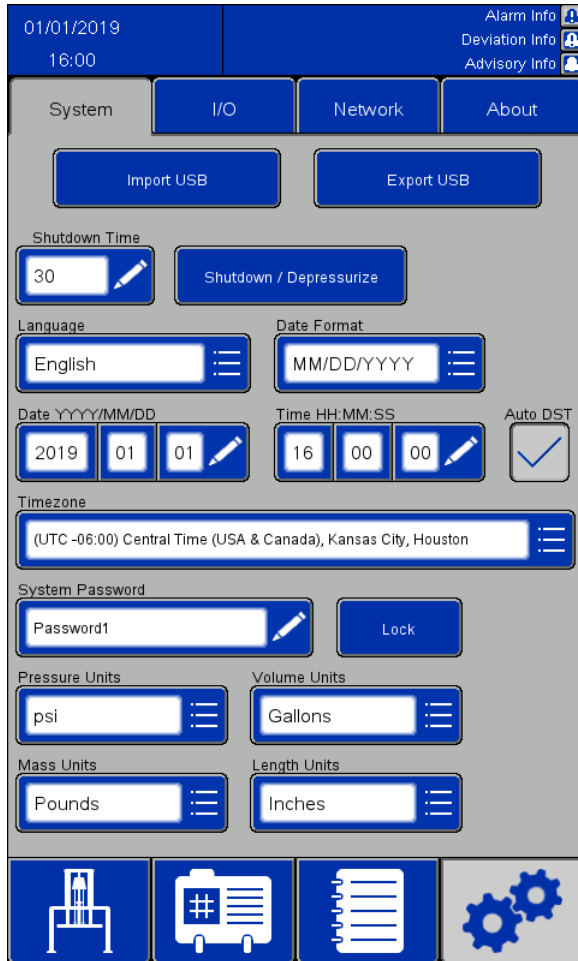

The system configuration screen defines the STU parameters. The system settings can be exported to a USB device and viewed or edited on a PC, then imported back into the system. See [Import and Export with USB](#), page 68.

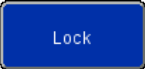

Icon/Field	Description
	Import USB Import the system settings from a USB device.
	Export USB Export the system settings to a USB device.
	Shutdown/Depressurize Press to vent pressure from the system. If the ram is raised and not locked or held in place, it will move down as venting occurs. When done, an acknowledge message appears and requires user response.

Icon/Field	Description
	<p>Shutdown Time Shutdown Time, in seconds. Enter the amount of time to allow for system depressurization. If the system has not been depressurized by the time the specified time has elapsed, an alarm will be generated.</p>
	<p>Screen Settings Press to show the screen settings window. Use the window to set the screen brightness, dim time, screen saver time, touch calibration, and briefly block touches to clean the touch screen.</p>
<p>Language</p>	<p>Select the desired language.</p>
<p>Date Format</p>	<p>Select the desired date format.</p>
<p>Date</p>	<p>Enter the current date.</p>
<p>Time</p>	<p>Enter the current time.</p>
<p>Auto DST</p>	<p>Check to enable automatic time adjustments for daylight savings time.</p>
<p>Timezone</p>	<p>Select the desired timezone. The system time will need to be set after switching timezones.</p>
<p>Password</p>	<p>Enter the desired password to be used to access the control box display screens. Verify the accuracy of the entry prior to selecting the keyboard return key. NOTE: This field is case-sensitive.</p>
	<p>Lock If a password has been set, press the Lock button to immediately lock all settings from being edited. Enter the password to unlock the settings. The system will automatically lock after two minutes if a password is set and the user leaves the settings menu without pressing Lock.</p>
<p>Pressure Units</p>	<p>Select between PSI, MPa, or bar.</p>
<p>Mass Units</p>	<p>Select between pounds and kilograms.</p>
<p>Volume Units</p>	<p>Select between gallons, cubic feet, liters, or cubic meters.</p>
<p>Length Units</p>	<p>Select between inches and centimeters.</p>

Feedback Control Screen

			
<p>To reduce the risk of injury due to electric shock, remove power to the control panel before entering the control panel to make connections for measurement devices.</p>			

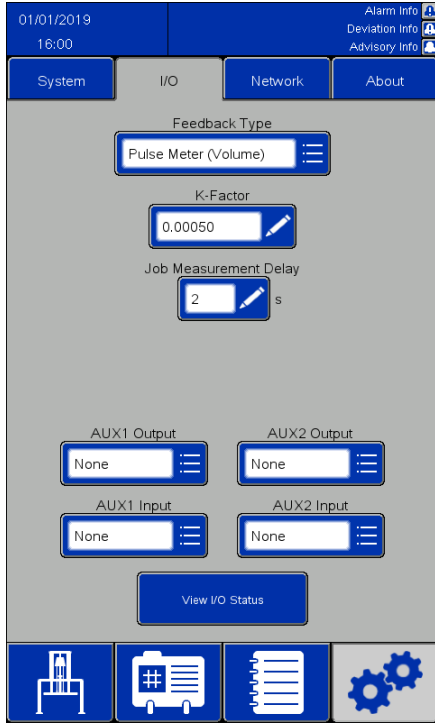

Selecting scale feedback

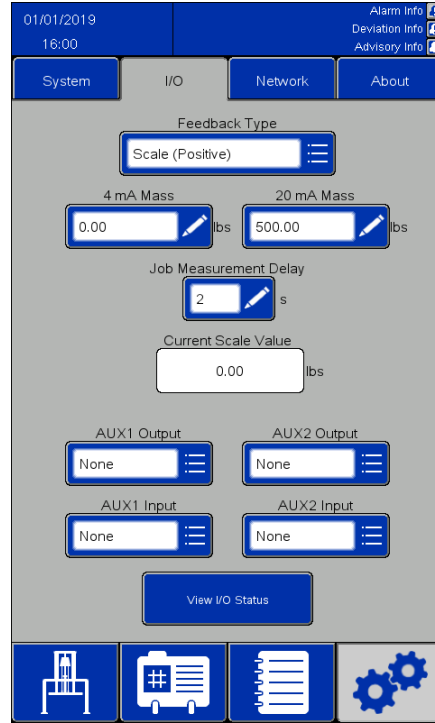

Selecting pulse feedback

Icon/Field	Description
Feedback Type	<p>Select feedback type:</p> <ul style="list-style-type: none"> • None: No feedback enabled. • Pulse Meter (Volume): A pulse meter measuring volume dispensed must be connected to CM8281-12 (20 kHz max) to use this feedback type. • Pulse Meter (Mass): A pulse meter measuring mass dispensed must be connected to CM8281-12 (20 kHz max) to use this feedback type. • Scale (Positive): A scale measuring weight is connected; weight is increasing as material is dispensed. • Scale (Negative): A scale measuring weight is connected; weight is decreasing as material is dispensed. This input is used if the STU system is mounted on a scale.
K-Factor*	This field appears if a pulse meter type input is selected. Set the unit value a single pulse represents.
20 mA Mass**	This field appears if a scale type input is selected. Set the weight associated with the 20 mA signal input in this field.

Icon/Field	Description
4 mA Mass**	This field appears if a scale type input is selected. Set the weight associated with the 4 mA signal input in this field.
Aux 1 Input	CM8281-11 Input Voltage Asserted: >16 VDC. Not Asserted: <5 VDC Select input type: <ul style="list-style-type: none"> • None: Not monitored. • Start/Stop: See Remote Operation, page 37. • Ready Interlock: The system will Alarm if Not Asserted. • Job Complete: The system will complete and log a job if Asserted, provided there has been some amount of material dispensed.
Aux 2 Input	CM8281-21 Input Voltage Asserted: >16 VDC. Not Asserted: <5 VDC Select input type: <ul style="list-style-type: none"> • None: Not monitored. • Start/Stop: See Remote Operation, page 37. • Ready Interlock: The system will Alarm if Not Asserted. • Job Complete: The system will complete and log a job if Asserted, provided there has been some amount of material dispensed.
Aux1 Output	CM8281-13 Output Voltage Asserted: 24 VDC. Not Asserted: 0 VDC Select output type: <ul style="list-style-type: none"> • None: Not monitored. • System OK: Asserted while no Alarms are active. • Pump Run: Asserted while the pumps are running. • Sequence Complete: Asserted after an Automatic or Batching sequence has completed. • Container Low: Asserted when the system is below the “Container Low” point during operation. • Container Empty: Asserted when the system has emptied the container during operation.
Aux2 Output	CM8281-23 Output Voltage Asserted: 24 VDC. Not Asserted: 0 VDC Select output type: <ul style="list-style-type: none"> • None: Not monitored. • System OK: Asserted while no Alarms are active. • Pump Run: Asserted while the pumps are running • Sequence Complete: Asserted after an Automatic or Batching sequence has completed. • Container Low: Asserted when the system is below the “Container Low” point during operation. • Container Empty: Asserted when the system has emptied the container during operation.
Job Measurement Delay	Delay after a batch is completed, during which the amount pumped is still recorded. Default is 2 seconds, but may be set up to 5 seconds.
Current Scale Value	Displays the current read value from the scale.

* See [Setting K-Factor, page 58](#) for more information.

** See [Setting Scale Feedback, page 58](#) for more information.

Setting K-Factor

In order for a batching cycle to accurately measure product, the K-Factor must be appropriately set and the system outlet fluid lines fully loaded.

A calibration routine can be run to validate/adjust the K-Factor setting.

1. Complete the current Job to reset the batch amount.
2. Dispense desired test amount of material.
3. Validate the actual amount of material dispensed (volume or mass).
4. Calculate and enter the new K-Factor:

$$\{\text{New K-Factor}\} = \{\text{Old K-Factor}\} \times \frac{\{\text{actual dispensed amount}\}}{\{\text{job dispensed amount}\}}$$

NOTE: If using “Pulse Meter (Mass)” and the product density changes, the K-Factor value must be re-calibrated. Otherwise, the batch may not be accurate.

Setting Scale Feedback

In order for a batching cycle to accurately measure product, the 4 mA Mass and 20 mA



Mass settings for the Scale (Positive) or Scale (Negative) must be set appropriately.

- 4 mA Mass: Set this value to the actual weight of the product setting on the scale (including the container) when the output of the scale is 4 mA.
- 20 mA Mass: Set this value to the actual weight of the product setting on the scale (including the container) when the output of the scale is 20 mA.

Although the unloader system only uses differences in weights during batching, it is important to use the same container when setting 4 mA Mass and 20 mA Mass values. After the values are set, the actual weight of the container is not important.

NOTE: If product density changes, the 4 mA Mass and 20 mA Mass values must be re-set. Otherwise the batch may not be accurate.

Network

				
<p>To reduce the risk of injury due to electric shock, remove power to the control panel before entering the control panel to make connections for measurement devices.</p>				

Use the Network page to configure the STU for network communication.

Currently, the system is only configured to communicate through Ethernet/IP (EIP) protocol to a remote programmable logic controller (PLC). Contact Graco Customer Support for information regarding network communication protocols.

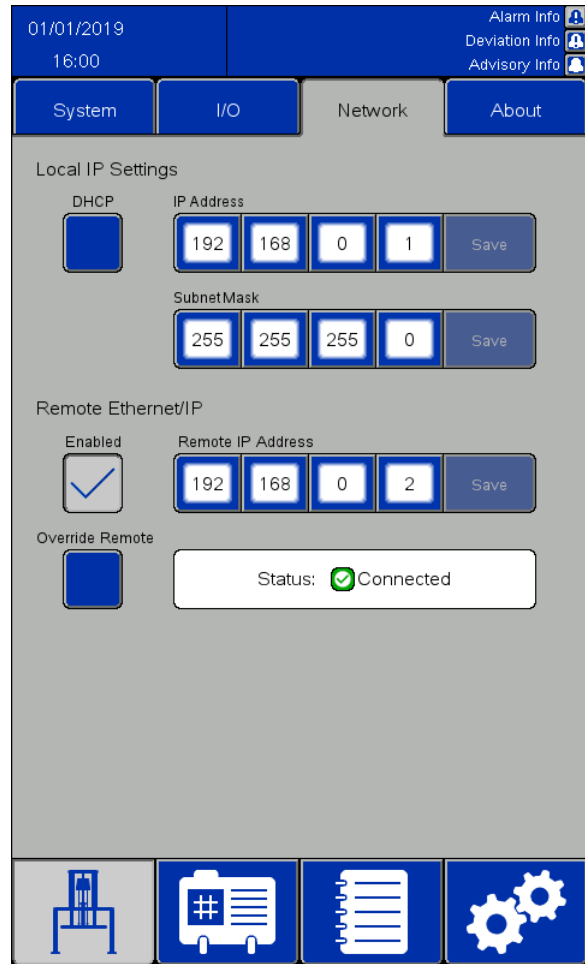

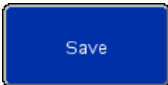
Icon/Field	Description
DHCP	Check to enable Dynamic Host Configuration Protocol for the network connection.
IP Address	The current IP Address of the system is displayed here. If DHCP is disabled, these fields become editable to enter a static IP address.
Subnet Mask	The current Subnet Mask utilized by the system is displayed here. If DHCP is disabled, these fields become editable to enter a Subnet Mask.
Enable Ethernet/IP	Check to enable EIP network communication.
Remote IP Address	Enter the IP Address of the remote PLC for the system to talk to.
	Save The Save button will be active if the IP Address, Subnet Mask, or the Remote IP Address have been edited. Press the Save button to save the edited value before leaving the Network screen. Changes may be lost if the Save button is not pressed. If network communication is enabled, restart the system to resume network communication after saving a value in the Network settings.
Override Remote	Check to stop reading values driven by the remote PLC into the system. If a sequence is running, select the Override Remote box to stop the sequence and put the system in standby.
Ethernet/IP Status	Shows if the active communication is connected or disconnected from the remote PLC.

Ethernet/IP

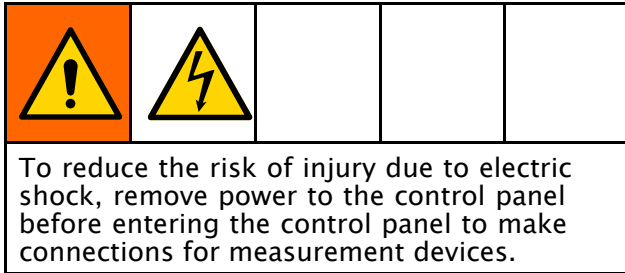

A network cable is required to use Ethernet/IP communication with a remote Allen-Bradley PLC. Insert the network cable into the IF2 port on the back side of the screen unit.

NOTE: The minimum Requested Packet Interval (RPI) for this interface is 20 milliseconds.

NOTE: The Ethernet/IP interface uses implicit messaging. One variable bank is for inputs, and one variable bank is for outputs.

Connect a Remote PLC

Contact Graco Customer Support to obtain a configuration file with the .L5K file extension needed for this procedure. Then, follow this procedure to configure the remote PLC to communicate with the control panel.

NOTE: These instructions are for configuring an Allen-Bradley PLC using the Studio 5000 software.

1. Import the .L5K file into Studio 5000 to create a new Studio 5000 project.

NOTE: Contact Graco Customer Support to obtain a configuration file with the .L5K file extension.
2. Export the following settings from the project:
 - a. The controller tags
 - b. The "CopyEthIP" program (located under Tasks)
 - c. The "AssembInType" and "AssembOutType" data types (located under User-Defined Data Types)
3. Open the run-time project, where the settings from Step 2 will be imported.

4. In the run-time Studio 5000 project, create the Ethernet/IP communication module.
 - a. Under Ethernet, select ETHERNET-MODULE to create a new generic Ethernet module.
 - b. Configure the module exactly as the ETHERNET-MODULE is configured in the project with the imported .L5K file, except for the IP Address. Enter the IP Address assigned to the STU system.
 - c. After creating the module, set the RPI to a minimum of 20 milliseconds in the Connection Properties.
5. Right-click on User-Defined Data Types and import the "AssembInType" and "AssembOutType" data types.
6. Import the controller tags: Select *Tools > Import > Tags and Logic Comments*.

This will create EthIP_In and EthIP_Out data types in the controller tags with all variables named in the Variable Interface List.
7. Right-click on the Main Task and import the CopyEthIP program. Once the CopyEthIP program is done importing, the configuration for the Ethernet/IP communication with the Allen-Bradley PLC will be complete. Modify the program as needed within bounds of the protocol.
8. For remote communication, configure the IP Address, Subnet Mask, and the Remote IP Address on the Network page of the STU. See [Network, page 59](#).
9. Enable the Ethernet/IP communication on the STU system.

NOTE: Restart the STU to initiate communication between the PLC and the STU.

Variable Interface List

Allen-Bradley PLC variables are prepended with the following naming structures:

Input: BR2AB_
Output: AB2BR_

NOTE: All output variables correspond to a variable on the input interface. The output variables are sent back from the STU so that the remote PLC can verify that the sent value was seen by the STU system.

NOTE: The STU must be told which variables to read from the Allen-Bradley PLC. Set the AB2BR_networkOverwriteBitfield variable appropriately to control the STU system remotely.

Outputs from the Allen-Bradley Controller			
Variable Name	Data Type	Possible Values	Notes
AB2BR_evnt_acknowledge	BOOL	TRUE, FALSE	Sensitive to rising edge. Acknowledges the active alarm in the STU system.
AB2BR_networkInterlock	BOOL	TRUE, FALSE	System will not operate if remote connection is active and AB2BR_networkInterlock is FALSE
AB2BR_pumpStartStop	BOOL	TRUE (Evacuate), FALSE (Stop evacuation)	See Remote Operation, page 37 .
AB2BR_jobComplete	BOOL	TRUE, FALSE	Sensitive to rising edge. Completes the current job and logs it to the STU system.
AB2BR_rec_loadRecipe	BOOL	TRUE, FALSE	Sensitive to rising edge. To load a different recipe, ensure the other recipe exists in the system, set AB2BR_rec_recipeNumber, and set the AB2BR_rec_loadRecipe variable to TRUE.
AB2BR_rec_recipeNumber	SINT	SINT	Corresponds to bit 0 in the AB2BR_networkOverwriteBitfield variable.
AB2BR_rec_autoRaise	BOOL	TRUE, FALSE	Corresponds to bit 1 in the AB2BR_networkOverwriteBitfield variable.
AB2BR_rec_pumpSlowPressure_psi	REAL	REAL	Corresponds to bit 2 in the AB2BR_networkOverwriteBitfield variable. Units in psi.
AB2BR_rec_pumpFastPressure_psi	REAL	REAL	Corresponds to bit 3 in the AB2BR_networkOverwriteBitfield variable. Units in psi.
AB2BR_rec_ramUpPressure_psi	REAL	REAL	Corresponds to bit 4 in the AB2BR_networkOverwriteBitfield variable. Units in psi.
AB2BR_rec_ramDownPressure_psi	REAL	REAL	Corresponds to bit 5 in the AB2BR_networkOverwriteBitfield variable. Units in psi.
AB2BR_rec_ramJogPressure_psi	REAL	REAL	Corresponds to bit 6 in the AB2BR_networkOverwriteBitfield variable. Units in psi.
AB2BR_rec_sealFullPressure_psi	REAL	REAL	Corresponds to bit 7 in the AB2BR_networkOverwriteBitfield variable. Units in psi.
AB2BR_rec_sealPartPressure_psi	REAL	REAL	Corresponds to bit 8 in the AB2BR_networkOverwriteBitfield variable. Units in psi.

Outputs from the Allen-Bradley Controller			
Variable Name	Data Type	Possible Values	Notes
AB2BR_rec_airAssistPressure_psi	REAL	REAL	Corresponds to bit 9 in the AB2BR_networkOverwriteBitfield variable. Units in psi.
AB2BR_rec_primeTime_s	INT	INT	Corresponds to bit 10 in the AB2BR_networkOverwriteBitfield variable. Units in seconds.
AB2BR_rec_emptyTime_s	INT	INT	Corresponds to bit 11 in the AB2BR_networkOverwriteBitfield variable. Units in seconds.
AB2BR_rec_sealDeflateTime_s	INT	INT	Corresponds to bit 12 in the AB2BR_networkOverwriteBitfield variable. Units in seconds.
AB2BR_rec_airAssistTime_s	INT	INT	Corresponds to bit 13 in the AB2BR_networkOverwriteBitfield variable. Units in seconds.
AB2BR_rec_batchAmount-Mass_lbs	REAL	REAL	Corresponds to bit 14 in the AB2BR_networkOverwriteBitfield variable. If batching is enabled, the evacuation will halt when the amount of material pumped matches this value. Units in pounds.
AB2BR_rec_batchAmountVolume_gal	REAL	REAL	Corresponds to bit 15 in the AB2BR_networkOverwriteBitfield variable. If batching is enabled, the evacuation will halt when the amount of material pumped matches this value. Units in gallons.
AB2BR_batchEnabled	BOOL	TRUE, FALSE	Corresponds to bit 16 in the AB2BR_networkOverwriteBitfield variable. This switches between an "Auto" sequence and a "Batch" sequence.
AB2BR_networkOverwriteBitfield	DINT	Bitfield	This variable is used as a bitfield, where every denoted output variable has a corresponding bit. If the remote PLC intends the STU to read the value in from the Ethernet/IP network interface and make it active in the system, the corresponding bit for that variable must be set to TRUE in this bitfield. When a bit is set to TRUE, any value changes from the STU's touchscreen (including loading a new recipe) will be overwritten by the network value, unless "Override Remote" is checked on the STU Network screen. When a bit is FALSE, the STU system ignores the network value.

Inputs to the Allen-Bradley Controller			
Variable Name	Data Type	Possible Values	Notes
BR2AB_systemState	DINT	0 (Sys Busy), 1 (Standby), 2 (Manual Run), 3 (Auto Run)	N/A
BR2AB_containerLow	BOOL	TRUE, FALSE	N/A
BR2AB_containerEmpty	BOOL	TRUE, FALSE	N/A
BR2AB_sealInflated	BOOL	TRUE, FALSE	N/A
BR2AB_systemLoaded	BOOL	TRUE, FALSE	N/A
BR2AB_batchSequenceComplete	BOOL	TRUE, FALSE	This will only be set if batch target has been achieved. If the batching sequence ends by emptying the container, the "BR2AB_autoSequenceComplete" variable will be set instead.
BR2AB_autoSequenceComplete	BOOL	TRUE, FALSE	This will be set when an Auto sequence completes, or a Batch sequence empties a container before reaching the target batch amount.
BR2AB_currentJobNumber	DINT	DINT	N/A
BR2AB_ramPosition_in	REAL	REAL	Identifies the distance from the laser position sensor to the top beam or plate of the system. Units are inches.
BR2AB_jobAmountMass_lbs	REAL	REAL	Amount of material pumped in the current job if a "Mass" type feedback is selected in system settings. Otherwise, this variable has a value of -1. Units in pounds.
BR2AB_jobAmountVolume_gal	REAL	REAL	Amount of material pumped in the current job if a "Volume" type feedback is selected in system settings. Otherwise, this variable has a value of -1. Units in gallons.
BR2AB_scaleReading_lbs	REAL	REAL	Identifies the current value of a scale if a scale is connected and configured in the system. Units in pounds.
BR2AB_evnt_eventTimestamp	DINT	DINT	Timestamp in Unix time.
BR2AB_evnt_eventGroup	SINT	0 (Alarm), 1 (Deviation), 2 (Advisory)	Has a value of 255 if no events need acknowledgment. See Event Table.
BR2AB_evnt_eventIndex	SINT	SINT	Has a value of 255 if no events need acknowledgment. See Event Table.
BR2AB_evnt_acknowledge	BOOL	TRUE, FALSE	N/A
BR2AB_networkInterlock	BOOL	TRUE, FALSE	N/A

Inputs to the Allen-Bradley Controller			
Variable Name	Data Type	Possible Values	Notes
BR2AB_pumpStartStop	BOOL	TRUE (Evacuate), FALSE (Stop evacuation)	N/A
BR2AB_jobComplete	BOOL	TRUE, FALSE	N/A
BR2AB_rec_loadRecipe	BOOL	TRUE, FALSE	N/A
BR2AB_rec_recipeNumber	SINT	SINT	N/A
BR2AB_rec_autoRaise	BOOL	TRUE, FALSE	N/A
BR2AB_rec_pumpSlowPressure_psi	REAL	REAL	Units in psi.
BR2AB_rec_pumpFastPressure_psi	REAL	REAL	Units in psi.
BR2AB_rec_ramUpPressure_psi	REAL	REAL	Units in psi.
BR2AB_rec_ramDownPressure_psi	REAL	REAL	Units in psi.
BR2AB_rec_ramJogPressure_psi	REAL	REAL	Units in psi.
BR2AB_rec_sealFullPressure_psi	REAL	REAL	Units in psi.
BR2AB_rec_sealPartPressure_psi	REAL	REAL	Units in psi.
BR2AB_rec_airAssistPressure_psi	REAL	REAL	Units in psi.
BR2AB_rec_primeTime_s	INT	INT	Units in seconds.
BR2AB_rec_emptyTime_s	INT	INT	Units in seconds.
BR2AB_rec_sealDeflateTime_s	INT	INT	Units in seconds.
BR2AB_rec_airAssistTime_s	INT	INT	Units in seconds.
BR2AB_rec_batchAmount-Mass_lbs	REAL	REAL	If batching is enabled, the evacuation will halt when the amount of material pumped matches this value. This has a value of -1 unless a "Mass" type feedback is selected in system settings. Units in pounds.
BR2AB_rec_batchAmountVolume_gal	REAL	REAL	If batching is enabled, the evacuation will halt when the amount of material pumped matches this value. This has a value of -1 unless a "Volume" type feedback is selected in system settings. Units in gallons.
BR2AB_batchEnabled	BOOL	TRUE, FALSE	N/A
BR2AB_networkOverwriteBit-field	DINT	Bitfield	N/A

STU Event Table

See [Event Log, page 48](#) for detailed event descriptions.

NOTE: The Event Identification Numbers in the following table consist of values from BR2AB_evnt_eventGroup and BR2AB_evnt_eventIndex (see [Variable Interface List, page 60](#)). The Event Identification Numbers are listed in the order of BR2AB_evnt_eventGroup, BR2AB_evnt_eventIndex.

Event Identification Number	Event
0,0	Software Error
0,1	E-stop or I/O Power Error
0,2	Comm. Bus Power Error
0,3	X20AO2622 Module Error
0,4	X20BC1083 Module Error
0,5	X20CM8281 Module Error
0,6	X20DO8322 Module Error
0,7	X20PS9400 Module Error
0,8	X20DS438A Module Error
0,9	Laser Position Sensor Error
0,10	Seal Pressure Sensor Error
0,11	Control Pressure Sensor Error

Event Identification Number	Event
0,12	Pump Pressure Sensor Error
0,13	Control Pressure Low
0,14	Pump Pressure Low
0,15	Interlock #1 Open
0,16	Interlock #2 Open
0,17	Seal Not Deflated
0,18	Ram Movement Timeout
0,19	Seal Inflation Timeout
0,20	Laser Sensor Obstructed
0,21	Network Communication Error
0,22	Network Interlock Open
1,0	Position Sensor Dirty
1,1	File Not Found
1,2	USB File Header Error
1,3	USB Data Format Error
1,4	USB Not Connected
1,5	USB Operation Failed
2,0	USB Import Successful
2,1	USB Export Successful

About

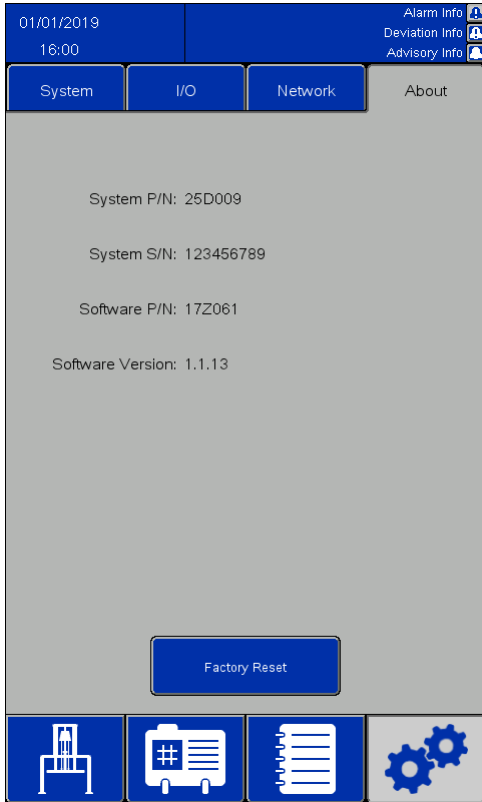

The About screen displays the STU software information.



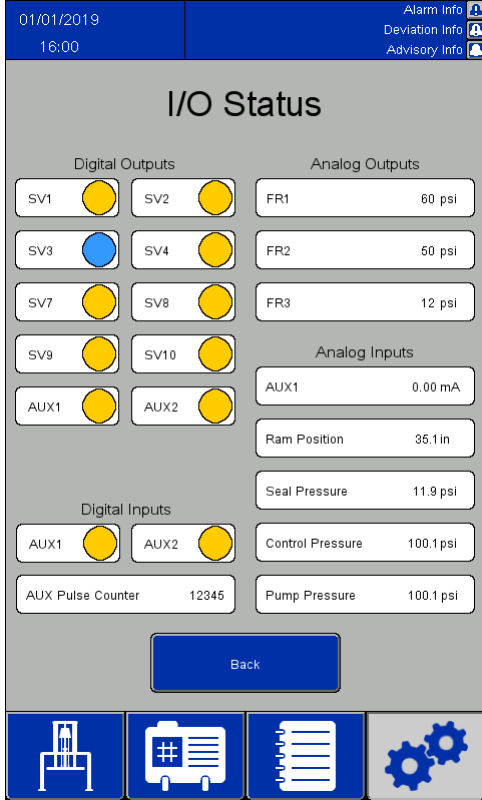

Icon/Field	Description
	<p>Factory Reset Removes all user-defined data. This includes locked recipes and passwords, system configuration data, pressure settings, etc.</p>

I/O Status Screen



Icon / Field	Active Conditions
Digital Outputs	
Available settings:	
	(blue) Asserted
	(yellow) Not Asserted
SV1	Pump fast
SV2	Pump slow, pump fast
SV3	Ram up
SV4	Ram jog, ram down
SV7	Seal inflate
SV8	Air assist
SV9	Ram check
SV10	Seal deflate
Aux 1	Auxiliary 1 output
Aux 2	Auxiliary 2 output
Digital Inputs	
Aux 1	Auxiliary 1 input
Aux 2	Auxiliary 2 input
AUX Pulse Counter	Total flow meter pulse count
Analog Outputs	
FR1	Pump pressure
FR2	Ram pressure
FR3	Seal pressure
Analog Inputs	
Aux 1 analog input	Current 4–20 mA scale reading
Ram Position	Current ram position reading
Seal Pressure	Current seal pressure reading
Control Air Pressure	Current control air pressure reading
Pump Air Pressure	Current pump air pressure reading
	Back Return to previous screen

Import and Export with USB

				
To reduce the risk of injury due to electric shock, remove power to the control panel before entering the control panel to access the USB port.				

Material and Container Recipes, Event Logs, Job Logs, and System Settings can be exported to a USB device from their respective screens when the USB device is inserted into one of the two ports on the back side of the screen unit. The exported files are a .csv file type with a UTF-8 encoding.

The Material Recipes file, Container Recipes file, and the System Settings file may be edited in a program on a computer and imported back into the system once the USB device is inserted back into the back side of the screen unit. When editing files for import, use a program that supports saving the file in a UTF-8 encoding, such as Notepad. Microsoft Excel is not recommended.

If importing a file from a previous version of software than the version located on the About screen, follow these steps to avoid data loss:

1. Make a backup of the desired file on a PC.
2. Insert the USB device into the screen unit and export the desired file to obtain the up-to-date formatting of the file. **NOTE:** This will overwrite any existing file with the same name.
3. On a PC, copy the desired data from the backup file into the file created by the export. Do not copy any header information. Ensure formatting is correct: no extra commas, the correct number of lines, and each line of data has a new line at the end of it (including the last line of the file).
4. Save the file, ensuring UTF-8 encoding. Then import it to the system.

Settings Parameters

When modifying some elements for import, the Settings file requires use of numerical values to represent desired values. The allowable values for all fields are detailed in the following table:

Parameter Name	Value	Value Meaning
Language	0	English
	1	French
	2	Spanish
	3	German
	4	Dutch
Timezone	5	(UTC -12:00) International date line (west)
	10	(UTC -11:00) Midway Islands, Samoa
	15	(UTC -10:00) Hawaii
	20	(UTC -09:00) Alaska
	25	(UTC -08:00) Pacific Time (USA & Canada), San Francisco, Vancouver
	30	(UTC -07:00) Arizona
	35	(UTC -07:00) Mountain Time (USA & Canada), Denver, Salt Lake City
	40	(UTC -07:00) Chihuahua, Mazatlan
	45	(UTC -06:00) Guadalajara, Mexico City, Monterrey
	50	(UTC -06:00) Central Time (USA & Canada), Kansas City, Houston
	55	(UTC -06:00) Saskatchewan

Parameter Name	Value	Value Meaning
Timezone	60	(UTC -05:00) Bogotá, Lima, Quito
	65	(UTC -05:00) New York, Miami, Atlanta, Detroit, Toronto
	70	(UTC -05:00) Cuba
	75	(UTC -05:00) Indiana (east)
	80	(UTC -04:00) Caracas, La Paz
	85	(UTC -04:00) Santiago
	90	(UTC -04:00) Atlantic Time (Canada)
	95	(UTC -03:30) Newfoundland
	100	(UTC -03:00) Greenland
	105	(UTC -03:00) Brazil
	110	(UTC -03:00) Buenos Aires, Georgetown
	115	(UTC -02:00) Mid Atlantic
	120	(UTC -01:00) Azores
	125	(UTC -01:00) Cape Verde
	130	(UTC) Dublin, Edinburgh, Lisbon, London
	135	(UTC) Casablanca, Monrovia
140	(UTC +01:00) Amsterdam, Berlin, Bern, Rome, Stockholm, Vienna	
145	(UTC +01:00) Belgrade, Bratislava, Budapest, Ljubljana, Prague	

Parameter Name	Value	Value Meaning
Timezone	150	(UTC +01:00) Brussels, Copenhagen, Madrid, Paris
	155	(UTC +01:00) West Central Africa
	160	(UTC +01:00) Sarajevo, Skopje, Warsaw, Zagreb
	165	(UTC +02:00) Athens, Beirut, Istanbul, Minsk
	167	(UTC +02:00) Kaliningrad
	170	(UTC +02:00) Bucharest
	175	(UTC +02:00) Helsinki, Kiev, Riga, Sofia, Tallinn, Vilnius
	180	(UTC +02:00) Cairo
	185	(UTC +02:00) Harare, Pretoria
	190	(UTC +02:00) Jerusalem
	195	(UTC +03:00) Nairobi
	200	(UTC +03:00) Baghdad
	205	(UTC +03:00) Kuwait, Riyadh
	210	(UTC +03:00) Moscow, St. Petersburg, Volgograd
	215	(UTC +03:30) Tehran
	220	(UTC +04:00) Abu Dhabi, Muscat
	225	(UTC +04:00) Samara
	230	(UTC +04:00) Baku, Tbilisi, Yerevan
	235	(UTC +04:30) Kabul
	240	(UTC +05:00) Yekaterinburg
245	(UTC +05:00) Islamabad, Karachi, Tashkent	

Parameter Name	Value	Value Meaning
Timezone	250	(UTC +05:30) Chennai, Calcutta, Bombay, New Delhi
	255	(UTC +05:45) Kathmandu
	260	(UTC +06:00) Almaty
	265	(UTC +06:00) Novosibirsk
	270	(UTC +06:00) Astana, Dhaka
	275	(UTC +06:00) Sri Jayawardenpura Kotte
	280	(UTC +06:30) Rangoon
	285	(UTC +07:00) Bangkok, Hanoi, Jakarta
	290	(UTC +07:00) Krasnoyarsk
	295	(UTC +08:00) Peking, Chongqing, Hong Kong, Urumqi
	300	(UTC +08:00) Irkutsk, Ulan Bator
	305	(UTC +08:00) Perth
	310	(UTC +08:00) Kuala Lumpur, Singapore
	315	(UTC +08:00) Taipei
	320	(UTC +09:00) Osaka, Sapporo, Tokyo
	325	(UTC +09:00) Seoul
	330	(UTC +09:00) Yakutsk
	335	(UTC +09:30) Adelaide; Darwin
340	(UTC +10:00) Vladivostok	
345	(UTC +10:00) Brisbane	

Parameter Name	Value	Value Meaning
Timezone	350	(UTC +10:00) Canberra, Melbourne, Sydney
	355	(UTC +10:00) Guam, Port Moresby
	360	(UTC +10:00) Hobart
	365	(UTC +11:00) Magadan, Solomon Is., New Caledonia
	367	(UTC +11:00) Srednekolymsk
	370	(UTC +12:00) Auckland, Wellington
	375	(UTC +12:00) Fiji, Kamchatka, Marshall Is.
	380	(UTC +13:00) Nuku'alofa
	Auto DST	0
1		Enabled
Date Format	0	MM/DD/YYYY
	1	DD/MM/YYYY
	2	YYYY/MM/DD
System Password	Any alpha-numeric, up to 19 characters	N/A
Shutdown Time	Enter desired time (in seconds)	N/A
Job Measurement Delay	Enter desired time (in seconds)	N/A
Pressure Units	0	psi
	1	Megapascals
	2	Bar
Length Units	0	Inches
	1	Centimeters

Parameter Name	Value	Value Meaning
Volume Units	0	Gallons
	1	Cubic Feet
	2	Liters
	3	Cubic Meters
Mass Units	0	Pounds
	1	Kilograms
Feedback Type	0	None
	1	Pulse Meter (Volume)
	2	Pulse Meter (Mass)
	3	Scale (Positive)
	4	Scale (Negative)
K-Factor	Enter desired pulses per unit	N/A
4 mA Mass	Enter desired mass at 4 mA	N/A
20 mA Mass	Enter desired mass at 20 mA	N/A

Parameter Name	Value	Value Meaning
AUX1/2 Input	0	None
	1	Pump Start/Stop
	2	Interlock
	3	Job Complete
AUX1/2 Output	0	None
	1	System OK
	2	Pump is Running
	3	Sequence Complete
	4	Container Low
IP Type	0	DHCP Disabled (Static IP)
	1	DHCP Enabled
IP Address	Enter desired IP address	N/A
Subnet Mask	Enter desired subnet mask	N/A

Dimensions

Wash Bin

Sample Configuration Number STU.A01BAB2AA0C21

Sanitary Tote Unloader	Frame	Pu-mp	Plate	Seal Type	Seal Material	Con-trol	Accessories	Wash Bin	Certifica-tion
STU	A	01	B	A	B	2	AA	1	C21

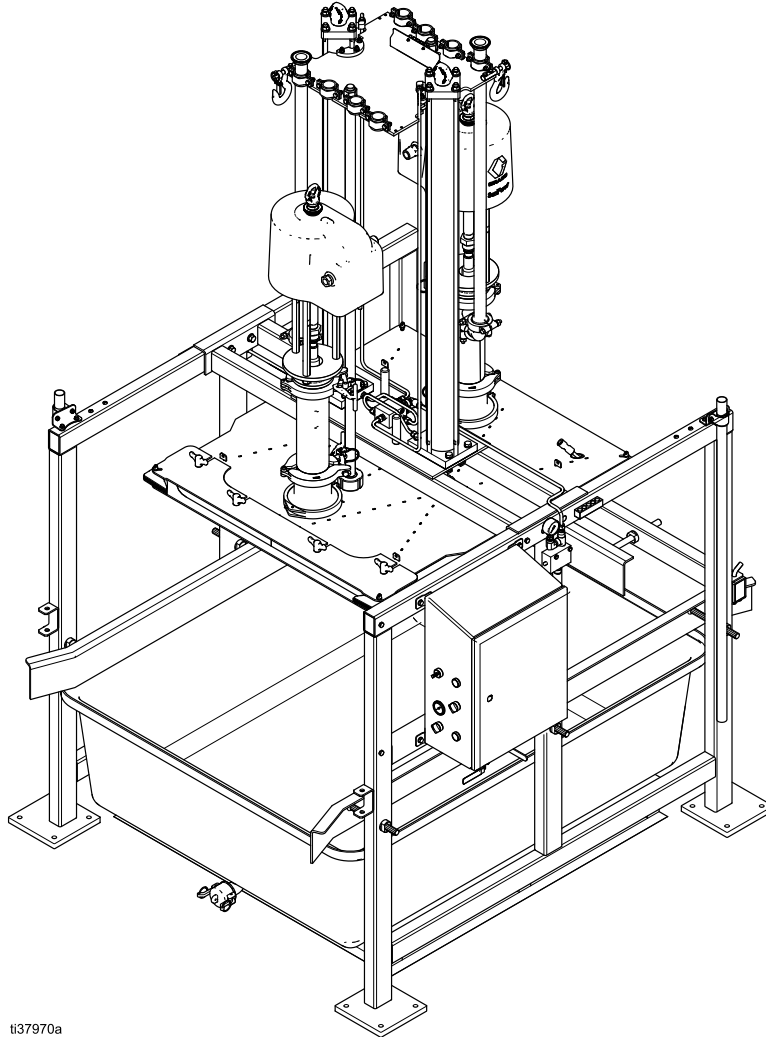

ti37970a

Wash Bin Config Code	Part	Title	Description	Refer to manual:
0	---	---	---	---
1	25N650	Wash Bin	Polypropylene wash bin mounted on an aluminum pallet. Uses a 2.125 outside-diameter polypropylene cam-and-groove fitting for drainage (included).	---

STU Dimensions

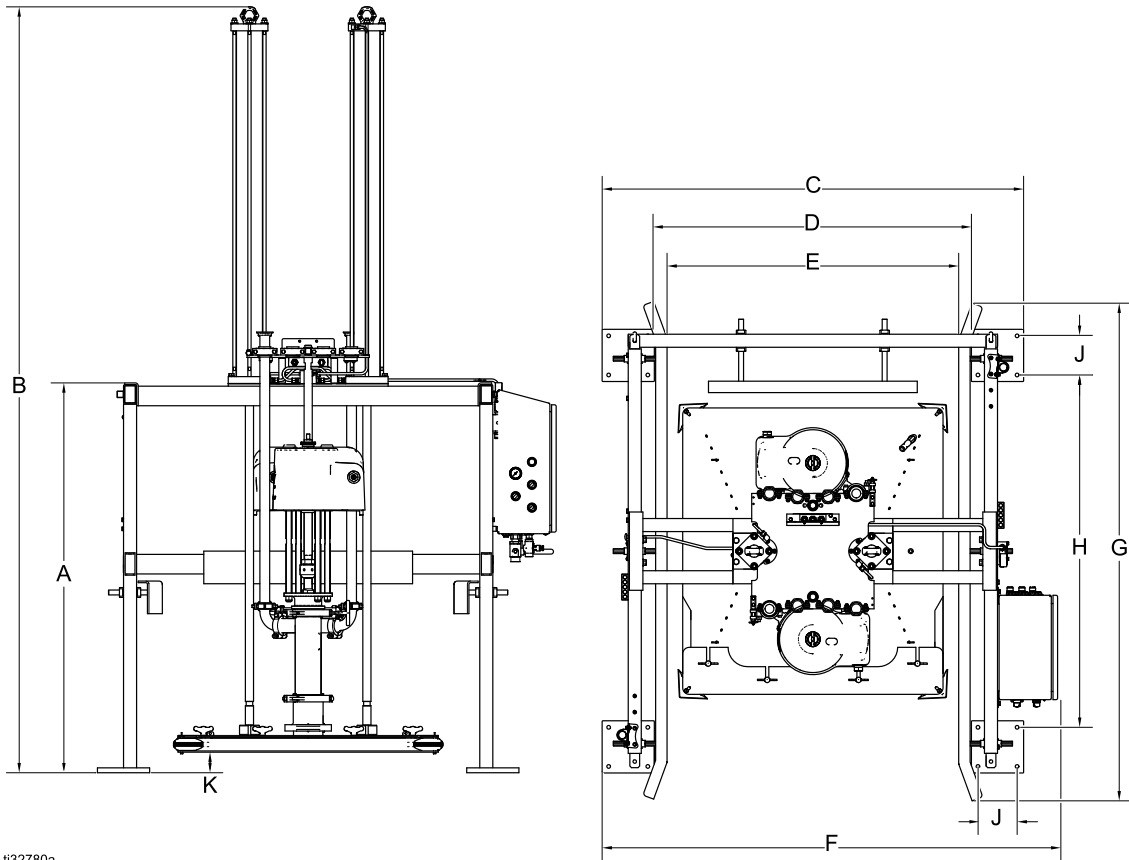

ti32780a

A in. (cm)	B in. (cm)	C in. (cm)	D in. (cm)	E in. (cm)	F in. (cm)	G in. (cm)	H in. (cm)	J in. (cm)	K in. (cm)	
									Lowest Position	Highest Position
59.5 (151)	117.3 (298)	64.6 (164)	48.6 (123)	49 max. (124.5)	70 (178)	76.5 (194)	54 (137)	6 (15.2)	3.2 (8.1)	50.8 (129)

Schematic (pneumatic control)

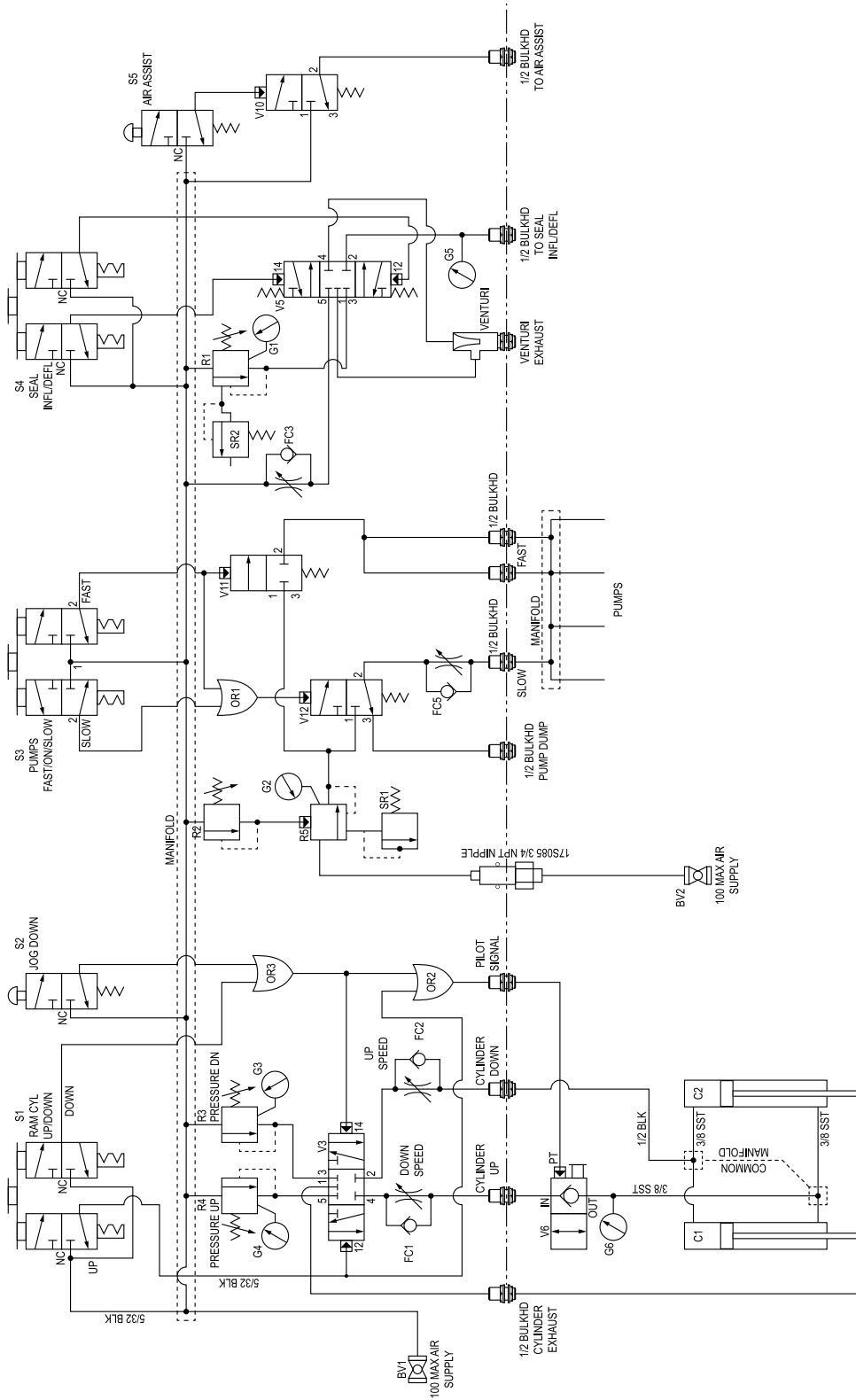

Schematic (electo-pneumatic control)

* Maximum 15 A branch circuit protection and disconnect switch shall be provided by the installer.

wire. All field wiring terminals are a class 1 control circuit.

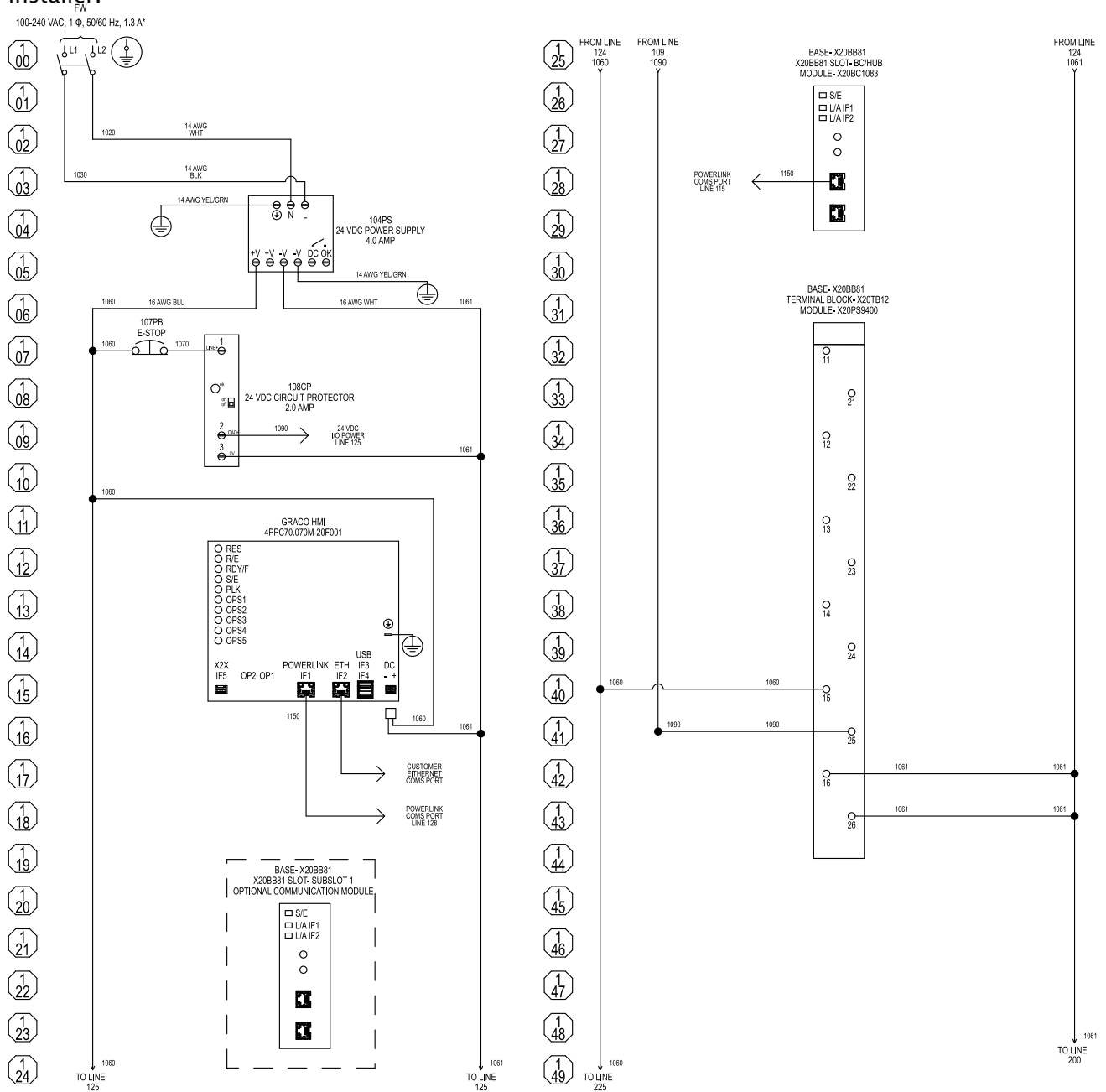

All connections marked as FW are field wired connections. Except for the equipment grounding conductor connection, all field wiring connections are to be made with 24-14 AWG (0.20-2.0 mm²) stranded copper wire. The equipment grounding conductor must be a minimum of 14 AWG (2.0 mm²) stranded copper

Schematic (electo-pneumatic control)

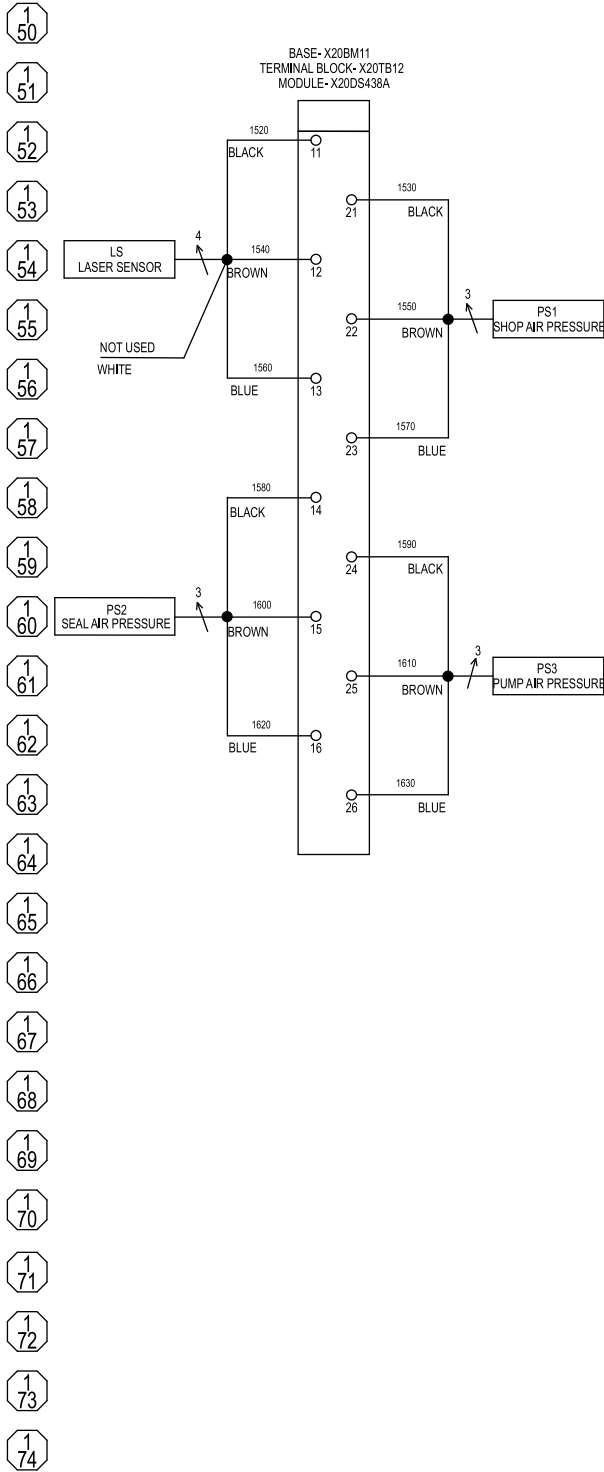

Schematic (electo-pneumatic control)

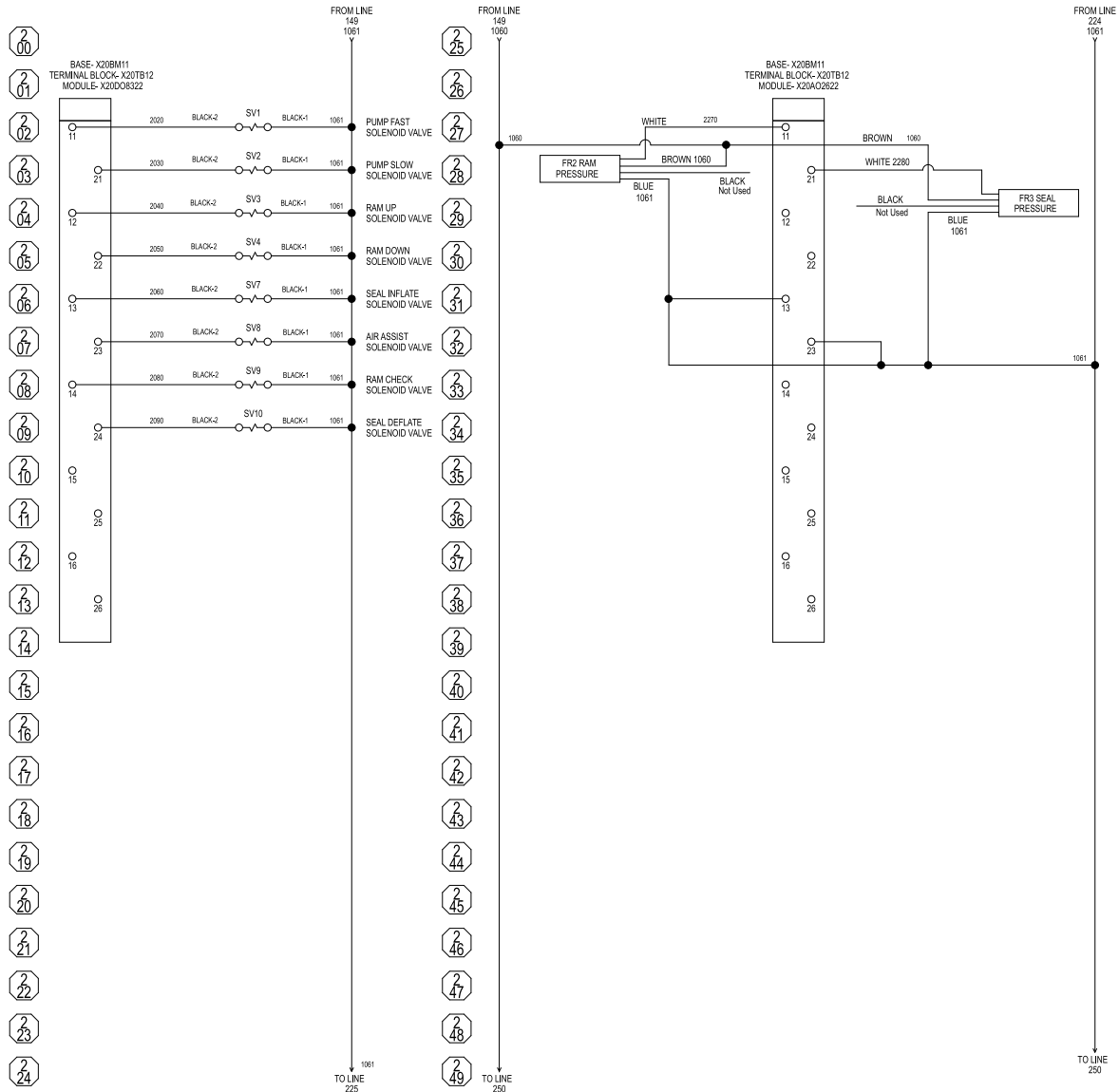

Schematic (electo-pneumatic control)

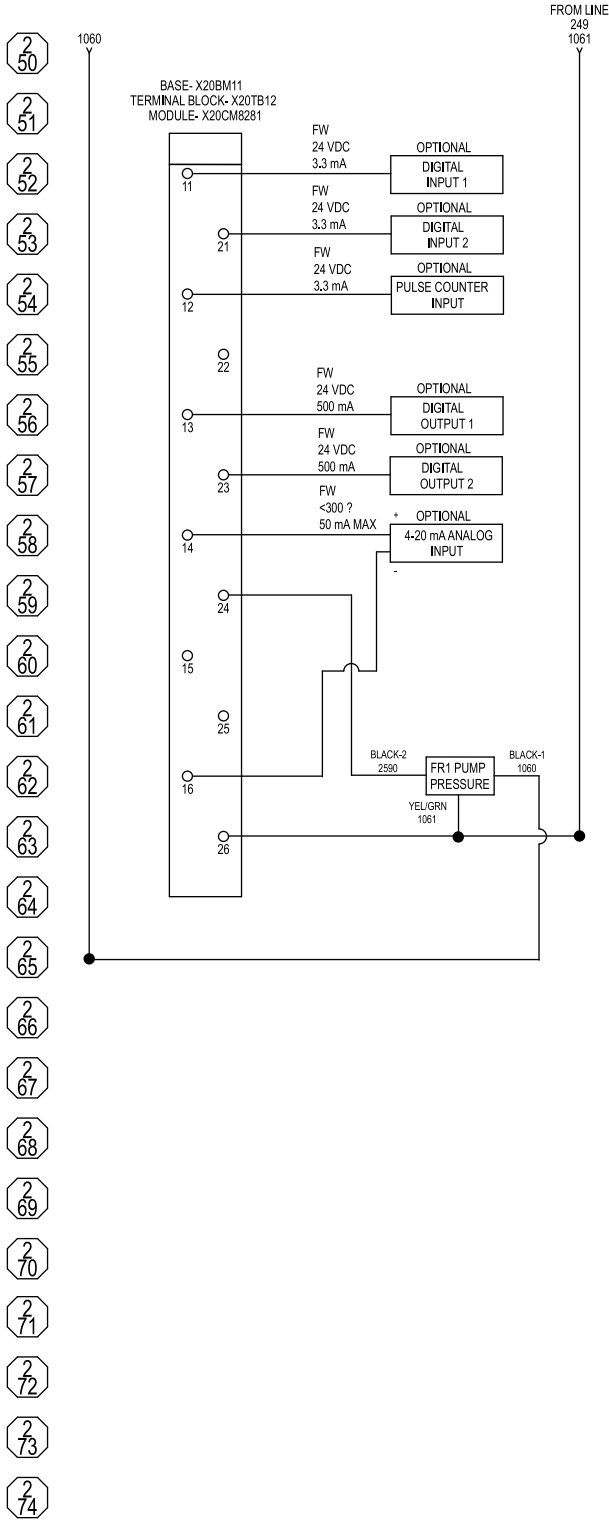

All components marked Optional are not provided with the control panel and must be provided by the installer.

All fittings and connections emerge from the bottom of the control panel.

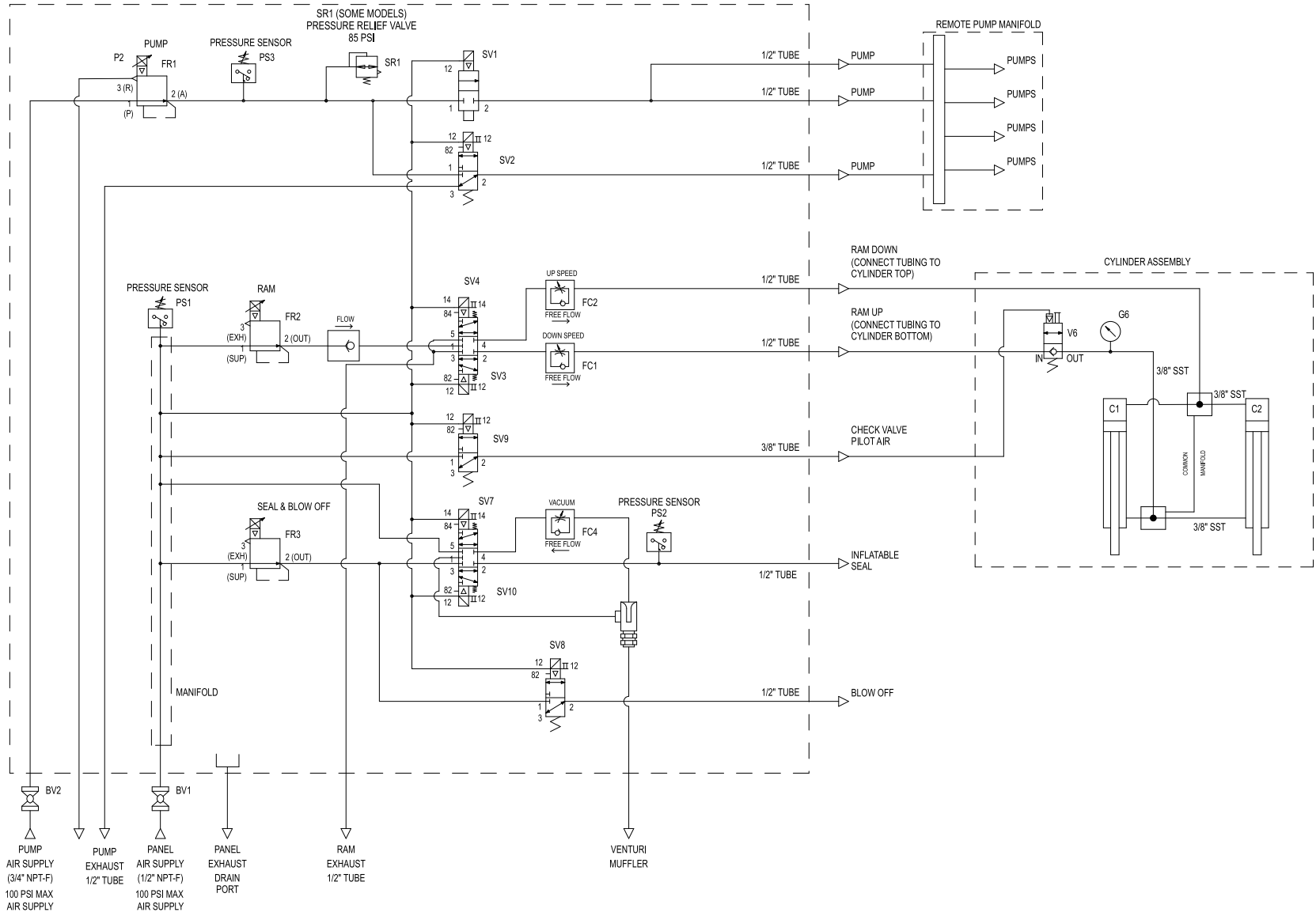

Schematic (electro-pneumatic control)

Technical Data

SaniForce STU		
	US	Metric
Maximum working fluid pressure	See pump manual	
Compressed air requirement	60-100 psi	0.41-0.7 MPa, 4.1-7 bar
Pressure ratio	See pump manual	
Air consumption	See pump manual. Multiply by number of pumps	
Flow rate @ 60 cpm	See pump manual. Multiply by number of pumps	
Fluid displacement	See pump manual. Multiply by number of pumps	
Pump Outlet (See pump manual for pump outlet information)		
Wetted Parts (See pump manual for pump wetted parts)		
300 series stainless steel, buna-n, and polychloroprene or EPDM on the ram plate and seals. <i>See your pump manual for additional wetted parts.</i>		
Control panel		
Enclosure type	4X	
Maximum input air pressure	100 psi	0.7 MPa, 7 bar
Maximum up/down ram pressure	100 psi	0.7 MPa, 7 bar
Maximum seal pressure	18 psi	0.1 MPa, 1.2 bar
Air inlet - air controls	1/2 in npt(f)	
Air inlet - pump	3/4 in npt(f)	
Electrical specifications for electro-pneumatic control panel		
Supply voltage	100-240 VAC	
Phase	1	
Frequency	50/60 Hz	
Maximum current	1.3 A	
No electrical disconnect switch or branch circuit protection provided on the panel.		
Sound data <i>See your pump manual.</i>		

Fluid Temperature Range

NOTICE

Temperature limits are based on mechanical stress only. Certain chemicals will further limit the fluid temperature range. Stay within the temperature range of the most-restricted wetted component. Operating at a fluid temperature that is too high or too low for the components of your pump may cause equipment damage.

Diaphragm/Ball/Seat Material	Stainless Steel Pump Fluid Temperature Range	
	Fahrenheit	Celsius
FKM Fluoroelastomer (FK)	-40°F to 275°F	-40°C to 135°C
Polychloroprene check balls (CW)	0°F to 180°F	-18°C to 82°C
PTFE overmolded diaphragm (PO)	40°F to 180°F	4°C to 82°C
PTFE check balls (PT) or two-piece PTFE/Santoprene diaphragm (PS)	40°F to 220°F	4°C to 104°C
Santoprene (SP)	-40°F to 180°F	-40°C to 82°C

* The maximum temperature listed is based on the ATEX standard for T4 temperature classification.

California Proposition 65

CALIFORNIA RESIDENTS

 **WARNING:** Cancer and reproductive harm — www.P65warnings.ca.gov.

Graco Standard Warranty

Graco warrants all equipment referenced in this document which is manufactured by Graco and bearing its name to be free from defects in material and workmanship on the date of sale to the original purchaser for use. With the exception of any special, extended, or limited warranty published by Graco, Graco will, for a period of twelve months from the date of sale, repair or replace any part of the equipment determined by Graco to be defective. This warranty applies only when the equipment is installed, operated and maintained in accordance with Graco's written recommendations.

This warranty does not cover, and Graco shall not be liable for general wear and tear, or any malfunction, damage or wear caused by faulty installation, misapplication, abrasion, corrosion, inadequate or improper maintenance, negligence, accident, tampering, or substitution of non-Graco component parts. Nor shall Graco be liable for malfunction, damage or wear caused by the incompatibility of Graco equipment with structures, accessories, equipment or materials not supplied by Graco, or the improper design, manufacture, installation, operation or maintenance of structures, accessories, equipment or materials not supplied by Graco.

This warranty is conditioned upon the prepaid return of the equipment claimed to be defective to an authorized Graco distributor for verification of the claimed defect. If the claimed defect is verified, Graco will repair or replace free of charge any defective parts. The equipment will be returned to the original purchaser transportation prepaid. If inspection of the equipment does not disclose any defect in material or workmanship, repairs will be made at a reasonable charge, which charges may include the costs of parts, labor, and transportation.

THIS WARRANTY IS EXCLUSIVE, AND IS IN LIEU OF ANY OTHER WARRANTIES, EXPRESS OR IMPLIED, INCLUDING BUT NOT LIMITED TO WARRANTY OF MERCHANTABILITY OR WARRANTY OF FITNESS FOR A PARTICULAR PURPOSE.

Graco's sole obligation and buyer's sole remedy for any breach of warranty shall be as set forth above. The buyer agrees that no other remedy (including, but not limited to, incidental or consequential damages for lost profits, lost sales, injury to person or property, or any other incidental or consequential loss) shall be available. Any action for breach of warranty must be brought within two (2) years of the date of sale.

GRACO MAKES NO WARRANTY, AND DISCLAIMS ALL IMPLIED WARRANTIES OF MERCHANTABILITY AND FITNESS FOR A PARTICULAR PURPOSE, IN CONNECTION WITH ACCESSORIES, EQUIPMENT, MATERIALS OR COMPONENTS SOLD BUT NOT MANUFACTURED BY GRACO. These items sold, but not manufactured by Graco (such as electric motors, switches, hose, etc.), are subject to the warranty, if any, of their manufacturer. Graco will provide purchaser with reasonable assistance in making any claim for breach of these warranties.

In no event will Graco be liable for indirect, incidental, special or consequential damages resulting from Graco supplying equipment hereunder, or the furnishing, performance, or use of any products or other goods sold hereto, whether due to a breach of contract, breach of warranty, the negligence of Graco, or otherwise.

FOR GRACO CANADA CUSTOMERS

The Parties acknowledge that they have required that the present document, as well as all documents, notices and legal proceedings entered into, given or instituted pursuant hereto or relating directly or indirectly hereto, be drawn up in English. Les parties reconnaissent avoir convenu que la rédaction du présente document sera en Anglais, ainsi que tous documents, avis et procédures judiciaires exécutés, donnés ou intentés, à la suite de ou en rapport, directement ou indirectement, avec les procédures concernées.

Graco Information

For the latest information about Graco products, visit www.graco.com.
For patent information, see www.graco.com/patents.

To place an order, contact your Graco Distributor or call to identify the nearest distributor.

Phone: 612-623-6921 **or Toll Free:** 1-800-328-0211 **Fax:** 612-378-3505

All written and visual data contained in this document reflects the latest product information available at the time of publication.

Graco reserves the right to make changes at any time without notice.
Original Instructions. This manual contains English. MM 3A5416

Graco Headquarters: Minneapolis
International Offices: Belgium, China, Japan, Korea

GRACO INC. AND SUBSIDIARIES • P.O. BOX 1441 • MINNEAPOLIS MN 55440-1441 • USA
Copyright 2018, Graco Inc. All Graco manufacturing locations are registered to ISO 9001.

www.graco.com
Revision L, April 2022