





BE >

BE responsible

Being responsible is our foundation.

We know that we have a responsibility towards the people who are Grundfos, towards the innovative soul of Grundfos as well as towards the surrounding world. Whatever we do, we make sure that we have a firm and sustainable basis for doing it.



THINK >

THINK ahead

Thinking ahead makes innovation possible. We encourage a certain Grundfos way of thinking which is founded upon the belief that everyone must contribute by using his or her judgement and foresight. We are looking for commitment and ideas in every-thing we do in order to make the best solu-tions. We think — and then we act.



INNOVATE >

INNOVATE

Innovation is the essence. It is the innovations that make Grundfos unique. We stand out because of our ability to constantly create new solutions to the ever-changing demands of the pump busi-ness. We meet every challenge and we are never afraid of taking the initiative—we remaining true to our ideals calls for renewal. Innovation is the soul of Grundfos.

APPLICATION OVERVIEW

Pumps for all purposes

Grundfos offers high quality products for efficient, energy-saving pump solutions.



Heating and hot water service systems

Circulator pumps for circulation of hot water in central and district heating systems and circulation in domestic hot water service systems.

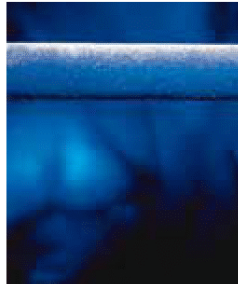

Cooling and air conditioning systems

Circulator pumps for circulation of cold water and other liquids in cooling and air conditioning systems.



Industrial applications

A wide range of multistage pumps for the transfer of water, cooling lubricants, and other liquids in industrial and process systems.



Pressure boosting and liquid transfer

Vertical and horizontal, centrifugal pumps, and pressure boosting systems for liquid transfer and boosting of hot and cold water.

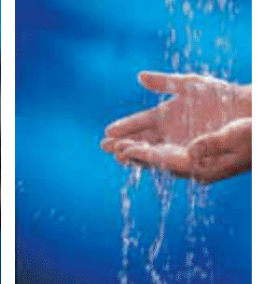

Sanitary

Hygienic end-suction-centrifugal, rotary positive displacement, self-priming and multistage pumps for food, beverage, and pharmaceutical process systems.



Groundwater supply

Submersible pumps for groundwater supply, irrigation and groundwater de-watering.



Domestic water supply

Submersible pumps, jet pumps, multistage centrifugal pumps and compact systems for water supply in homes, gardens, and hobby applications.

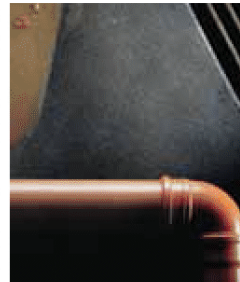

Sewage and wastewater

Drainage, sump, effluent and sewage pumps for a wide range of applications in building services.



Environmental applications

Purpose-built submersible pumps for remedial pumping of contaminated groundwater and for groundwater sampling for water quality analyses.

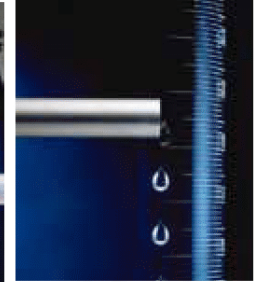

Dosing/Disinfection

Dosing pumps and disinfection generators for water treatment systems, RO, cooling and heating, swimming pools, process industries, food and beverage, water supply and wastewater.



CR-H, CRE-H

Horizontal end-suction multistage pumps

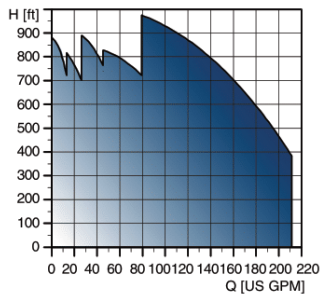

Technical data

Flow, Q: max. 210 gpm
 Head, H: max. 995 ft
 Liquid temp.: -22°F to +248°F
 Working press.: max. 435 psi

Applications

The pumps are suitable for liquid transfer in:

- Pressure boosting
- Industrial processes
- Boiler feed
- Liquid transfer
- Irrigation
- ANSI B73.1 replacement

Features and benefits

- Low profile horizontal design
- Cartridge shaft seal
- Maximized efficiency
- Service-friendly
- Dimensional versions

Optional

- Grundfos baseplate
- Wireless remote control, R100



CR, CRI, CRN

Vertical in-line multistage pumps

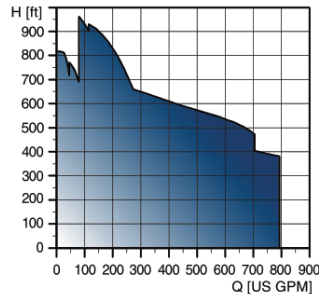

Technical data

Flow, Q: max. 792 gpm
 Head, H: max. 995 ft
 Liquid temp.: -22°F to +248°F
 Working press.: max. 435 psi

Applications

The pumps are suitable for liquid transfer in:

- Washing systems
- Cooling and air conditioning systems
- Water supply systems
- Water treatment systems
- Fire fighting systems
- Industrial plants
- Boiler feed systems

Features and benefits

- Reliability
- High efficiency
- Service-friendly
- Space-saving
- Suitable for slightly aggressive liquids

Optional

- Dry-running protection and motor protection via LiqTec™



CRE, CRIE, CRNE

Multistage centrifugal pumps electronically controlled

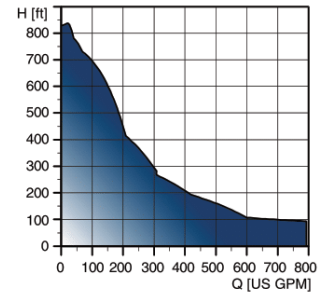

Technical data

Flow, Q: max. 790 gpm
 Head, H: max. 820 ft
 Liquid temp.: -22°F to +248°F
 Working press.: max. 435 psi

Applications

The pumps are suitable for liquid transfer in:

- Washing systems
- Cooling and air conditioning systems
- Water supply systems
- Water treatment systems
- Fire fighting systems
- Industrial plants
- Boiler feeding systems

Features and benefits

- Wide range
- Reliability
- In-line design
- High efficiency
- Service-friendly
- Space-saving
- Many control facilities

Optional

- Wireless remote control, R100



Hydro Multi-E

Multiple packaged pump system

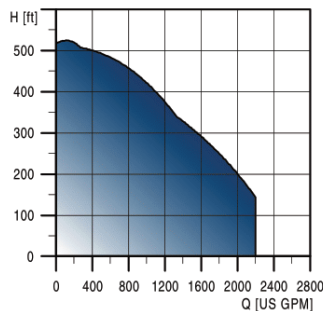

Technical data

Flow, Q (4 pump system): max. 2200 gpm
 Head, H: max. 535 ft
 Liquid temp.: +32°F to +176°F
 Working press.: max. 232 psi

Applications

- Residential/commercial buildings
- Water supply systems
- Industrial applications
- HVAC applications

Features and benefits

- Constant pressure, all variable speed control
- Simple installation
- Low-energy consumption
- Wide range

Optional

- External communication supports other fieldbus protocols such as Modbus, Profibus, LON, BACnet and more.



BoosterpaQ® Hydro MPC

Advanced packaged pump system

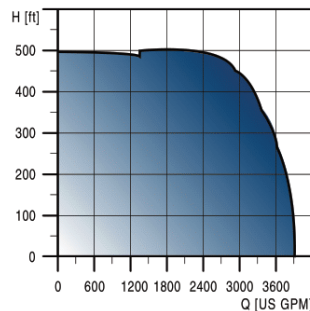

Technical data

Flow, Q (4 pump system): max. 2540 gpm
 Flow, Q (6 pump system): max. 3800 gpm
 Head, H: max. 500 ft
 Liquid temp.: +32°F to +176°F
 Working press.: max. 232 psi

Applications

BoosterpaQ systems are suitable for pressure boosting in:

- Water supply systems
- Irrigation systems
- Water treatment systems
- Fire fighting systems
- Industrial plants
- HVAC systems

Features and benefits

- Constant pressure
- Simple installation
- Low-energy consumption
- Wide range
- Many advanced control functions
- Intuitive control interface

Optional

- Supports other fieldbus protocols such as Modbus, Profibus, LON, BACnet and more.



Hydrosolo-E

Pressure booster system

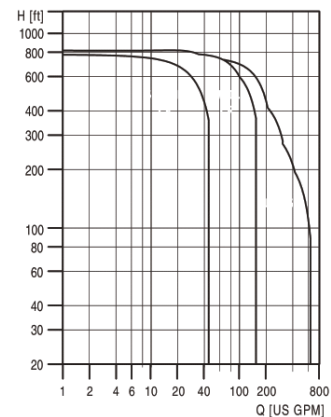

Technical data

Flow, Q: max. 630 gpm
 Head, H: max. 995 ft
 Liquid temp.: -22°F to +250°F

Applications

The pumps are suitable for:

- Transfer and pressure boosting of clean water in houses, cottages, farms, small commercial and residential building
- Pressure boosting in other systems e.g., process water systems and irrigation

Features and benefits

- Eliminates control valves and problematic pressure storage tanks
- Harmonic distortion protection built in
- Lower energy consumption
- Less pump noise
- Easy to set up and operate
- Comprehensive protection of drive, motor and pump equipment
- Reduced maintenance
- Eliminates current in-rushes on the AC line
- Protection from extreme voltage and temperature conditions



SQ

3" submersible pump

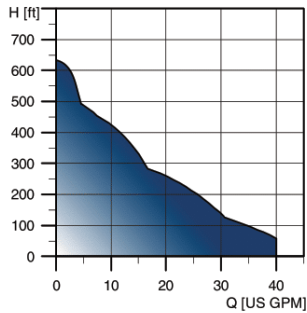

Technical data

Flow, Q: max. 40 gpm
 Head, H: max. 640 ft
 Liquid temp.: +32°F to +104°F
 Instal. depth: max. 500 ft

Applications

The pumps are suitable for:

- Domestic water supply
- Irrigation in horticulture and agriculture
- Groundwater de-watering
- Industrial applications

Features and benefits

- Integrated dry-running protection
- Soft start
- Over, and undervoltage protection
- High-starting torque
- Overload protection

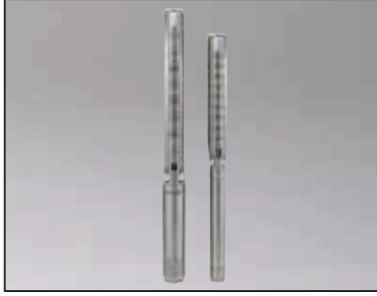

SP

4", 6", 8" and 10" submersible pumps

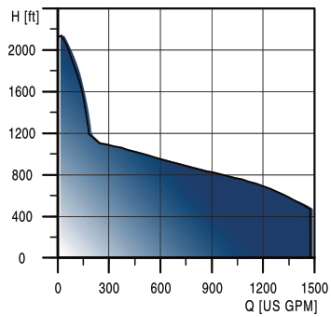

Technical data

Flow, Q: max. 1,400 gpm
 Head, H: max. 2,100 ft
 Liquid temp.: +32°F to +140°F
 Instal. depth: max. 1968 ft

Applications

The pumps are suitable for:

- Groundwater supply to waterworks
- Irrigation in horticulture and agriculture
- Groundwater de-watering
- Pressure boosting
- Industrial applications
- Domestic water supply

Features and benefits

- High efficiency
- Stainless steel components provide long service life
- Motor protection via CU 3
- Variable frequency drive compatible motors

Optional

- Motor protection via MP 204
- Performance data can be monitored via CU 3/R100/PC Tool MP 204



INNOVATION INSIDE



The Inside Story

› Motor

Grundfos provides many motor solutions depending upon the application and demand. In addition, Grundfos makes its own motors to ensure maximum performance. The ML motors* are remarkably quiet and highly efficient. They are also available in the self-regulating MLE configuration, featuring an integrated variable frequency drive.

› Cartridge seal

The specially designed cartridge seal increases reliability, ensures safe handling and enables easy service and access.

› Shaft seal solutions

The cartridge shaft seal configuration comes in a wide choice of materials. It is available in flushed seal and double seal configurations and can handle temperatures from -40°F to +356°F (-40°C to +180°C).

› Connection options

The Grundfos CR can be connected to any piping system.

› Dry-running sensor

The patented Grundfos LiqTec™ system eliminates the risk of breakdowns due to dry running. If there is no liquid in the pump, the LiqTec will immediately stop it.

› High-performance hydraulics

Pump efficiency is maximized by state-of-the-art hydraulic design and carefully crafted production technology.

› Durable bearings

The CR bearings are remarkably long-lived thanks to hard-wearing materials and a wide range of options for difficult liquids.

› Material options

The CR is available in four different materials: AISI 304/cast iron, stainless steel AISI 304, stainless steel AISI 316, and titanium.

› Wide range of sizes

The CR comes in 11 hydraulic sizes and hundreds of pressure sizes, ensuring that you can always find exactly the right pump for the job.

To many, innovation is just a buzzword. At Grundfos, innovation is an integrated feature of all our products. After all, it's what's inside that matters.

* Grundfos ML motors are not available in Canada.

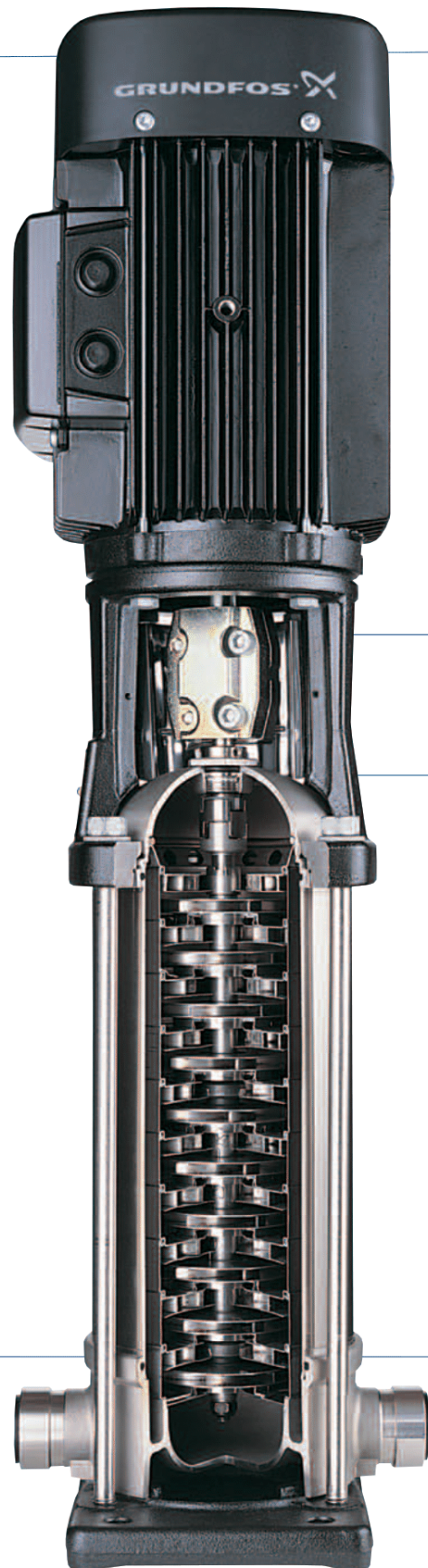



The **complete** Grundfos CR range:

The last word in multistage pump technology

Grundfos was the first pump manufacturer ever to create a multistage in-line pump. Known as the CR pump, this innovative design has inspired followers all over the world. Even so, continuous development and innovation ensure that the Grundfos CR remains unmatched.

The CR of today reflects the needs and requirements of customers worldwide. We know this, because we asked you first. All development work at Grundfos is carried out with the end-users in mind; never for its own sake. The latest improvements provide:

Superior reliability

Unmatched cost efficiency

The most extensive range on the market

The new generation of Grundfos CR pumps features a full range of sizes and limitless scope for combinations to suit your specific needs. At Grundfos, innovation is about making things better. And we focus our effort where it matters: **inside.**

RELIABILITY

Reliability in real life

The CR is well known for its reliability. And rightly so. The CR design has all the durability that customers expect from a high-quality multistage pump — and then some. We have added unique features to ensure unsurpassed reliability: dry-running protection, a unique cartridge seal, and a full-titanium variant.

The virtually endless range of standard and customized CR pumps means that you can find the right CR to provide reliable operation for most any requirement.

Superior dry-running protection

Dry running is the most common cause of pump failure. In most pumps, the shaft seal and bearings will burn out almost immediately if liquid stops flowing in the pump.

The Grundfos CR is different. As part of our constant dedication to innovation, we have tested new and alternative materials to bring you the best possible solution. This means that we can equip CR



pumps with a shaft seal and bearing system that can withstand extreme heat and friction for longer periods of time. This makes them more forgiving if the pump does run dry.

Grundfos LiqTec checks for liquid 24 hours a day

For those who need to avoid dry-running altogether, the Grundfos LiqTec is the answer. Available with all CR pumps, the LiqTec is plug-and-play technology at its very best. Ever vigilant, the LiqTec constantly checks that there is liquid in the pump. If there isn't, it stops the pump immediately.

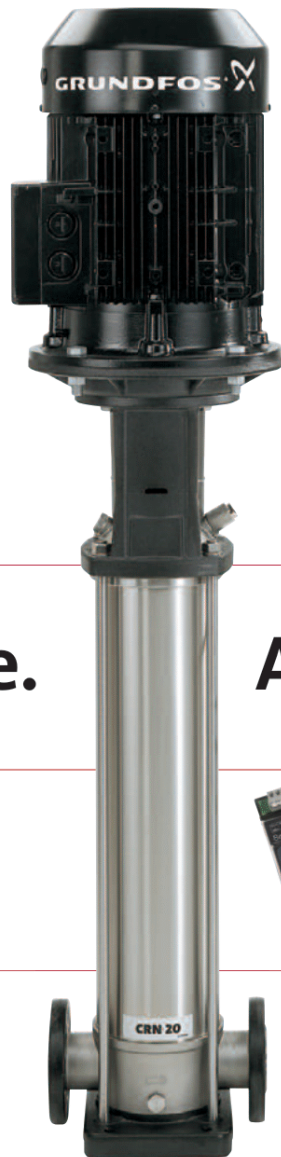

It's reliable.

And we can prove it.

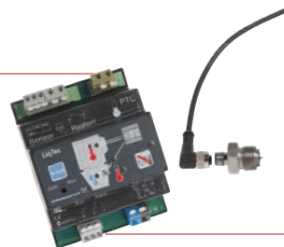

In the event of dry running, the Grundfos LiqTec™ immediately shuts down the pump before damage occurs

EFFICIENCY

Reduce the **real costs**

Electricity is the most expensive part of any pump—a simple fact that is often overlooked when pumps and prices are compared.

It may be surprising that the purchase price and maintenance costs account for less than 15% of the total lifetime cost of a pump. Electricity accounts for a staggering 85% or more of the total costs. So if you want to save money, that's where you should look.

The Grundfos CR makes a real difference; the table below shows just how much electricity CR can save you annually.

These savings will continue for years and years – for every pump you own. Its low lifetime cost makes a CR pump a very sensible investment.

The table at right shows the unique efficiency of the Grundfos CR range.



CR pump efficiency

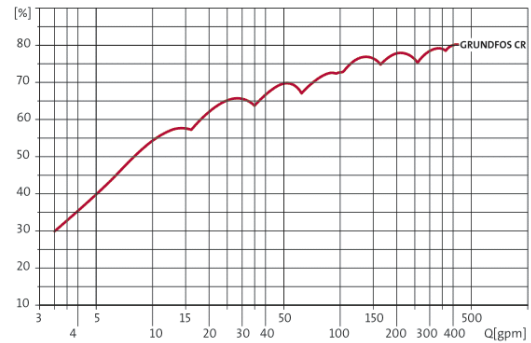

Let's talk money.

How much difference does a CR make?

Application type	Typical duty point	Operating hours per day	Average kWh reduction per year with CR
Water supply	350 gpm @ 85 psi	24 hours	18,500 kWh
Boiler feed	175 gpm @ 225 psi	15 hours	12,700 kWh
Water treatment	10 gpm @ 225 psi	15 hours	3,200 kWh
Industrial washing and cleaning	25 gpm @ 225 psi	5 hours	1,600 kWh
General industrial pump task	25 gpm @ 145 psi	10 hours	2,200 kWh

Efficiency saves money year after year

Getting the best possible overall efficiency out of your pump makes financial sense. The narrow interval between CR pump sizes allows you to eliminate the efficiency drop associated with over-sized pumps.

By minimizing the difference between pump capacity and the required pressure and volume, you get a pump which runs as close to its optimum duty point as possible. That makes it as cost-efficient as possible.

The result of years of Grundfos development work is a 10% increase in pump efficiency. This translates into a power reduction of 15-20% for the CR pumps. When pumps are in operation many hours a day, such improvements provide substantial savings – year in and year out.

Good things come in threes

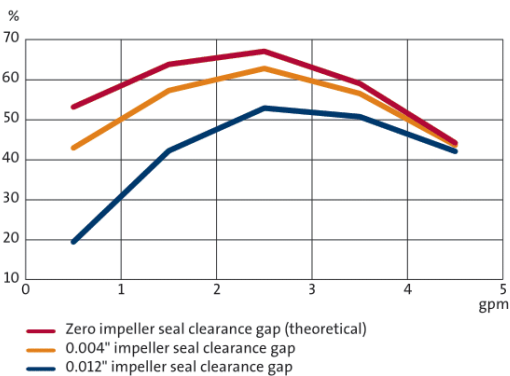

Grundfos achieved a 10% increase in pump efficiency through three innovative improvements to the impeller and seal. These improvements also mean a smaller motor can often be used to power the pump—and that equals savings on both initial investment and running costs.

1



Internal leakage caused by pressure differentials within the pump was minimized. Tests have shown that an impeller seal clearance gap of just 0.016" between the impeller and the chamber causes a 5% drop in efficiency. When liquid seeps out into the pump, precious energy is wasted on circulating that liquid. Grundfos uses a floating seal ring between chambers, providing a nearly perfect seal.

2

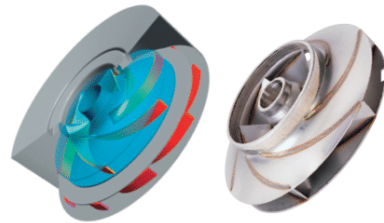

An enhanced impeller design reduces eddy flow and friction losses. We developed a highly specialized laser-welding technology which brings you impellers of truly superior design and construction.

3

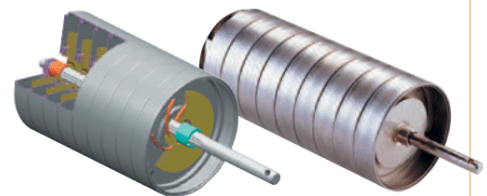

State-of-the-art production technology guarantees the best possible results and gives the CR pumps the final edge. At Grundfos, we develop our own tools and processes to ensure a perfect match between what we want to do and the tools we use to do it. The final outcome is products with near-perfect geometries and tolerances, reflecting the care that has gone into the research and development stages.

The CR range has the right pump for the job

Choosing the right pump can be difficult. It may be easy enough to find a pump that will do the job, but it gets trickier when you want an *exact* match. There are many good reasons to avoid over-capacity, with energy conservation at the top of the list. The CR range lets you choose pumps which exactly match your system demands.

CR is available in 11 hydraulic sizes, four basic materials and about one million configurations. You can get CR pumps with magnetic drives, with air-cooled shaft seal chambers, with double shaft seals, etc. Special CR pumps are available for high-pressure performance, for aggressive liquids, and much more. And there is a CR pump for almost any liquid you could possibly want to pump.

The CR range is available in four different basic materials:



CR
AISI 304 stainless steel
with a cast iron top and base



CRI
AISI 304 stainless steel
throughout



CRN
AISI 316 stainless steel
throughout



CRT
Titanium
throughout

What can you pump with a CR?

Aggressive or corrosive liquids	Seawater, hypochlorites, hydrochloric acid, ferric chloride, nitric acid, chromic acid, phosphoric acid
Abrasive liquids	Metasilicate-containing cleaning agents, abrasive alkaline cleaners, phosphates
Toxic or explosive liquids	Trichlorethylene, toluene, petroleum, ethyl alcohol, methyl alcohol
High-viscosity liquids	Glycols, carboxylates (for cooling), lubricating oils, rapeseed oil
Hardening liquids	Water-based paint, glue, vegetable oils
Crystallizing liquids	Glycol additives, naphthalene, sugar products (e.g. dextran), salts
High pressures	Water treatment, cleaning/washing
Extreme temperatures	Petrochemicals, oils, boiler feed, secondary coolants

Motor options

- Special supply voltages and protection methods
- Non-standard motor size (e.g. for pumping high or low viscosities)
- Explosion-proof, dust ignition-proof
- For extreme temperatures, humidity, or altitudes
- Specific approval requirements
- Multi-plug (Harting® Plug)
- Non-Grundfos motor

Shaft seal options

- Chemical resistant O-rings for aggressive chemicals
- Special seal face or LiqTec™ run-dry sensor to protect against dry running
- Balanced high-pressure shaft seal for 362 to 580 psi
- Air-cooled shaft seal system for extreme high temperatures
- Double shaft seal with pressure chamber for pumping explosive or poisonous liquids

Pump options

- Horizontal position for height limitations
- Low NPSH pumps
- High-pressure pumps
- Special surface treatments or approvals
- Pumps for extreme temperatures
- Silicone-free pumps
- Corrosion-free titanium CRT pumps for sea water or highly corrosive liquids
- Wide variety of connections

The Grundfos CRE: Ultimate solutions

Variable-speed motor

To accommodate the many situations where the required flows and pressures vary considerably over time, CRE pumps have a variable-speed motor that continually adapts pump performance to match current conditions. CRE pumps combine the very best of pump technology with sophisticated motors developed by Grundfos with optimum efficiency in mind.

Do you need constant pressure? Constant differential pressure? Stable pH levels? Specific temperatures? Carefully timed operation? Grundfos CRE can give you all this and much more.

Communication options

CRE can be remote-controlled and/or linked to management systems of your choice for perfect interaction. CRE offers unique possibilities of monitoring the performance and the result of the performance as well as controlling the pump performance. Or both in the same solution.

Ultimate efficiency

CRE variable speed pumps yield constant benefits. With their ability to change speed to suit the demand, you never spend energy generating pressure you do not require. The electronically controlled motors complement the already highly efficient Grundfos CR pumps, saving even more energy and contributing to a very low total cost of ownership.

The entire CR range can be fitted with a variable speed motor, meaning that you can enjoy the benefits of the CRE model regardless of what your other requirements may be.

CRE pumps combine highly efficient Grundfos CR pumps with our variable-speed motors.

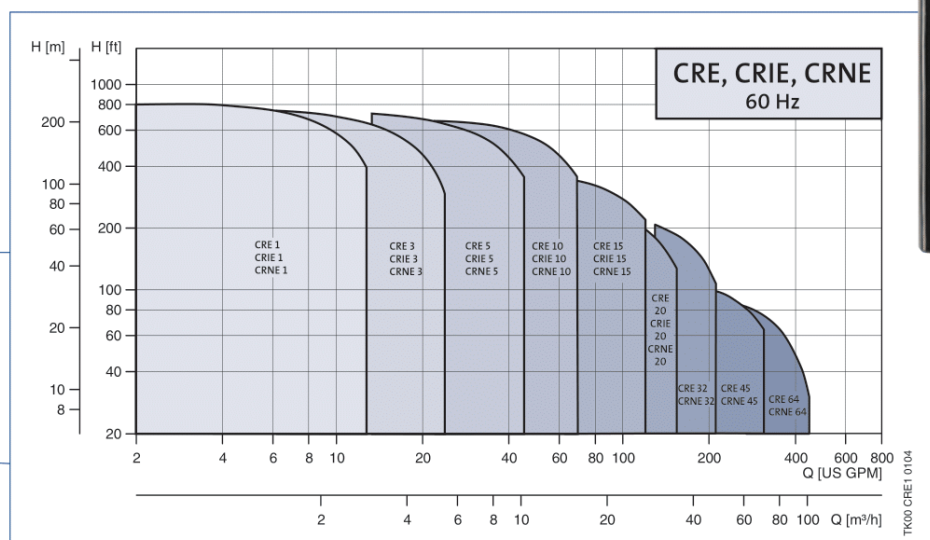

PERFORMANCE CURVES AND TECHNICAL DATA

CR Performance Range

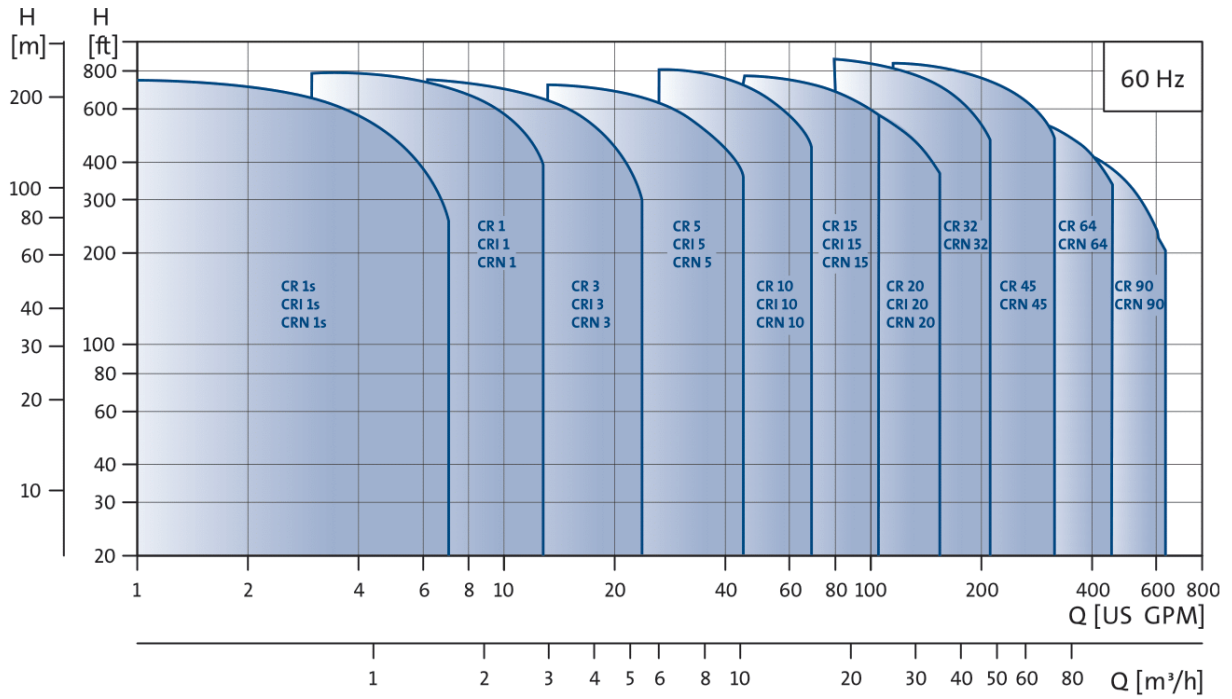

CR Efficiency

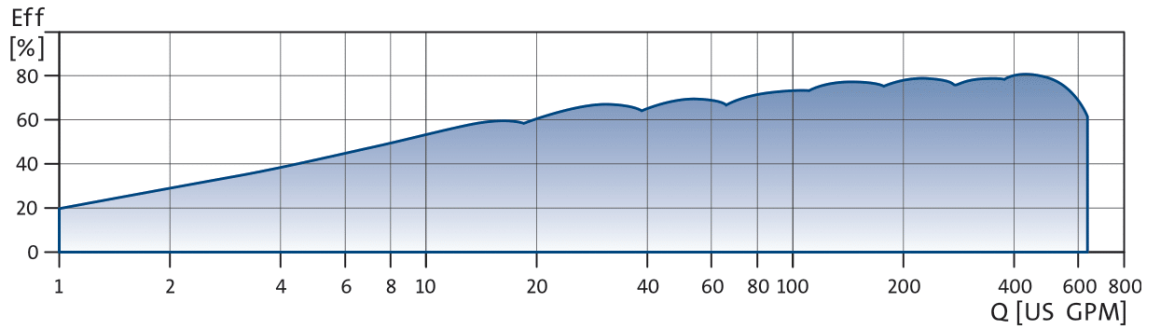

CR Product Range

Range	CR 1s	CR 1, CRE 1	CR 3 CRE 3	CR 5 CRE 5	CR 10 CRE 10	CR 15 CRE 15	CR 20 CRE 20	CR 32 CRE 32	CR 45 CRE 45	CR 64 CRE 64	CR 90	
Nominal flow rate (US GPM)	4.5	8.5	15	30	55	95	110	140	220	340	440	
Temperature range (°F)	-4 to +250							-22 to +250				
Temperature range (°F) - on request	-40 to +356							-40 to +356				
Max. working pressure (psi)	360	360	360	360	360	360	360	435	435	360	360	
Max. working pressure (psi) - on request	-	725	725	725	725	725	725	580	580	580	580	
Max. pump efficiency (%)	35	49	59	67	70	72	72	76	78	79	80	
CR pumps:												
CR: Flow range (US GPM)	0.5 - 5.7	1 - 12.8	1.5 - 23.8	3 - 45	5.5 - 70	9.5 - 125	11 - 155	14 - 210	22 - 310	34 - 450	44 - 630	
CR: Max. pump pressure (H[ft])	760	790	790	780	865	800	700	995	940	565	595	
CR: Motor power (HP)	1/3 - 2	1/3 - 3	1/3 - 5	3/4 - 71/2	3/4 - 15	2 - 25	3 - 25	3 - 40	71/2 - 60	71/2 - 60	15 - 60	
CRE pumps:												
CRE: Flow range (US GPM)	-	0 - 12.8	0 - 23.8	0 - 45	0 - 70	0 - 125	0 - 155	0 - 210	0 - 310	0 - 450	-	
CRE: Max. pump pressure (H[ft])	-	790	790	780	665	390	270	240	120	100	-	
CRE: Motor power (HP)	-	1/3 - 3	1/3 - 5	3/4 - 71/2	3/4 - 10	2 - 10	3 - 10	3 - 10	71/2	71/2	-	
Version:												
CR, CRE: Cast Iron and stainless steel AISI 304	●	●	●	●	●	●	●	●	●	●	●	
CR1, CRE1: Stainless steel AISI 304	●	●	●	●	●	●	●	-	-	-	-	
CRN, CRNE: Stainless steel AISI 316	●	●	●	●	●	●	●	●	●	●	●	
CRT, CRTE: Titanium	-	-	CRT 2 CRTE 2	CRT 4 CRTE 4	CRT 8 CRTE 8	CRT 16 CRTE 16	-	-	-	-	-	
CR, CRE pipe connection:												
Oval Flange (NPT)	1"	1"	1"	1 1/4"	2"	2"	2"	-	-	-	-	
Oval Flange (NPT) - on request	1 1/4"	1 1/4"	1 1/4"	1"	1 1/2"	2 1/2"	2 1/2"	-	-	-	-	
ANSI Flange Size	1 1/4"	1 1/4"	1 1/4"	1 1/4"	2"	2"	2"	2 1/2"	3"	4"	4"	
ANSI Flange Size - on request	-	-	-	-	-	-	-	3"	4"	5"	5"	
ANSI Flange Class	250 lb.	250 lb.	250 lb.	250 lb.	250 lb.	250 lb.	250 lb.	125/250 lb.	125/250 lb.	125/250 lb.	125/250 lb.	
CR1, CRE1 pipe connection:												
Oval Flange (NPT)	1"	1"	1"	1 1/4"	2"	2"	2"	-	-	-	-	
Oval Flange (NPT) - on request	1 1/4"	1 1/4"	1 1/4"	1"	1 1/2"	-	-	-	-	-	-	
ANSI Flange Size	1 1/4"	1 1/4"	1 1/4"	1 1/4"	2"	2"	2"	-	-	-	-	
ANSI Flange Class	300 lb.	300 lb.	300 lb.	300 lb.	300 lb.	300 lb.	300 lb.	-	-	-	-	
Clamp coupling (NPT) - on request	1", 1 1/4"	1", 1 1/4"	1", 1 1/4"	1", 1 1/4"	1 1/2", 2"	1 1/2", 2"	2", 2 1/2"	-	-	-	-	
Union (NPT ext. thread) - on request	2"	2"	2"	2"	-	-	-	-	-	-	-	
CRN, CRNE pipe connection:												
PJE (Victaulic)	1 1/4"	1 1/4"	1 1/4"	1 1/4"	2"	2"	2"	-	-	-	-	
PJE (Victaulic) - on request	-	-	-	-	-	-	-	3"	4"	4"	4"	
ANSI Flange Size	1 1/4"	1 1/4"	1 1/4"	1 1/4"	2"	2"	2"	2 1/2"	3"	4"	4"	
ANSI Flange Size - on request	-	-	-	-	-	-	-	3"	4"	4"	4"	
ANSI Flange Class	300 lb.	300 lb.	300 lb.	300 lb.	300 lb.	300 lb.	300 lb.	150/300 lb.	150/300 lb.	150/300 lb.	150/300 lb.	
Clamp coupling (NPT) - on request	1", 1 1/4"	1", 1 1/4"	1", 1 1/4"	1", 1 1/4"	1 1/2", 2"	1 1/2", 2"	2", 2 1/2"	-	-	-	-	
Union (NPT ext. thread) - on request	2"	2"	2"	2"	-	-	-	-	-	-	-	
CRT pipe connection:												
PJE coupling (Victaulic)	-	-	1 1/4"	1 1/4"	2"	2"	-	-	-	-	-	
ANSI Flange Size - on request	-	-	-	-	2"	2"	-	-	-	-	-	

- Available
- Not available



**Grundfos submersible pumps
– the complete solution**

Grundfos

Submersible Pumps

– designed for longevity and efficiency

➤ Wide Range of Sizes

Grundfos offers a complete range of submersible pumps and motors to fit virtually any application, with flow rates of 0 - 1100 gpm

➤ State-of-the-art Hydraulics

Pump efficiency is maximized by constant improvement of the high-performance hydraulic design, and precise manufacturing process

➤ 100% High-grade Stainless Steel

Rugged stainless steel construction inside and out resists corrosion and attack from aggressive liquids

➤ Wear-resistant Design

Designed to flush abrasive particles from the pump, and made from stainless steel to resist wear caused by abrasives

➤ Motors

Grundfos manufactures it's own line of quality submersible motors in a broad variety of sizes. With the same stainless steel construction and quality design as our pumps, Grundfos can provide the complete solution for your submersible pumping needs

➤ Motor Controls and Protection

Available controls to protect the motor against burnout and dry-running, plus the ability to monitor the system allowing the user to optimize settings



Reduce your operating costs

The total cost of owning and operating a pump over its entire lifespan covers much more than just the initial cost – it covers the total sum of the Life Cycle Costs of the pumping system.

Electricity is the most expensive part of any pump – a fact that is often overlooked when pumps and prices are compared. It maybe surprising that the purchase price and maintenance costs account for less than 15% of the total lifetime cost of a pump. Electricity accounts for a staggering 85% or more of the total costs. If you want to save money, that's where you should look.



Typical lifetime cost-split for a groundwater installation

Simple calculations will demonstrate that increased pump efficiency translates into major, long-term savings. Example: Pumping 450 gpm at a head of 250 ft over 10 years, operating 8 hours a day at an energy cost of \$0.10/kWh – a savings of approximately \$12,000 can be achieved by choosing a pump with a 10% higher efficiency rate.

- Initial cost 5%
- Maintenance cost 10%
- Energy cost 85%

Grundfos WinCAPS for an optimum system selection

It all starts with the selection of the pumping system. In order to get the full benefit of the more than \$55 million that Grundfos spends on research and development every year, actual installation conditions must be fully analyzed and the most effective pumping system selected to match those conditions.

Grundfos WinCAPS is a highly advanced software tool designed to help our customers assess wire-to-water efficiency and to compare Life Cycle Costs between alternative pumping solutions.



6, 8 and 10-Inch Submersibles

Grundfos large submersible pumps are designed to reduce operating costs and improve efficiencies. The new high efficiency line is designed to deliver during periods of high demand with better efficiencies and fewer losses, to reduce your overall “cost of ownership”.

Built with the same high-quality, corrosion-resistant stainless steel components as other Grundfos groundwater products, these pumps feature a state-of-the-art impeller design which allows for outstanding performance at depths over 2000 feet.

Grundfos 6”, 8” and 10” submersibles are supplied with a rugged Grundfos submersible motor. Manufactured of stainless steel, the two units together result in a quality pumping unit built to last.



Internal leakage caused by pressure differentials within the pump was minimized. Tests have shown that an impeller seal clearance gap of just 0.4 mm between the impeller and the chamber causes a 5% drop in efficiency. When liquid seeps out into the pump, precious energy is wasted on circulating that liquid. Grundfos uses a floating seal ring between chambers, providing a nearly perfect seal.

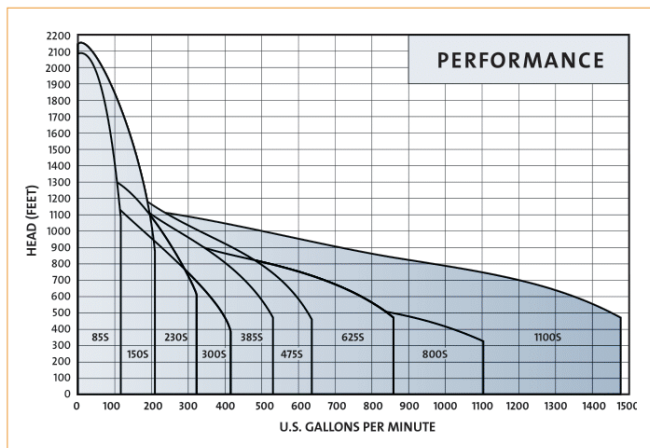

4-Inch Submersibles

Grundfos' 4" submersibles feature corrosion-resistant stainless steel construction and are designed to provide years of trouble-free performance.

With built-in sand bearing protection, the 4" submersible can handle the sandy conditions often found in domestic wells. Built-in, jam-free check valves and special upthrust protection guarantee smooth running, fail-safe operation. A user friendly cable guard aids in ease of installation.

Grundfos 4" submersibles are supplied with a rugged Grundfos submersible motor manufactured of stainless steel. The two units together result in a quality pumping unit built to last.

Radial Thrust Top Bearing handles sand and increases pump life.



State-of-the-art production technology guarantees the best possible results and gives the SP pumps the final edge. At Grundfos, we develop our own tools and processes to ensure a perfect match between what we want to do and the tools we use to do it. The final outcome is products with near-perfect geometries and tolerances, reflecting the care that has gone into the research and development stages.

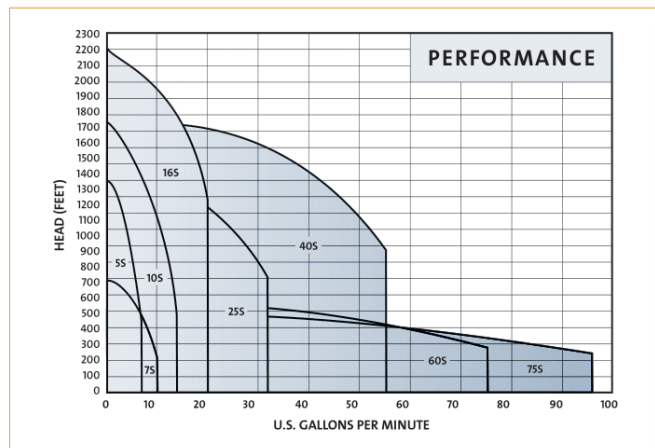

3-Inch SQ Submersibles

Grundfos 3" SQ pumps combine state-of-the-art design with rugged, quality construction. Designed to go into the same applications as standard 4" pumps, SQ's light weight and small size make for fast, easy installation, especially in less-than ideal wells. With a host of advanced features, Grundfos' 3" SQ pumps set a new standard for what a submersible pump should be.

By combining advanced electronics with permanent-magnet motors, we are now able to control and communicate with pumps in ways never before possible. Some features that come out of this combination are, Soft-Start and integrated Dry-Run Protection.

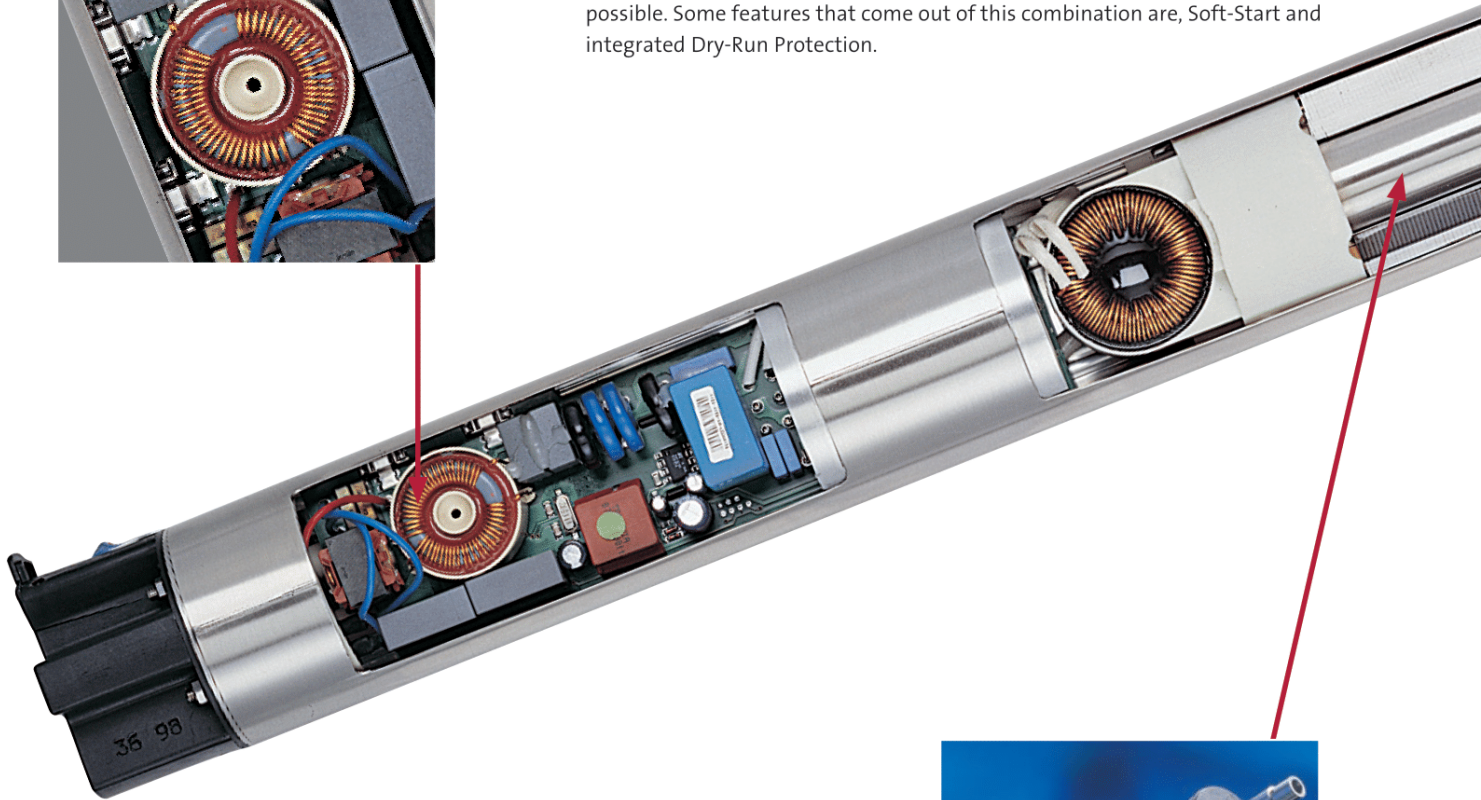
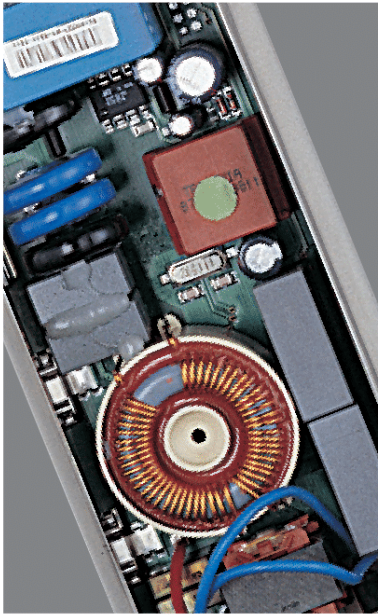

The SQ and SQE motors are based on a permanent-magnet rotor which produces high efficiency output within a wide load range. Other benefits include reduced heat production and start-up torques comparable to 3-phase motors, in a simple-to-install 2-wire format



After-Sales Service Options

1. Extensive spare parts kits availability with service manuals, installation guides, and tools.
2. Factory-authorized service centers in Canada, Mexico, and the United States.
3. Factory service at one of our sales locations in:

Apodaca, N.L. Mexico • Oakville, Ontario, Canada
Fresno, California, USA • Allentown, Pennsylvania, USA



WE'RE ALL ABOUT EXPERIENCE.

1300 255 786 | allpumps.com.au



CELEBRATING

50

YEARS OF EXPERIENCE

**EXPERIENCE INNOVATIVE
THINKERS AND PRODUCTS**



ALL ABOUT EXPERIENCE

allpumps.com.au

1300 255 786 | sales@allpumps.com.au