

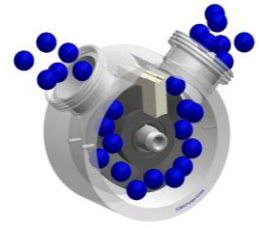

SCN25 SOMA SINUS SODIAL®



ADVANTAGES AND BENEFITS

- Each pump will be individually sized and fitted with the most economical parts
- Gentle transfer especially when fragile particles are pumped
- Suitable for low and high viscous products
- Low pulsation while operating
- No foaming of the product when it is pumped
- Heating / cooling available
- Simple maintenance in plant



TECHNICAL DATA

Performance:

- Capacity: max. 18.000 l/h
- Pressure: max. 15 bar
- Speed: max. 600 rpm
- Temperatur: max. 180°C
- CIP / SIP capability
- 0,45 liter per revolution
- Particle Size: max.30 mm
- Suction Power: -0,85 bar
- Viscosity: 1cps – 9 Mio. cps

Nozzles available:

- Flange
- German Milk Fitting DIN 11851
- Tri-Clamp
- RJT
- SMS

Certification:

- Food and Drug administration (FDA)
- EG 1935-2004
- ATEX
- 3.1 Stainless Steel





SCN25 SOMA SINUS SODIAL®



DIMENSIONAL DRAWING

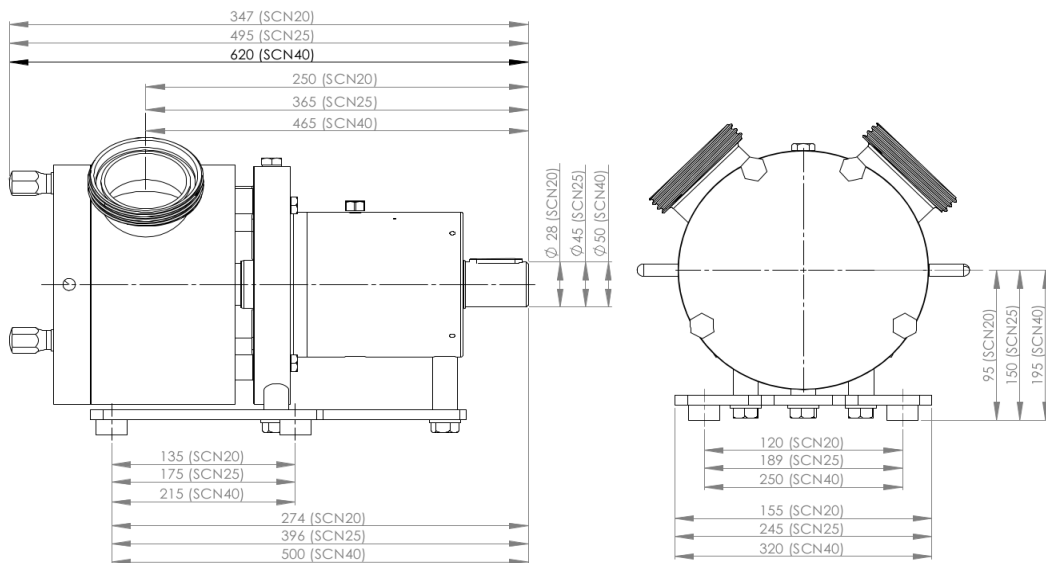

NOZZLE ORIENTATION

