

Submersible Resin Made Pumps

VANCS

PU / PN / PSF / PLS / TM / OM SERIES



**Lightweight, Durable and Corrosion-resistant
Suitable for a Wide Variety of Applications**

VANCS



SUBMERSIBLE RESIN MADE PUMPS

The VANCS-series from Tsurumi features compact, lightweight submersible pumps made of resin, stainless steel and titanium. They are easy to handle, durable and tough against corrosion, owing to carefully selected part-specific resins that deliver higher levels of durability and anti-corrosion performance than what can be attained with simple resin pumps.

The VANCS-series pumps are versatile line pumps that can be used to drain sewage, wastewater, rainwater and seawater. Moreover, because of their compact size, they can be easily installed in tight spaces including inside of septic tanks, small-sized wastewater treatment plants and kitchen wastewater traps in homes and office buildings. Additionally, since they use food grade liquid paraffin as lubricating oil, the pumps are safe and fish-friendly, which opens the door to their use for water circulation, waterfalls and other water features in carp/koi ponds and fish farms. And, this is but a small sample of the wide-ranging applications of the VANCS-series pumps.

The VANCS-series comes in a diverse lineup of discharge bores ranging from 40 to 80 mm and motor outputs of 0.15 to 3.7 kW, as well as a number of models that not only run on single- or three-phase motors but also offer automatic and auto-alternation operation. Plus, the pumps are compatible with Tsurumi's guide rail fitting device that facilitates installation and maintenance.

Though compact in size, the VANCS-series pumps come loaded with a host of time-tested and proven original technologies including an anti-wicking cable, motor protector, dual inside mechanical seals with silicon carbide face and Oil Lifter.

As a pioneer of the resin pump, Tsurumi has dedicated years of research to improving pump durability and maintainability, and perfecting designs for continuous duty. The end result is a vast and deep selection of reliable, durable and sound quality products that users can trust.

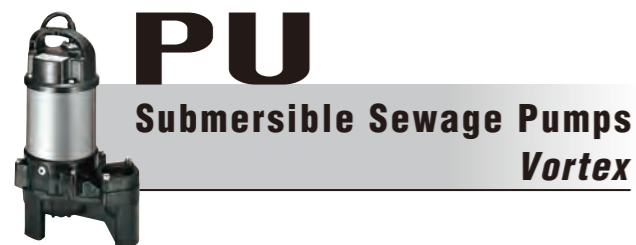

Selection Table

Category	Series	Discharge Bore mm	Impeller	Model	Motor Output kW						
					0.15	0.25	0.4	0.75	1.5	2.2	3.7
Sewage	PU	40 – 80	Vortex	Standard Automatic Auto-alternation	[Bar chart showing availability for 0.15, 0.25, 0.4, 0.75, 1.5, 2.2, 3.7 kW]						
Wastewater	PN	40 – 80	Vortex	Standard Automatic Auto-alternation	[Bar chart showing availability for 0.25, 0.4, 0.75, 1.5, 2.2, 3.7 kW]						
Wastewater -High Head-	PSF	40 – 65	Closed	Standard Automatic Auto-alternation	[Bar chart showing availability for 0.25, 0.4, 0.75, 1.5, 2.2, 3.7 kW]						
Wastewater -Horizontal-	PLS	50	Vortex	Standard	[Bar chart showing availability for 0.15, 0.25, 0.4, 0.75, 1.5, 2.2, 3.7 kW]						
Seawater	TM	40 – 80	Vortex	Standard Automatic	[Bar chart showing availability for 0.25, 0.4, 0.75, 1.5, 2.2, 3.7 kW]						
Wastewater -Economic-	OM	32	Vortex	Standard Automatic	[Bar chart showing availability for 0.15, 0.25, 0.4, 0.75, 1.5, 2.2, 3.7 kW]						

Model Number Designation

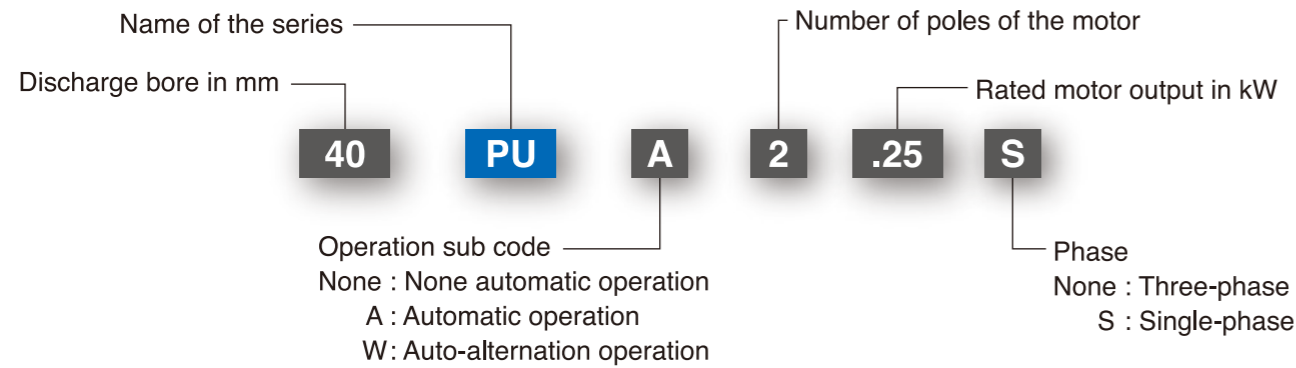

Guide Rail Fitting System (PU, PN, PSF series only)

The TOK type guide rail fitting system connects the pump to and from the piping easily just by lowering and hoisting the pump, allowing easy maintenance and inspection without the need to enter the sump. Made of high-quality resin, the TOK is designed for lightweight, small to middle sized pumps.

Accessories

- Duckfoot Bend
 - Guide Hook
 - Guide Support with Bolts & Nuts
 - Lifting Chain with Shackles
- (4m for TOK4-P, 5m for TOK2-65 / 65T)

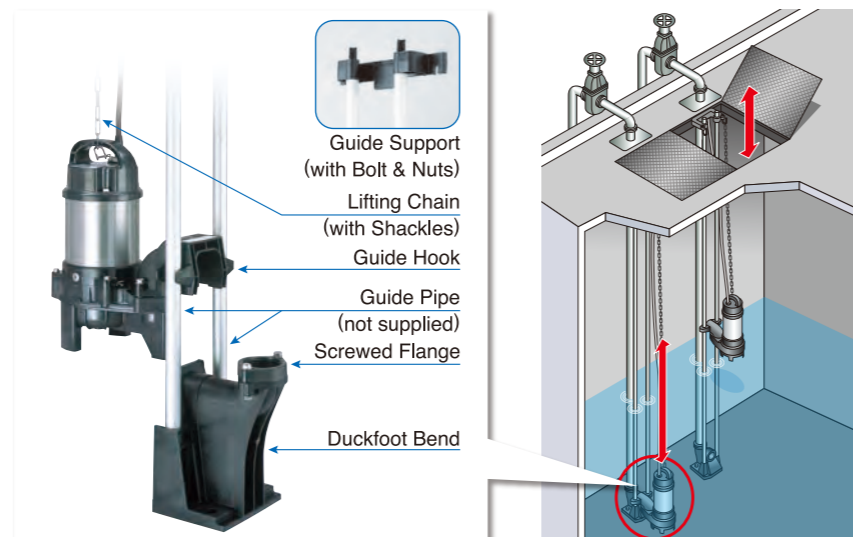
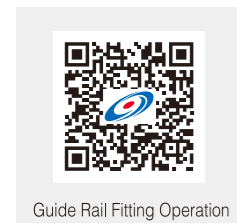

Automatic & Auto-alternation Model

Tsurumi offers an automatic alternation system by a duplex pump comprising an automatic model “A” unit and auto-alternation model “W” unit. The “A” unit is a stand-alone automatic pump and the “W” unit is a pump that has an alternating circuitry. They operate automatically in response to the change in water levels.

Automatic Model

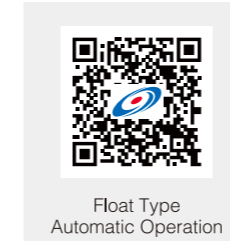

*Refer to page 17 for the operation of cylindrical float type.



Float Type (PU, PN, PSF, TM)



Cylindrical Float Type (OM)

Auto-alternation Model



(PU, PN, PSF)

How the Auto-alternation Model Works

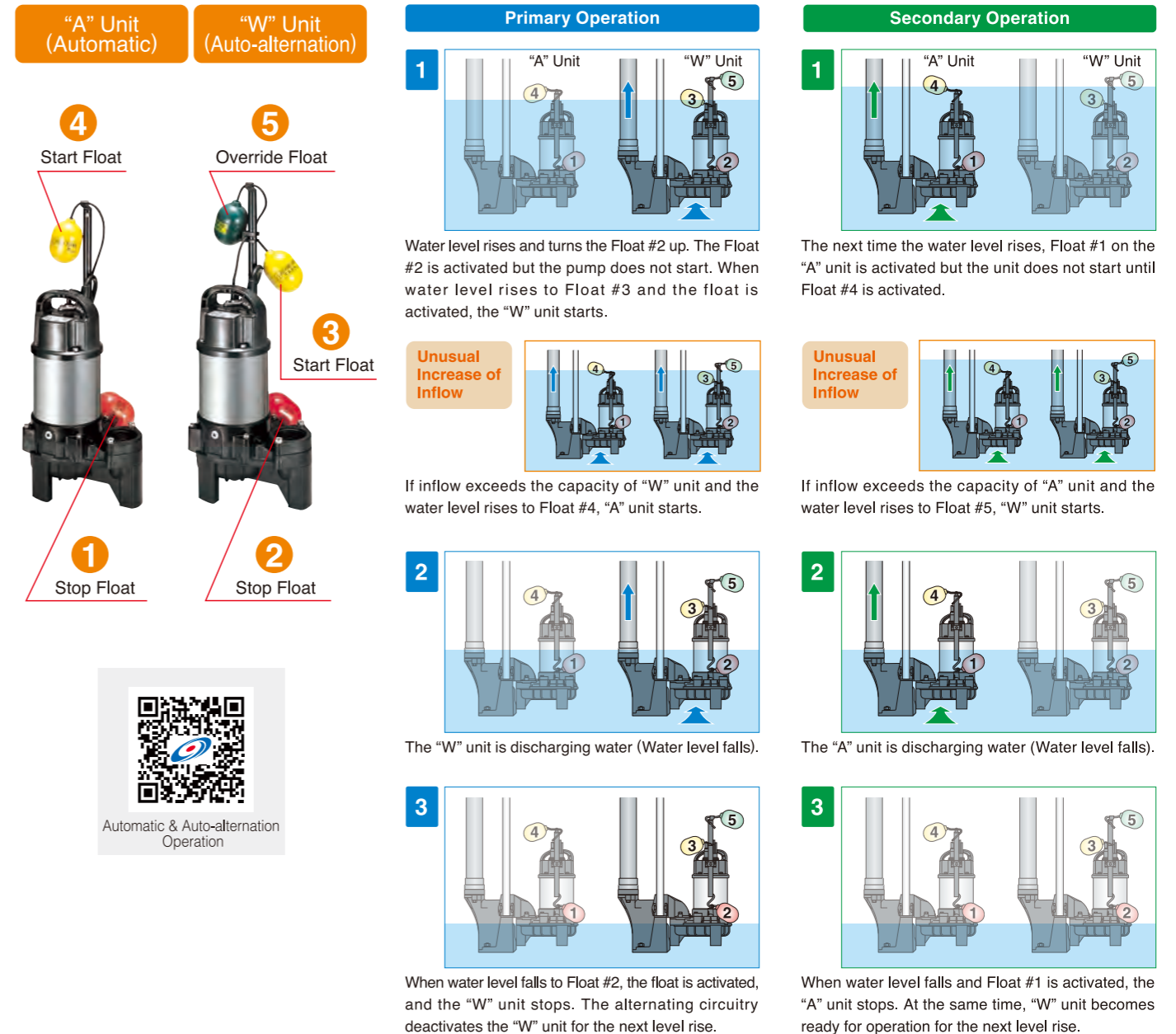

**Model
50PU2.4S**

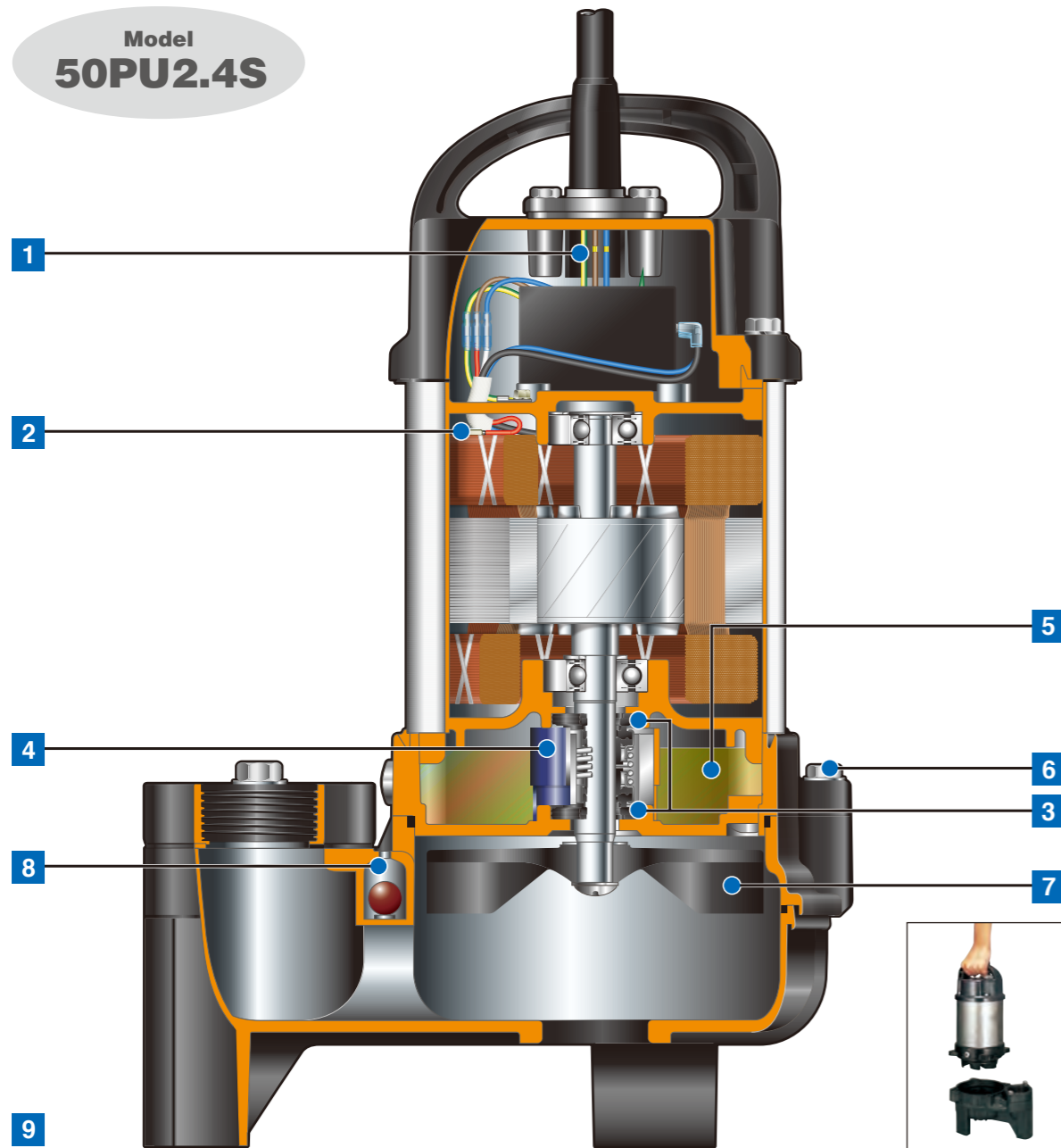

Back Pull-out Design

1 Anti-wicking Cable Entry

Prevents water incursion due to capillary action should the cable sheath be damaged or the end of cable submerged. Also prevents moist air from infiltrating the motor housing and condensation from forming inside the housing due to temperature differences between the housing and outside air.

2 Motor Protector

Miniature Thermal Protector (0.4 kW and below of single-phase motor)

Detects excess heat, therefore, protecting the pump against overheating and dry-running.

Circle Thermal Protector

Directly cuts the motor circuit if excessive heat builds up or overcurrent occurs in the motor.

3 Dual Inside Mechanical Seals with Silicon Carbide Face

Isolated in the oil chamber where a clean, non-corrosive and abrasion-free lubricating environment is maintained. Compared with the water-cooled outside mechanical seal, it reduces the risk of failure caused by dry-heating and adhering matter. The silicon carbide provides 5 times higher corrosion, wear and heat resistance than the tungsten carbide.

4 Oil Lifter

Provides lubrication and cooling of the seal faces down to 1/3 of normal oil level, thus maintaining a stable shaft sealing effect and prolonging seal life longer. The Oil Lifter is Tsurumi original design.

Special Resin

The resin used for the VANCS pump is not simple resin, but special resins produced by applying advanced treatment to elaborate compound material. Each pump component is made of resin that has been compounded at the optimum ratio for the role of the relevant parts. Therefore, the VANCS is more advantageous in terms of durability and corrosion resistance than simple resin pumps.

PPS-(MD+GF), PPS-GF - Excellent heat resistance and chemical resistance, and high mechanical strength

PPO-GF - Water-proofing, and resistance to acids and alkalis

PA+ABS-GF - Excellent mechanical strength, water-proofing, and resistance to acids and alkalis

ABS-GF - Water-proofing, and resistance to acids and alkalis

ABS - Excellent impact resistance, water-proofing, and resistance to acids and alkalis

Handle :

ABS or ABS-GF or PPS-(MD+GF) or PPS-GF

Motor Frame :

304 Stainless Steel or Titanium (TM series only)

Upper Pump Casing :

ABS-GF or PA+ABS-GF or PPO-GF

Lower Pump Casing :

ABS or ABS-GF or PA+ABS-GF

Head Cover :

PPS-GF or PPS-(MD+GF) or PPO-GF

Oil Casing :

PPS-GF or PPS-(MD+GF) or PPO-GF

Impeller :

PPO-GF or PA+ABS-GF

5 Liquid Paraffin Oil

This high-purity oil is commonly used in the cosmetics, pharmaceuticals and food processing equipment. Because it is a food grade lubricant, the pump can be safely used for water features in carp/koi ponds and fish farms.

6 Back Pull-out Design *Not available for OM-series

Enables the motor to be separated from the pump unit with the impeller attached, by removing the bolts between the oil casing and the pump casing. This design facilitates maintenance and inspection of the principal parts of the pump.

7 Resin Semi-vortex Impeller (PU, PN, PLS, TM and OM)

Resin Closed Impeller (PSF)

Resists wear caused by abrasive particles and enables the pump to maintain its original performance for an extended period of time.

8 Air Release Valve *Not available for PLS-series

Fitted into the pump casing to prevent the air lock. When air flows through the valve, the ball stays at the bottom, but when the pumped water starts to flow, the ball closes the outlet because of its buoyancy.

9 Rubber Foot (PLS and 1.5 kW or over of PU, PN, PSF and TM)

Prevents scratching of floor surface.

PU –Submersible Sewage Pumps–

The PU-series is a submersible portable vortex pump designed for raw sewage, wastewater, and liquid carrying solid matters. It is made of resin and 304 stainless steel and excellent in corrosion-resistance. The vortex mechanism provides practically unchokable operation in sewage pumping. Liquid paraffin is used for the lubricating oil, which widens the application of the pump to decorative waterfalls, fishponds, aquaculture, etc.



Discharge Bore mm	Model			Motor Output kW	Phase	Starting Method	Solids Passage mm	Dry Weight kg		Cable Length m
	Standard	Automatic	Auto-alternation					Standard	Auto & Auto-alternation	
40 (50)	40PU2.15S	40PUA2.15S	—	0.15	Single	Capacitor Run	35	5.3	6	5
40 (50)	40PU2.15	40PUA2.15	—	0.15	Three	D.O.L.	35	4.8	5.5	6
40	40PU2.25S	40PUA2.25S	40PUW2.25S	0.25	Single	Capacitor Run	35	7.1	7.8	5
40	40PU2.25	40PUA2.25	40PUW2.25	0.25	Three	D.O.L.	35	6.1	6.8	6
50	50PU2.4S	50PUA2.4S	50PUW2.4S	0.4	Single	Capacitor Run	35	7.1	7.8	5
50	50PU2.4	50PUA2.4	50PUW2.4	0.4	Three	D.O.L.	35	7	7.7	6
50	50PU2.75S	50PUA2.75S	—	0.75	Single	Capacitor Run	35	8.9	9.5	5
50	50PU2.75	50PUA2.75	50PUW2.75	0.75	Three	D.O.L.	35	8.3	9	6
80	80PU21.5	80PUA21.5	80PUW21.5	1.5	Three	D.O.L.	46	16	16.9	6
80	80PU22.2	80PUA22.2	80PUW22.2	2.2	Three	D.O.L.	46	22	23	6
80	80PU23.7	80PUA23.7	80PUW23.7	3.7	Three	D.O.L.	46	27	28	6

• Weights excluding cable

Performance Curves

Standard, Automatic and Auto-alternation models have the identical performance.

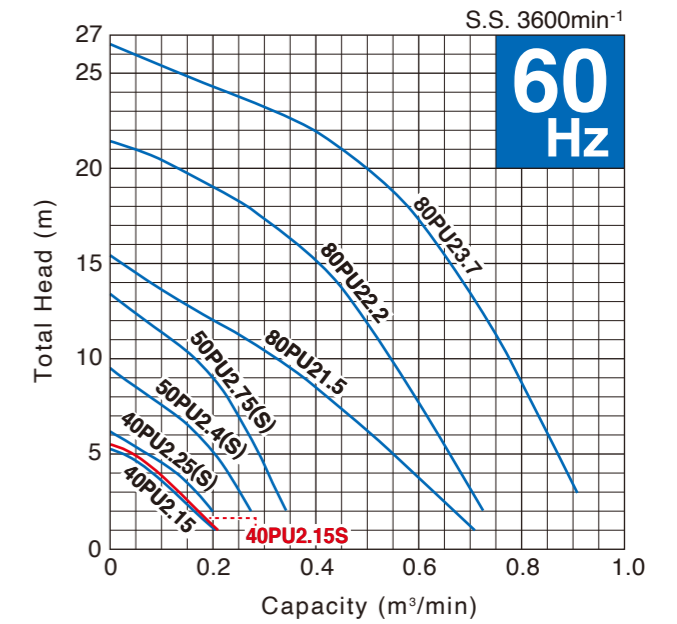
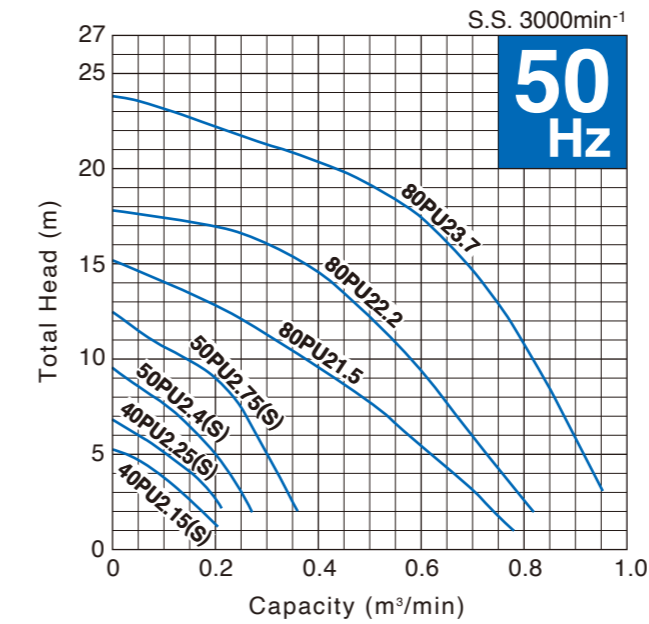

Dimensions

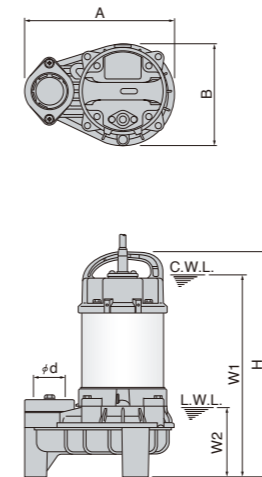

C.W.L.: Continuous Running Water Level
L.W.L.: Lowest Running Water Level

Unit: mm						
Model	d	A	B	H	W1	W2
40PU2.15S	40 (50)	203	136	376	315	100
40PU2.15	40 (50)	203	136	376	315	100
40PU2.25S	40	236	162	360	325	110
40PU2.25	40	236	162	349	310	110
50PU2.4S	50	236	162	360	325	110
50PU2.4	50	236	162	360	325	110
50PU2.75S	50	236	162	380	345	110
50PU2.75	50	236	162	374	335	110
80PU21.5	80	295	196	475	430	150
80PU22.2	80	311	212	583	520	155
80PU23.7	80	311	212	618	555	155

Applications

- Draining sewage from factory, residence, hotel, restaurant, etc.
- Pumping rainwater and springwater at a place where solid matters are likely to run into the water
- Transferring wastewater between the tanks at small-scale treatment facility
- Circulating water in waterscape garden (e.g. waterfall, fountain, koi pond, etc.)

Guide Rail Fitting

TOK Application Table

Model	Applicable Motor Output
TOK4-P	0.15 to 0.75 kW
TOK2-65	1.5 kW
TOK2-65T	2.2 to 3.7 kW

Accessories

- Duckfoot Bend
- Guide Hook
- Guide Support with Bolts & Nuts
- Lifting Chain with Shackles (4m for TOK4-P, 5m for TOK2-65 / 65T)

PN –Submersible Wastewater Pumps–

The PN-series is a submersible portable semi-vortex pump designed for handling wastewater and liquid carrying small solid matters. It is made of resin and 304 stainless steel and excellent in corrosion-resistance. The semi-vortex pump design with moderate solids passage provides efficient performance for versatile applications. Liquid paraffin is used for the lubricating oil, which widens the application of the pump to decorative waterfalls, fishponds, aquaculture, etc.



Discharge Bore mm	Model			Motor Output kW	Phase	Starting Method	Solids Passage mm	Dry Weight kg		Cable Length m
	Standard	Automatic	Auto-alternation					Standard	Auto & Auto-alternation	
40	40PN2.25S	40PNA2.25S	40PNW2.25S	0.25	Single	Capacitor Run	10	7.1	7.8	5
40	40PN2.25	40PNA2.25	40PNW2.25	0.25	Three	D.O.L.	10	6.1	6.8	6
50	50PN2.4S	50PNA2.4S	50PNW2.4S	0.4	Single	Capacitor Run	10	7.1	7.8	5
50	50PN2.4	50PNA2.4	50PNW2.4	0.4	Three	D.O.L.	10	7	7.7	6
50	50PN2.75S	50PNA2.75S	—	0.75	Single	Capacitor Run	10	8.9	9.4	5
50	50PN2.75	50PNA2.75	50PNW2.75	0.75	Three	D.O.L.	10	8.3	9	6
50	50PN21.5	50PNA21.5	50PNW21.5	1.5	Three	D.O.L.	20	15.9	16.8	6
80	80PN22.2	80PNA22.2	80PNW22.2	2.2	Three	D.O.L.	20	22	23	6
80	80PN23.7	80PNA23.7	80PNW23.7	3.7	Three	D.O.L.	20	27	28	6

• Weights excluding cable

Performance Curves

Standard, Automatic and Auto-alternation models have the identical performance.

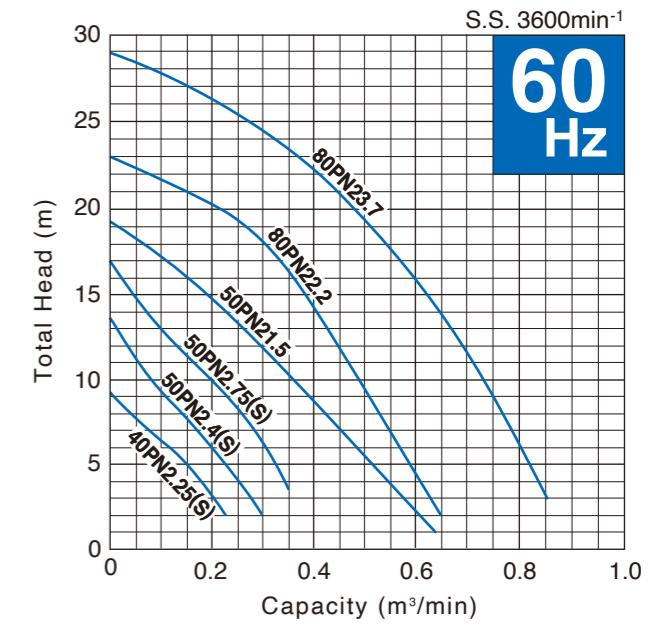
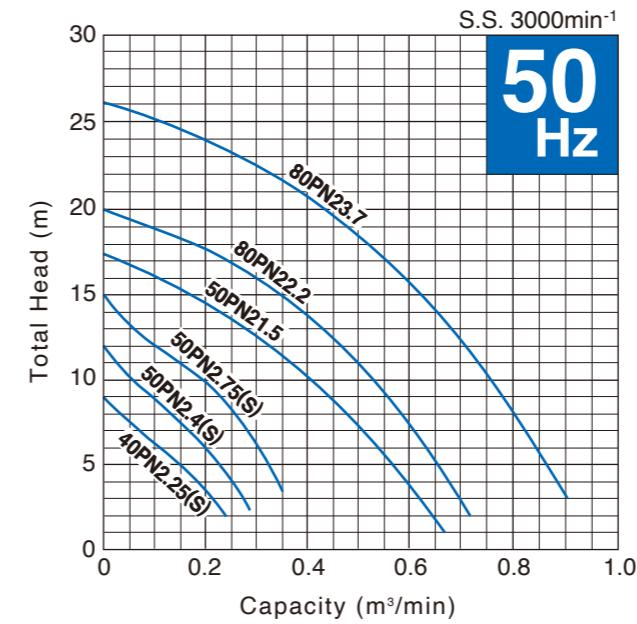

Dimensions

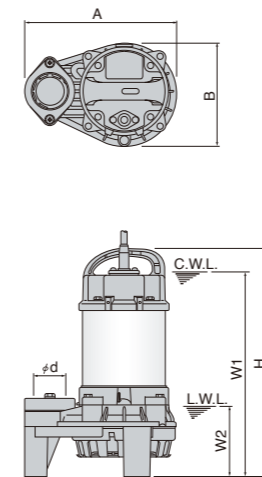

C.W.L.: Continuous Running Water Level
L.W.L.: Lowest Running Water Level

Unit: mm						
Model	d	A	B	H	W1	W2
40PN2.25S	40	236	162	360	325	110
40PN2.25	40	236	162	349	310	110
50PN2.4S	50	236	162	360	325	110
50PN2.4	50	236	162	360	325	110
50PN2.75S	50	236	162	380	345	110
50PN2.75	50	236	162	374	335	110
50PN21.5	50	295	196	435	390	110
80PN22.2	80	311	212	559	500	130
80PN23.7	80	311	212	594	535	130

Applications

- Draining wastewater from residence, hotel, restaurant, etc.
- Pumping rainwater and springwater from basement
- Circulating water in waterscape garden (e.g. waterfall, fountain, koi pond, etc.)

Guide Rail Fitting

TOK Application Table

Model	Applicable Motor Output
TOK4-P	0.25 to 0.75 kW
TOK2-65	1.5 kW
TOK2-65T	2.2 to 3.7 kW

Accessories

- Duckfoot Bend
- Guide Hook
- Guide Support with Bolts & Nuts
- Lifting Chain with Shackles (4m for TOK4-P, 5m for TOK2-65 / 65T)

PSF –Submersible Wastewater Pumps (High Head)–

The PSF-series is a submersible portable high head drainage pump designed for handling wastewater and liquid carrying few solid matters. It is made of resin and 304 stainless steel and excellent in corrosion-resistance. Liquid paraffin is used for the lubricating oil, which widens the application of the pump to decorative waterfalls, fishponds, aquaculture, etc.



Discharge Bore mm	Model			Motor Output kW	Phase	Starting Method	Solids Passage mm	Dry Weight kg		Cable Length m
	Standard	Automatic	Auto-alternation					Standard	Auto & Auto-alternation	
40	40PSF2.25S	40PSFA2.25S	40PSFW2.25S	0.25	Single	Capacitor Run	8	7.3	7.9	5
40	40PSF2.25	40PSFA2.25	40PSFW2.25	0.25	Three	D.O.L.	8	6.2	6.9	6
40	40PSF2.4S	40PSFA2.4S	40PSFW2.4S	0.4	Single	Capacitor Run	8	7.3	7.9	5
40	40PSF2.4	40PSFA2.4	40PSFW2.4	0.4	Three	D.O.L.	8	7.1	7.8	6
50	50PSF2.75	50PSFA2.75	50PSFW2.75	0.75	Three	D.O.L.	8	8.4	9.1	6
50	50PSF21.5	50PSFA21.5	50PSFW21.5	1.5	Three	D.O.L.	13	16	16.9	6
65	65PSF22.2	65PSFA22.2	65PSFW22.2	2.2	Three	D.O.L.	13	22	23	6
65	65PSF23.7	65PSFA23.7	65PSFW23.7	3.7	Three	D.O.L.	13	27	28	6

• Weights excluding cable

Performance Curves

Standard, Automatic and Auto-alternation models have the identical performance.

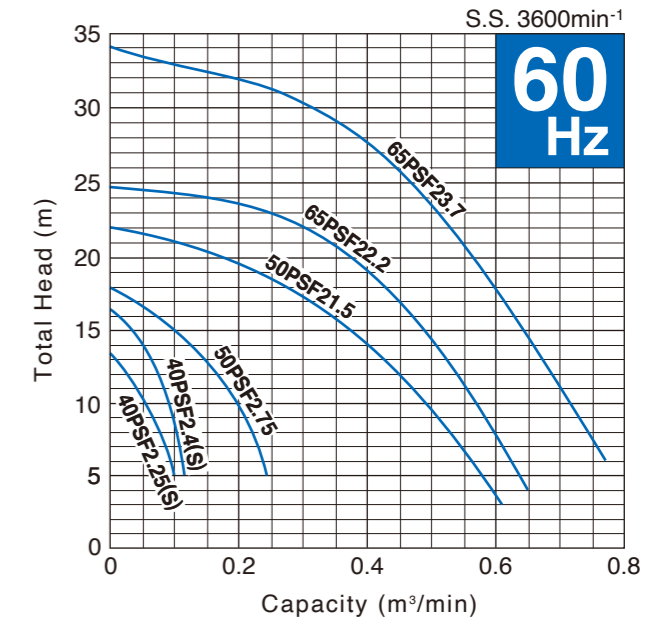
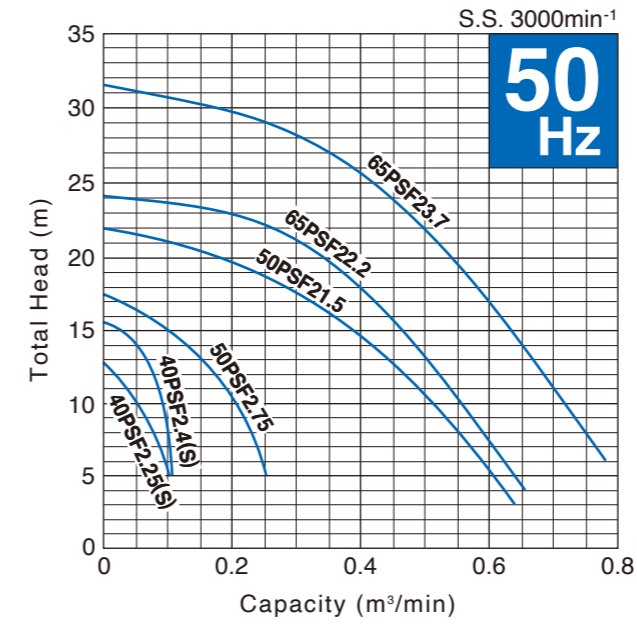

Dimensions

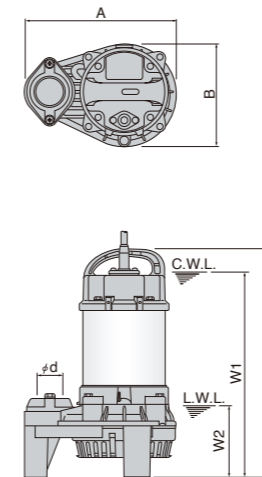

C.W.L.: Continuous Running Water Level
L.W.L.: Lowest Running Water Level

Unit: mm						
Model	d	A	B	H	W1	W2
40PSF2.25S	40	236	162	360	325	110
40PSF2.25	40	236	162	349	310	110
40PSF2.4S	40	236	162	360	325	110
40PSF2.4	40	236	162	360	325	110
50PSF2.75	50	236	162	374	335	110
50PSF21.5	50	295	196	435	390	110
65PSF22.2	65	311	212	559	500	130
65PSF23.7	65	311	212	594	535	130

Applications

- Draining treated water at small-scale wastewater treatment facility
- Pumping rainwater and springwater from basement
- Supplying treated water for defoaming at small-scale wastewater treatment facility
- Circulating water in waterscape garden (e.g. waterfall, fountain, koi pond, etc.)

Guide Rail Fitting

TOK Application Table

Model	Applicable Motor Output
TOK4-P	0.25 to 0.75 kW
TOK2-65	1.5 kW
TOK2-65T	2.2 to 3.7 kW

Accessories

- Duckfoot Bend
- Guide Hook
- Guide Support with Bolts & Nuts
- Lifting Chain with Shackles (4m for TOK4-P, 5m for TOK2-65 / 65T)

PLS –Submersible Wastewater Pumps (Horizontal)–

The PLS-series is a submersible portable horizontal semi-vortex pump designed for handling wastewater and liquid carrying small solid matters. It is made of resin and 304 stainless steel and is excellent in corrosion-resistance. Because of the horizontal design, the continuous running water level is lower than conventional vertical types, and it can be used in a shallow or narrow sump. Liquid paraffin is used for the lubricating oil, which widens the application of the pump to decorative waterfalls, fishponds, aquaculture, etc.



Discharge Bore mm	Model	Motor Output kW	Phase	Starting Method	Solids Passage mm	Dry Weight kg	Cable Length m
50	50PLS2.15S	0.15	Single	Capacitor Run	38 (10)	5.2	5
50	50PLS2.4S	0.4	Single	Capacitor Run	24 (10)	6.7	5
50	50PLS2.75S	0.75	Single	Capacitor Run	24 (10)	8.6	5

• Figure in () shows the solids passage of the pump with a strainer.
• Weights excluding cable

Comparison of Continuous Running Water Level

The PLS-series is suitable for installation in relatively shallow tanks and ponds due to its low continuous running water level.

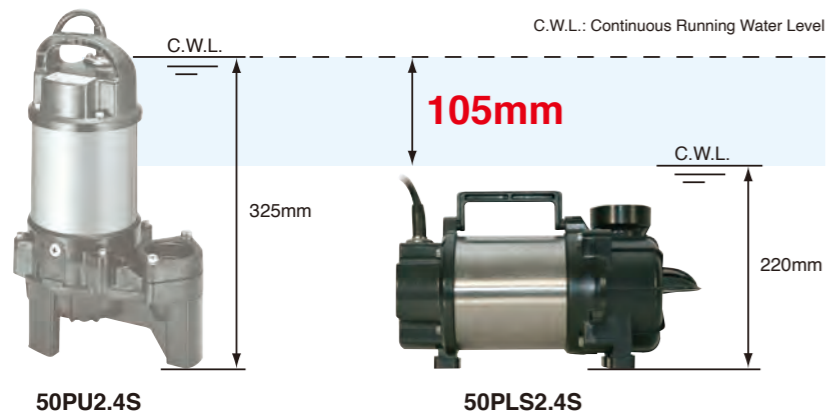

Performance Curves

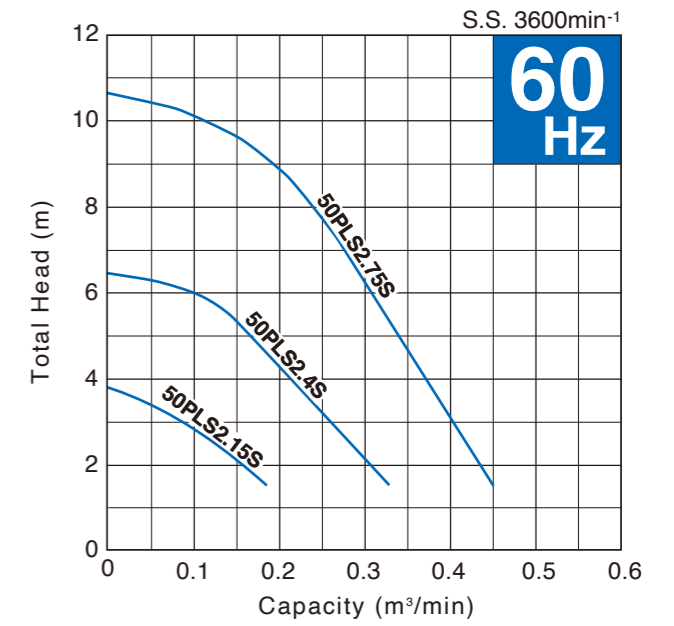
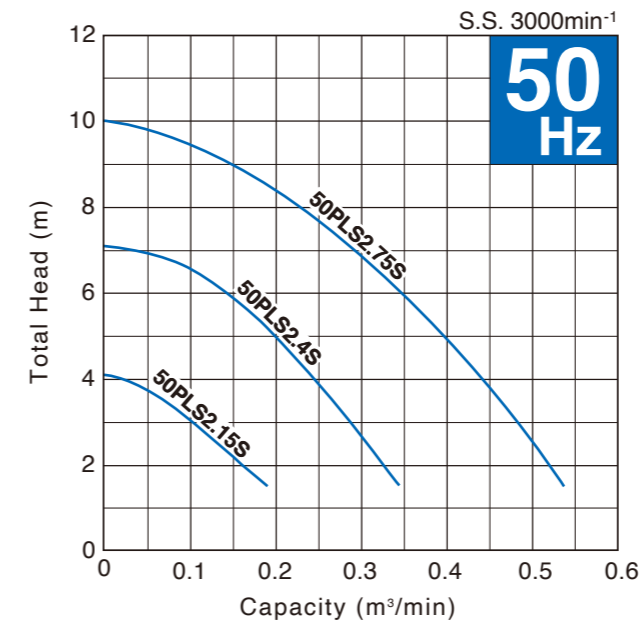

Dimensions

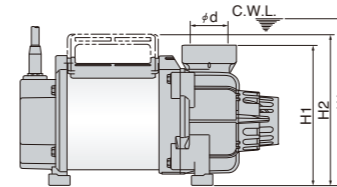
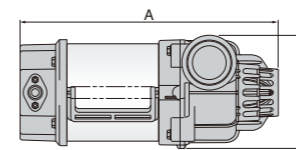

C.W.L.: Continuous Running Water Level

Unit: mm						
Model	d	A	B	H1	H2	W
50PLS2.15S	50	329	142	180	—	220
50PLS2.4S	50	342	150	185	200	220
50PLS2.75S	50	362	150	185	201	310

Applications

- Pumping rainwater and springwater at a place where solid matters are likely to run into the water
- Transferring wastewater between the tanks at small-scale treatment facility
- Circulating water in waterscape garden (e.g. waterfall, fountain, koi pond, etc.)



TM –Submersible Seawater Pumps–

The TM-series is a submersible titanium portable pump designed for handling seawater. It is made of titanium and resin. Since titanium has a superb corrosion resistance against seawater, it is suitable for various applications where seawater is used. Liquid paraffin is used for the lubricating oil, which makes it ideal for saltwater aquaculture.



Discharge Bore mm	Model		Motor Output kW	Phase	Starting Method	Solids Passage mm	Dry Weight kg		Cable Length m
	Standard	Automatic					Standard	Automatic	
40	40TM2.25S	40TMA2.25S	0.25	Single	Capacitor Run	10	6.7	7.2	5
40	40TM2.25	40TMA2.25	0.25	Three	D.O.L.	10	5.7	6.2	6
50	50TM2.4S	50TMA2.4S	0.4	Single	Capacitor Run	10	6.7	7.2	5
50	50TM2.4	50TMA2.4	0.4	Three	D.O.L.	10	6.6	7.1	6
50	50TM2.75S	50TMA2.75S	0.75	Single	Capacitor Run	10	8.6	9.1	5
50	50TM2.75	50TMA2.75	0.75	Three	D.O.L.	10	7.8	8.4	6
50	50TM21.5	50TMA21.5	1.5	Three	D.O.L.	20	14.9	15.6	6
80	80TM22.2	80TMA22.2	2.2	Three	D.O.L.	20	21	22	6
80	80TM23.7	80TMA23.7	3.7	Three	D.O.L.	20	26	27	6

• Weights excluding cable

Corrosion Tests (in Seawater / 6 months)



The TM-series submersible titanium pumps for seawater use titanium for all metal parts in contact with the liquid. Titanium has a much stronger oxide film on its surface than stainless steel and is therefore highly corrosion resistant, even under conditions of high chloride ion concentration, such as seawater.

Performance Curves

Standard and Automatic models have the identical performance.

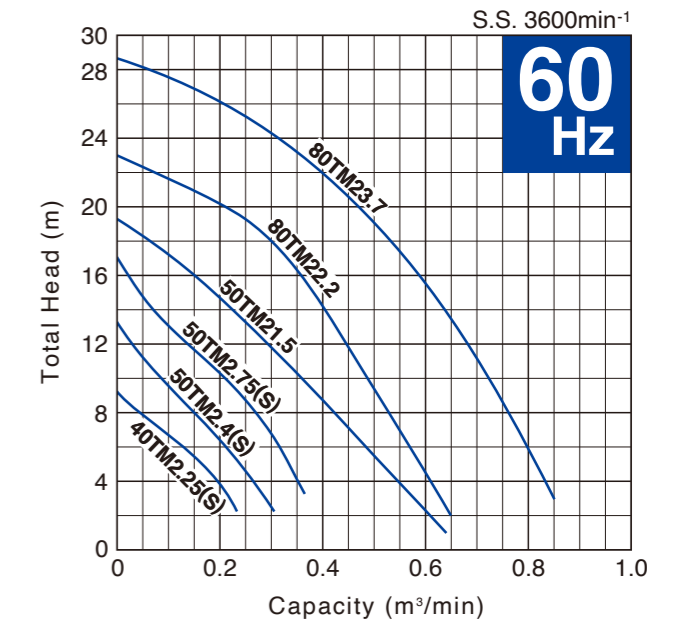
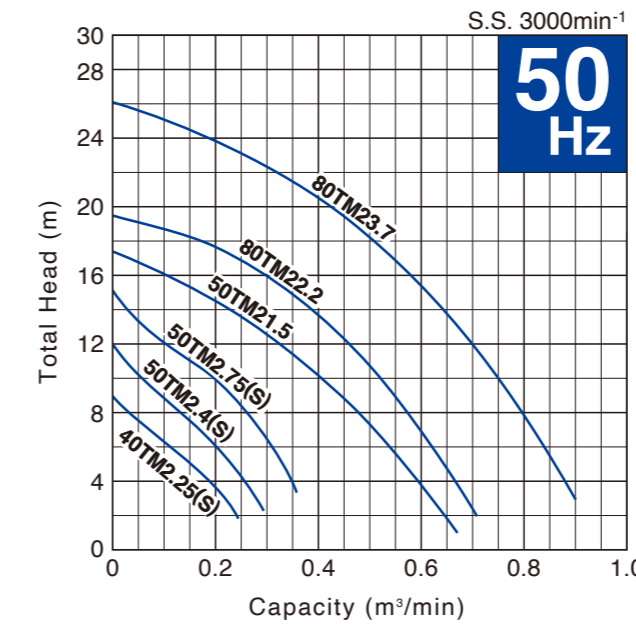

Dimensions

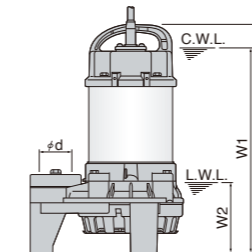
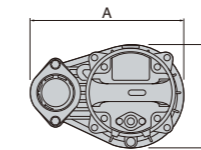

C.W.L.: Continuous Running Water Level
L.W.L.: Lowest Running Water Level

Model	d	A	B	H	W1	W2
40TM2.25S	40	236	162	360	325	110
40TM2.25	40	236	162	349	310	110
50TM2.4S	50	236	162	360	325	110
50TM2.4	50	236	162	360	325	110
50TM2.75S	50	236	162	380	345	110
50TM2.75	50	236	162	374	335	110
50TM21.5	50	295	196	435	390	110
80TM22.2	80	311	212	559	500	130
80TM23.7	80	311	212	594	535	130

Unit: mm

Applications

- Pumping seawater from bilge and pit of vessel
- Supplying seawater to aquarium
- Circulating seawater in breeding pond



OM –Submersible Wastewater Pumps (Economic)–

The OM-series is a submersible portable semi-vortex pump designed for handling household wastewater and liquid carrying small solid matters. The semi-vortex pump design with moderate solids passage provides efficient performance for versatile applications. Liquid paraffin is used for the lubricating oil, which widens the application of the pump to decorative waterfalls, fishponds, aquaculture, etc.



Discharge Bore mm	Model		Motor Output kW	Phase	Starting Method	Solids Passage mm	Dry Weight kg		Cable Length m
	Standard	Automatic					Standard	Automatic	
32	OM5	OMA5	0.15	Single	Capacitor Run	10	5.1	5.3	5

• Weights excluding cable

Automatic Operation (OMA)

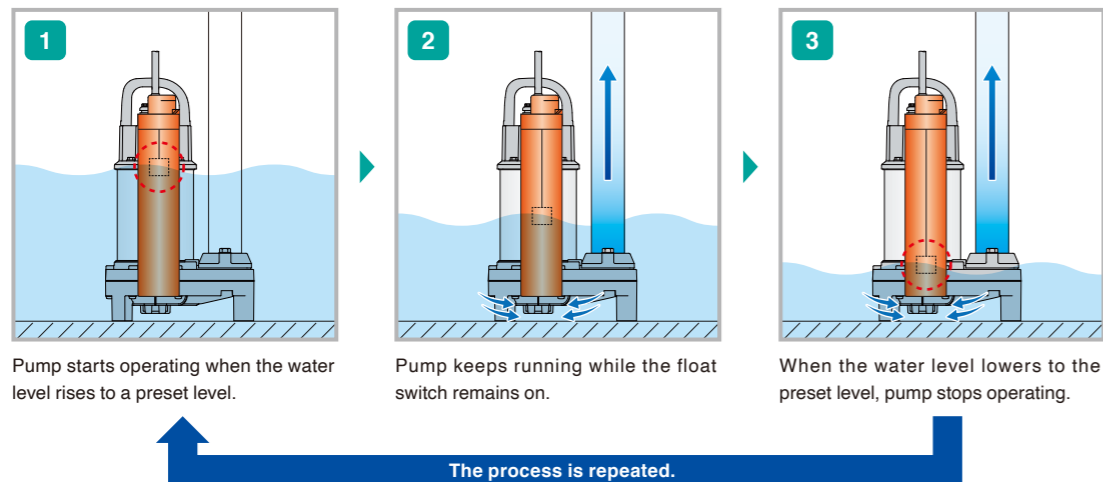

Performance Curves

Standard and Automatic models have the identical performance.

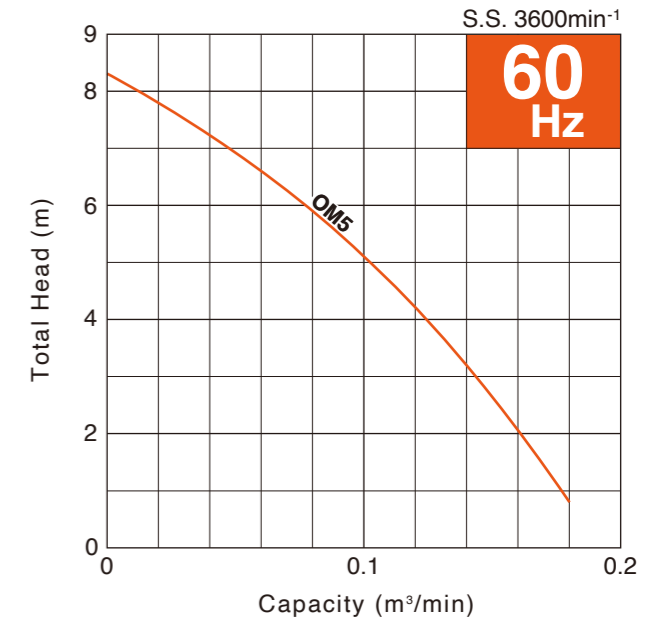
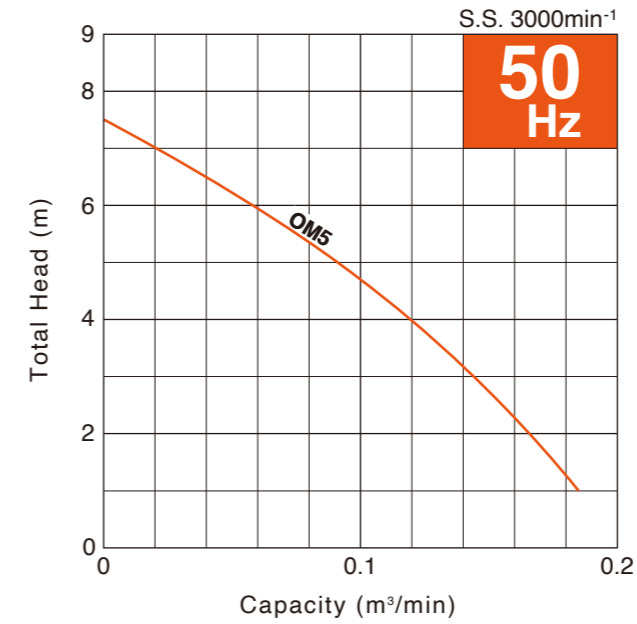

Dimensions

Unit: mm

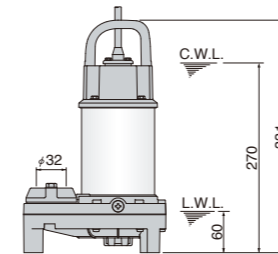
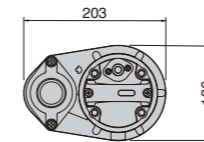

C.W.L.: Continuous Running Water Level
L.W.L.: Lowest Running Water Level

Applications

- Pumping rainwater and springwater from basement
- Circulating water in waterscape garden (e.g. waterfall, fountain, koi pond, etc.)



Specifications

		PU									PU			PN								
		40PU2.15S (40PUA2.15S)	40PU2.15 (40PUA2.15)	40PU2.25S (40PUA2.25S) (40PUW2.25S)	40PU2.25 (40PUA2.25) (40PUW2.25)	50PU2.4S (50PUA2.4S) (50PUW2.4S)	50PU2.4 (50PUA2.4) (50PUW2.4)	50PU2.75S (50PUA2.75S)	50PU2.75 (50PUA2.75) (50PUW2.75)		80PU21.5 (80PUA21.5) (80PUW21.5)	80PU22.2 (80PUA22.2) (80PUW22.2)	80PU23.7 (80PUA23.7) (80PUW23.7)	40PN2.25S (40PNA2.25S) (40PNW2.25S)	40PN2.25 (40PNA2.25) (40PNW2.25)	50PN2.4S (50PNA2.4S) (50PNW2.4S)	50PN2.4 (50PNA2.4) (50PNW2.4)	50PN2.75S (50PNA2.75S)	50PN2.75 (50PNA2.75) (50PNW2.75)	50PN21.5 (50PNA21.5) (50PNW21.5)	80PN22.2 (80PNA22.2) (80PNW22.2)	80PN23.7 (80PNA23.7) (80PNW23.7)
PUMP	Discharge Bore mm	40 (50)		40		50					80			40		50			80			
	Discharge Connection	Threaded Oval Flange									Threaded Oval Flange											
	Solids Passage mm	35									46			10			20					
	Impeller	Vortex									Vortex											
		Glass-fiber Reinforced Resin (PPO-GF)									Glass-fiber Reinforced Resin (PPO-GF)	Glass-fiber Reinforced Resin (PA+ABS-GF)			Glass-fiber Reinforced Resin (PPO-GF)						Glass-fiber Reinforced Resin (PA+ABS-GF)	
	Casing	Upper	Glass-fiber Reinforced Resin (PPO-GF)		Glass-fiber Reinforced Resin (ABS-GF)							Glass-fiber Reinforced Resin (PA+ABS-GF)			Glass-fiber Reinforced Resin (ABS-GF)			Glass-fiber Reinforced Resin (PA+ABS-GF)				
		Lower	Glass-fiber Reinforced Resin (ABS)									Glass-fiber Reinforced Resin (PA+ABS-GF)			Glass-fiber Reinforced Resin (ABS)			Glass-fiber Reinforced Resin (PA+ABS-GF)				
Shaft Seal	Dual Inside Mechanical Seals (with Oil Lifter)									Dual Inside Mechanical Seals (with Oil Lifter)												
	Silicon Carbide									Silicon Carbide												
MOTOR	Type	Dry-type Submersible Induction Motor									Dry-type Submersible Induction Motor											
	Output kW	0.15		0.25		0.4		0.75			1.5	2.2	3.7	0.25		0.4		0.75		1.5	2.2	3.7
	Phase	Single	Three	Single	Three	Single	Three	Single	Three		Three			Single	Three	Single	Three	Single	Three			
	Pole	2									2											
	Speed (S.S.) 50/60Hz min ⁻¹	3000/3600									3000/3600											
	Insulation	E									E											
	Starting Method	Capacitor Run	D.O.L.	Capacitor Run	D.O.L.	Capacitor Run	D.O.L.	Capacitor Run	D.O.L.		D.O.L.			Capacitor Run	D.O.L.	Capacitor Run	D.O.L.	Capacitor Run	D.O.L.			
	Motor Protector (built-in)	MTP	CTP	MTP	CTP	MTP	CTP				CTP			MTP	CTP	MTP	CTP					
	Lubricant ml	135		240							500	680		240			500	680				
		Liquid Paraffin (ISO VG32)									Liquid Paraffin (ISO VG32)											
	Frame	304 Stainless Steel									304 Stainless Steel											
Shaft	316 Stainless Steel		304 Stainless Steel							304 Stainless Steel												
Power Cable m	5	6	5	6	5	6	5	6		6			5	6	5	6	5	6				
	PVC									PVC												
Rubber Foot	—									Nitrile Butadien Rubber			—			Nitrile Butadien Rubber						
Automatic Control Device	Float Switch									Float Switch												
Dry Weight*	Standard kg	5.3	4.8	7.1	6.1	7.1	7	8.9	8.3		16	22	27	7.1	6.1	7.1	7	8.9	8.3	15.9	22	27
	Auto & Auto-alternation kg	6	5.5	7.8	6.8	7.8	7.7	9.5	9		16.9	23	28	7.8	6.8	7.8	7.7	9.4	9	16.8	23	28

* All weights excluding cable

Specifications

		PSF								PLS			TM								OM			
		40PSF2.25S (40PSFA2.25S) (40PSFW2.25S)	40PSF2.25 (40PSFA2.25) (40PSFW2.25)	40PSF2.4S (40PSFA2.4S) (40PSFW2.4S)	40PSF2.4 (40PSFA2.4) (40PSFW2.4)	50PSF2.75 (50PSFA2.75) (50PSFW2.75)	50PSF2.15 (50PSFA2.15) (50PSFW2.15)	65PSF2.2 (65PSFA2.2) (65PSFW2.2)	65PSF2.7 (65PSFA2.7) (65PSFW2.7)	50PLS2.15S	50PLS2.4S	50PLS2.75S	40TM2.25S (40TMA2.25S)	40TM2.25 (40TMA2.25)	50TM2.4S (50TMA2.4S)	50TM2.4 (50TMA2.4)	50TM2.75S (50TMA2.75S)	50TM2.75 (50TMA2.75)	50TM2.15 (50TMA2.15)	80TM2.2 (80TMA2.2)	80TM2.7 (80TMA2.7)	OM5 (OMA5)		
PUMP	Discharge Bore mm	40				50				65			50			40			50			80		32
	Discharge Connection	Threaded Oval Flange								Threaded Flange			Threaded Oval Flange								Threaded Flange			
	Solids Passage mm	8				13				38 (10)*1			24 (10)*1			10			20			10		
	Impeller	Closed								Vortex														
		Glass-fiber Reinforced Resin (PPO-GF)				Glass-fiber Reinforced Resin (PA+ABS-GF)				Glass-fiber Reinforced Resin (PPO-GF)				Glass-fiber Reinforced Resin (PA+ABS-GF)		Glass-fiber Reinforced Resin (PPO-GF)								
	Casing	Upper	Glass-fiber Reinforced Resin (ABS-GF)				Glass-fiber Reinforced Resin (PA+ABS-GF)				Glass-fiber Reinforced Resin (ABS-GF)			Glass-fiber Reinforced Resin (PA+ABS-GF)			Glass-fiber Reinforced Resin (PPO-GF)							
		Lower	Glass-fiber Reinforced Resin (ABS)				Glass-fiber Reinforced Resin (PA+ABS-GF)				Glass-fiber Reinforced Resin (ABS)			Glass-fiber Reinforced Resin (PA+ABS-GF)			Glass-fiber Reinforced Resin (ABS)							
Shaft Seal	Dual Inside Mechanical Seals (with Oil Lifter)								Dual Inside Mechanical Seals (with Oil Lifter)															
	Silicon Carbide								Silicon Carbide															
MOTOR	Type	Dry-type Submersible Induction Motor								Dry-type Submersible Induction Motor														
	Output kW	0.25		0.4		0.75	1.5	2.2	3.7	0.15	0.4	0.75	0.25		0.4		0.75		1.5	2.2	3.7	0.15		
	Phase	Single	Three	Single	Three				Single			Three	Single	Three	Single	Three			Single					
	Pole	2								2														
	Speed (S.S.) 50/60Hz min ⁻¹	3000/3600								3000/3600														
	Insulation	E								E														
	Starting Method	Capacitor Run	D.O.L.	Capacitor Run	D.O.L.				Capacitor Run			D.O.L.	Capacitor Run	D.O.L.	Capacitor Run	D.O.L.			Capacitor Run					
	Motor Protector (built-in)	MTP	CTP	MTP	CTP				MTP		CTP	MTP	CTP	MTP	CTP			MTP						
	Lubricant ml	240				500	680			125	240			500	680		135							
		Liquid Paraffin (ISO VG32)								Liquid Paraffin (ISO VG32)														
	Frame	304 Stainless Steel								304 Stainless Steel			Titanium					304 Stainless Steel						
	Shaft	304 Stainless Steel								³¹⁶ Stainless Steel	304 Stainless Steel		Titanium					³¹⁶ Stainless Steel						
Power Cable m	5	6	5	6				5			6	5	6	5	6			5						
	PVC								PVC															
Rubber Foot	—				Nitrile Butadien Rubber				Nitrile Butadien Rubber			—			Nitrile Butadien Rubber			—						
Automatic Control Device	Float Switch								—			Float Switch					Cylindrical Float Switch							
Dry Weight** kg	Standard	7.3	6.2	7.3	7.1	8.4	16	22	27	5.2	6.7	8.6	6.7	5.7	6.7	6.6	8.6	7.8	14.9	21	26	5.1		
	Auto & Auto-alternation	7.9	6.9	7.9	7.8	9.1	16.9	23	28	—			7.2	6.2	7.2	7.1	9.1	8.4	15.6	22	27	5.3		

*1 Figure in () shows the solids passage of the pump with a strainer
 ** All weights excluding cable



We reserve the right to change the specifications and designs without prior notice. The OO series and model OO are indicated with our series/model codes in this catalog.

**TSURUMI
MANUFACTURING CO., LTD.**

Your Dealer